

Data sheet | Item number: 750-557

4-channel analog output;  $\pm 10$  VDC; light gray

[www.wago.com/750-557](http://www.wago.com/750-557)



RoHS  Compliant

[BOMcheck.net](https://www.bomcheck.net)

Color:

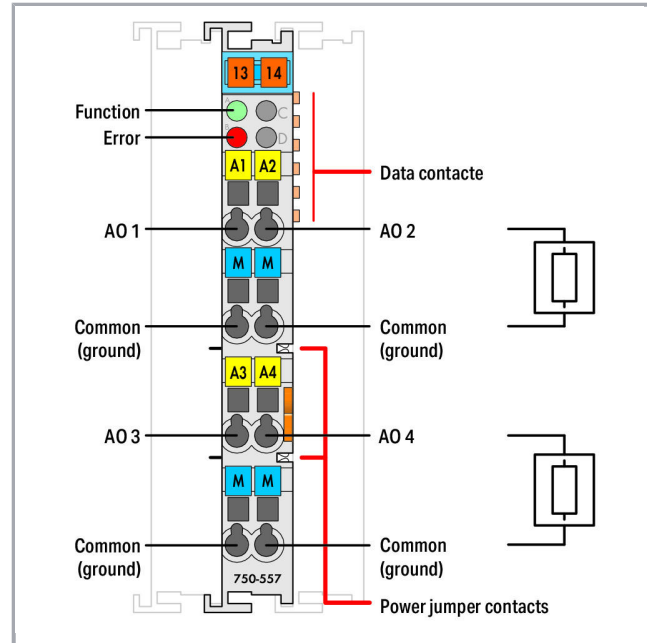

Subject to changes. Please also observe the further product documentation!

WAGO Kontakttechnik GmbH & Co. KG  
Hansastr. 27  
32423 Minden  
Phone: +49571 887-0 | Fax: +49571 887-169  
Email: [info.de@wago.com](mailto:info.de@wago.com) | Web: [www.wago.com](http://www.wago.com)

Do you have any questions about our products?  
We are always happy to take your call at +49 (571) 887-44222.

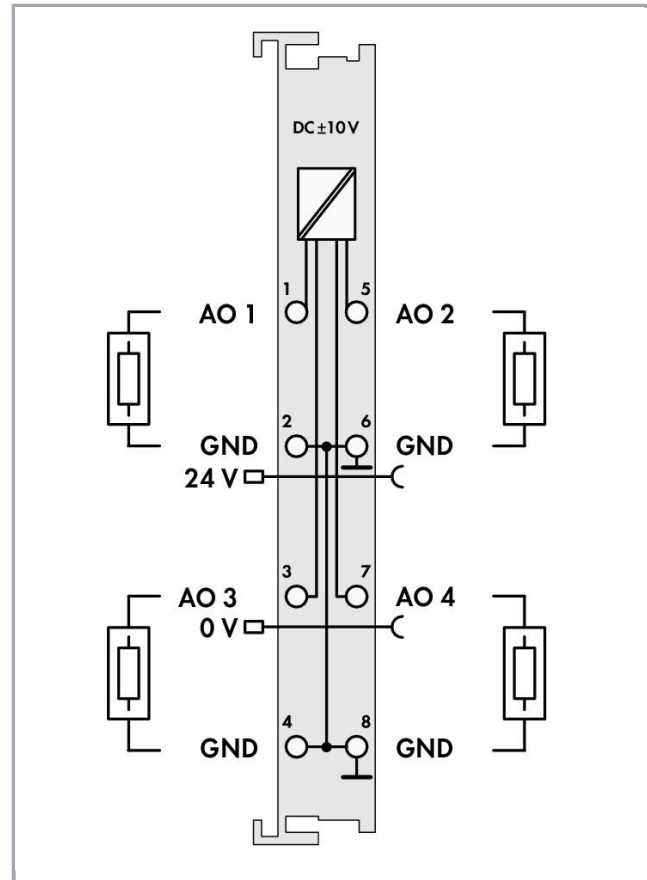
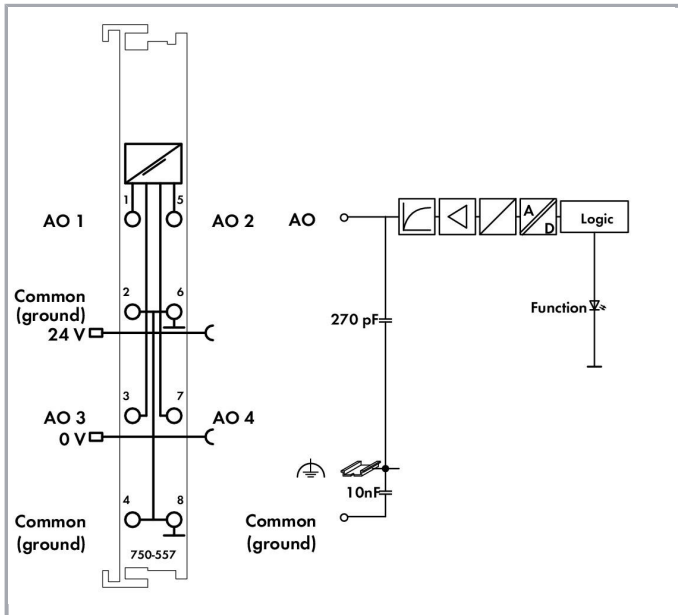

## Item description

This analog output module generates standard  $\pm 10$  V signals.

The output signal is electrically isolated and transmitted with a resolution of 12 bits.

The internal system supply powers the module.

The module's output channels have a common ground potential.

## Data

### Technical Data

Number of analog outputs	4
Total number of channels (module)	4
Signal type	Voltage
Voltage signal type	DC -10 ... +10 V
Actuator connection	4 x (2-wire)
Resolution [bit]	12 Bit

Subject to changes. Please also observe the further product documentation!



Data width	4 x 16-bit data; 4 x 8-bit control/status (optional)
Load impedance (voltage output)	≥ 5 kΩ
Conversion time (typ. ≤)	10 ms
Measurement error (reference temperature)	25 °C
Measurement error – deviation (max.) from the upper-range value	0.1 %
Temperature error (max.) of the upper-range value	0.01 %/K
Recovery time (typ.)	100 ms
Supply voltage (system)	DC 5 V; via data contacts
Power consumption (5 V system supply)	125 mA
Supply voltage (field)	DC 24 V (-25 ... +30 %); via power jumper contacts (power supply via blade contact; transmission via spring contact)
Isolation	500 V system/field
Number of incoming power jumper contacts	2
Number of outgoing power jumper contacts	2
Current carrying capacity (power jumper contacts)	10 A

### Connection data

Connection technology: inputs/outputs	8 x CAGE CLAMP®
Connection type (1)	Inputs/Outputs
Solid conductor	0,08 ... 2,5 mm <sup>2</sup> / 28 ... 14 AWG
Fine-stranded conductor	0,08 ... 2,5 mm <sup>2</sup> / 28 ... 14 AWG
Strip length	8 ... 9 mm / 0.31 ... 0.35 inch

### Geometrical Data

Width	12 mm / 0.472 inch
Height	100 mm / 3.937 inch
Depth	69,8 mm / 2.748 inch
Depth from upper edge of DIN-rail	62,6 mm / 2.465 inch

### Mechanical data

Mounting type	DIN-35 rail
---------------	-------------

### Material Data

Color	light gray
Housing material	Polycarbonate, polyamide 6.6
Fire load	1.219 MJ

Subject to changes. Please also observe the further product documentation!

Weight	51 g
Conformity marking	CE

## Environmental Requirements

Surrounding air temperature (operation)	0 ... 55 °C
Surrounding air temperature (storage)	-40 ... 85 °C
Protection type	IP20
Pollution degree (5)	2 per IEC 61131-2
Operating altitude	0 ... 2000 m
Mounting position	horizontal (standing/lying); vertical
Relative humidity (without condensation)	95 %
Vibration resistance	4g per IEC 60068-2-6
Shock resistance	15g per IEC 60068-2-27
EMC immunity to interference	per EN 61000-6-2, marine applications
EMC emission of interference	per EN 61000-6-4, marine applications
Exposure to pollutants	Per IEC 60068-2-42 and IEC 60068-2-43
Permissible H <sub>2</sub> S contaminant concentration at a relative humidity 75 %	10 ppm
Permissible SO <sub>2</sub> contaminant concentration at a relative humidity 75 %	25 ppm

## Commercial data

Product Group	15 (Remote I/O)
Packaging type	BOX
Country of origin	DE
GTIN	4045454475437
Customs tariff number	85389099990

## Approvals / Certificates

### Ex-Approvals

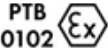
Logo	Approval	Additional Approval Text	Certificate name
	ATEX TUEV Nord Cert GmbH	EN 60079-0	TÜV 07 ATEX 554086 X en.
	TUEV Nord TUEV Nord Cert GmbH	IEC 60079-0	IECEX TUN

Subject to changes. Please also observe the further product documentation!





UL  
Underwriters Laboratories Inc. (HAZARDOUS  
LOCATIONS)







UL 121201

E198726  
Sec.1

## Country specific Approvals

Logo	Approval	Additional Approval Text	Certificate name
	KC National Radio Research Agency	Article 58-2, Clause 3	MSIP- REM-W43- AOM750

## Ship Approvals

Logo	Approval	Additional Approval Text	Certificate name
	ABS American Bureau of Shipping	-	19- HG1821926
	BV Bureau Veritas S.A.	-	13453/DO BV
	DNV GL Det Norske Veritas, Germanischer Lloyd	-	TAA0000194
	KR Korean Register of Shipping	-	KR HMB05880- AC001
	LR Lloyds Register	-	02/20026 (E6)
	NK Nippon Kaiji Kyokai	-	TA17255M

Subject to changes. Please also observe the further product documentation!

WAGO Kontakttechnik GmbH & Co. KG  
Hansastr. 27  
32423 Minden  
Phone: +49571 887-0 | Fax: +49571 887-169  
Email: [info.de@wago.com](mailto:info.de@wago.com) | Web: [www.wago.com](http://www.wago.com)

Do you have any questions about our products?  
We are always happy to take your call at +49 (571) 887-44222.



**PRS**  
Polski Rejestr Statków

-

TE/2236  
/880590/19



**RINA**  
RINA Germany GmbH

-

ELE066419XG







### UL-Approvals

Logo	Approval	Additional Approval Text	Certificate name
	<b>UL</b> UL International Netherlands B.V. (ORDINARY LOCATIONS)	UL 508	E175199 Sec.1

### Counterpart

### Compatible products





#### Carrier rail

	<b>Item no.: 210-112</b> Steel carrier rail; 35 x 7.5 mm; 1 mm thick; 2 m long; slotted; according to EN 60715; "Hole width 25 mm	<a href="http://www.wago.com/210-112">www.wago.com/210-112</a>
	<b>Item no.: 210-113</b> Steel carrier rail; 35 x 7.5 mm; 1 mm thick; 2 m long; unslotted; according to EN 60715	<a href="http://www.wago.com/210-113">www.wago.com/210-113</a>
	<b>Item no.: 210-114</b> Steel carrier rail; 35 x 15 mm; 1.5 mm thick; 2 m long; unslotted; similar to EN 60715	<a href="http://www.wago.com/210-114">www.wago.com/210-114</a>
	<b>Item no.: 210-115</b> Steel carrier rail; 35 x 7.5 mm; 1 mm thick; 2 m long; slotted; according to EN 60715; "Hole width 18 mm	<a href="http://www.wago.com/210-115">www.wago.com/210-115</a>
	<b>Item no.: 210-118</b> Steel carrier rail; 35 x 15 mm; 2.3 mm thick; 2 m long; unslotted; according to EN 60715	<a href="http://www.wago.com/210-118">www.wago.com/210-118</a>
	<b>Item no.: 210-196</b> Aluminum carrier rail; 35 x 8.2 mm; 1.6 mm thick; 2 m long; unslotted; similar to EN 60715; silver-colored	<a href="http://www.wago.com/210-196">www.wago.com/210-196</a>
	<b>Item no.: 210-197</b> Steel carrier rail; 35 x 15 mm; 1.5 mm thick; 2 m long; slotted; similar to EN 60715	<a href="http://www.wago.com/210-197">www.wago.com/210-197</a>







Subject to changes. Please also observe the further product documentation!

WAGO Kontakttechnik GmbH & Co. KG  
Hansastr. 27  
32423 Minden  
Phone: +49571 887-0 | Fax: +49571 887-169  
Email: [info.de@wago.com](mailto:info.de@wago.com) | Web: [www.wago.com](http://www.wago.com)





Do you have any questions about our products?  
We are always happy to take your call at +49 (571) 887-44222.

	<b>Item no.: 210-198</b> Copper carrier rail; 35 x 15 mm; 2.3 mm thick; 2 m long; unslotted; according to EN 60715; copper-colored	<a href="http://www.wago.com/210-198">www.wago.com/210-198</a>
	<b>Item no.: 210-504</b> Steel carrier rail; 35 x 7.5 mm; 1 mm thick; 2 m long; slotted; galvanized; according to EN 60715	<a href="http://www.wago.com/210-504">www.wago.com/210-504</a>
	<b>Item no.: 210-505</b> Steel carrier rail; 35 x 7.5 mm; 1 mm thick; 2 m long; unslotted; galvanized; according to EN 60715	<a href="http://www.wago.com/210-505">www.wago.com/210-505</a>
	<b>Item no.: 210-506</b> Steel carrier rail; 35 x 15 mm; 1.5 mm thick; 2 m long; unslotted; galvanized; similar to EN 60715	<a href="http://www.wago.com/210-506">www.wago.com/210-506</a>
	<b>Item no.: 210-508</b> Steel carrier rail; 35 x 15 mm; 1.5 mm thick; 2 m long; slotted; galvanized; similar to EN 60715	<a href="http://www.wago.com/210-508">www.wago.com/210-508</a>















shield connection

	<b>Item no.: 790-108</b> Shield clamping saddle; 11 mm wide; diameter of compatible conductor; 3 ... 8 mm	<a href="http://www.wago.com/790-108">www.wago.com/790-108</a>
	<b>Item no.: 790-116</b> Shield clamping saddle; 19 mm wide; diameter of compatible conductor; 7 ... 16 mm	<a href="http://www.wago.com/790-116">www.wago.com/790-116</a>
	<b>Item no.: 790-124</b> Shield clamping saddle; 27 mm wide; diameter of compatible conductor; 6 ... 24 mm	<a href="http://www.wago.com/790-124">www.wago.com/790-124</a>
	<b>Item no.: 790-140</b> Shield clamping saddle; diameter of compatible conductor	<a href="http://www.wago.com/790-140">www.wago.com/790-140</a>
	<b>Item no.: 790-208</b> Shield clamping saddle; 12.4 mm wide; 3 ... 8 mm	<a href="http://www.wago.com/790-208">www.wago.com/790-208</a>
	<b>Item no.: 790-216</b> Shield clamping saddle; 21.8 mm wide; 6 ... 16 mm	<a href="http://www.wago.com/790-216">www.wago.com/790-216</a>
	<b>Item no.: 790-220</b> Shield clamping saddle; 30 mm wide; 6 ... 20 mm	<a href="http://www.wago.com/790-220">www.wago.com/790-220</a>

Marking accessories

	<b>Item no.: 2009-145</b> Mini-WSB Inline; for Smart Printer; 1700 pieces on roll; stretchable 5 - 5.2 mm; plain; snap-on type; white	<a href="http://www.wago.com/2009-145">www.wago.com/2009-145</a>
	<b>Item no.: 2009-145/000-002</b> Mini-WSB Inline; for Smart Printer; 1700 pieces on roll; stretchable 5 - 5.2 mm; plain; snap-on type; yellow	<a href="http://www.wago.com/2009-145/000-002">www.wago.com/2009-145/000-002</a>
	<b>Item no.: 2009-145/000-005</b> Mini-WSB Inline; for Smart Printer; 1700 pieces on roll; stretchable 5 - 5.2 mm; plain; snap-on type; red	<a href="http://www.wago.com/2009-145/000-005">www.wago.com/2009-145/000-005</a>
	<b>Item no.: 2009-145/000-006</b> Mini-WSB Inline; for Smart Printer; 1700 pieces on roll; stretchable 5 - 5.2 mm; plain; snap-on type; blue	<a href="http://www.wago.com/2009-145/000-006">www.wago.com/2009-145/000-006</a>

Subject to changes. Please also observe the further product documentation!

	<p><b>Item no.: 2009-145/000-007</b>                  Mini-WSB Inline; for Smart Printer; 1700 pieces on roll; stretchable 5 - 5.2 mm; plain; snap-on type; gray</p>	<p><a href="http://www.wago.com/2009-145/000-007">www.wago.com/2009-145/000-007</a></p>
	<p><b>Item no.: 2009-145/000-012</b>                  Mini-WSB Inline; for Smart Printer; 1700 pieces on roll; stretchable 5 - 5.2 mm; plain; snap-on type; orange</p>	<p><a href="http://www.wago.com/2009-145/000-012">www.wago.com/2009-145/000-012</a></p>
	<p><b>Item no.: 2009-145/000-023</b>                  Mini-WSB Inline; for Smart Printer; 1700 pieces on roll; stretchable 5 - 5.2 mm; plain; snap-on type; green</p>	<p><a href="http://www.wago.com/2009-145/000-023">www.wago.com/2009-145/000-023</a></p>
	<p><b>Item no.: 2009-145/000-024</b>                  Mini-WSB Inline; for Smart Printer; 1700 pieces on roll; stretchable 5 - 5.2 mm; plain; snap-on type; violet</p>	<p><a href="http://www.wago.com/2009-145/000-024">www.wago.com/2009-145/000-024</a></p>
	<p><b>Item no.: 248-501</b>                  Miniature WSB Quick marking system; plain; Marker width 5 mm; 10 strips with 10 markers per card</p>	<p><a href="http://www.wago.com/248-501">www.wago.com/248-501</a></p>
	<p><b>Item no.: 248-501/000-002</b>                  Mini-WSB marking card; as card; not stretchable; plain; snap-on type; yellow</p>	<p><a href="http://www.wago.com/248-501/000-002">www.wago.com/248-501/000-002</a></p>
	<p><b>Item no.: 248-501/000-005</b>                  Mini-WSB marking card; as card; not stretchable; plain; snap-on type; red</p>	<p><a href="http://www.wago.com/248-501/000-005">www.wago.com/248-501/000-005</a></p>
	<p><b>Item no.: 248-501/000-006</b>                  Mini-WSB marking card; as card; not stretchable; plain; snap-on type; blue</p>	<p><a href="http://www.wago.com/248-501/000-006">www.wago.com/248-501/000-006</a></p>
	<p><b>Item no.: 248-501/000-007</b>                  Mini-WSB marking card; as card; not stretchable; plain; snap-on type; gray</p>	<p><a href="http://www.wago.com/248-501/000-007">www.wago.com/248-501/000-007</a></p>
	<p><b>Item no.: 248-501/000-012</b>                  Mini-WSB marking card; as card; not stretchable; plain; snap-on type; orange</p>	<p><a href="http://www.wago.com/248-501/000-012">www.wago.com/248-501/000-012</a></p>
	<p><b>Item no.: 248-501/000-017</b>                  Mini-WSB marking card; as card; not stretchable; plain; snap-on type; light green</p>	<p><a href="http://www.wago.com/248-501/000-017">www.wago.com/248-501/000-017</a></p>
	<p><b>Item no.: 248-501/000-023</b>                  Mini-WSB marking card; as card; not stretchable; plain; snap-on type; green</p>	<p><a href="http://www.wago.com/248-501/000-023">www.wago.com/248-501/000-023</a></p>
	<p><b>Item no.: 248-501/000-024</b>                  Mini-WSB marking card; as card; not stretchable; plain; snap-on type; violet</p>	<p><a href="http://www.wago.com/248-501/000-024">www.wago.com/248-501/000-024</a></p>
	<p><b>Item no.: 750-100</b>                  Marker card; as a DIN A4 sheet; plain; white</p>	<p><a href="http://www.wago.com/750-100">www.wago.com/750-100</a></p>

Subject to changes. Please also observe the further product documentation!





**Item no.: 750-103**  
Group marker carrier; transparent

[www.wago.com/750-103](http://www.wago.com/750-103)



**Item no.: 750-106**  
Group marker carrier; transparent

[www.wago.com/750-106](http://www.wago.com/750-106)

#### system box



**Item no.: 850-804**  
IP65 enclosure; Stainless steel; WxHxD (400x123x200 mm); 4 x M20, 16 x M16, 28 x M12 cable grip

[www.wago.com/850-804](http://www.wago.com/850-804)



**Item no.: 850-804/000-001**  
IP65 enclosure; Stainless steel; WxHxD (400x123x200 mm); 2 x M20, 13 x M16, 32 x M12 cable grip

[www.wago.com/850-804/000-001](http://www.wago.com/850-804/000-001)



**Item no.: 850-805**  
IP65 enclosure; Stainless steel; WxHxD (600x123x200 mm); 4 x M20, 19 x M16, 67 x M12 cable grip

[www.wago.com/850-805](http://www.wago.com/850-805)



**Item no.: 850-814/002-000**  
IP65 enclosure; Sheet steel (RAL 7035); WxHxD (200x120x200 mm); without flange plate

[www.wago.com/850-814/002-000](http://www.wago.com/850-814/002-000)



**Item no.: 850-815/002-000**  
IP65 enclosure; Sheet steel (RAL 7035); WxHxD (300x120x200 mm); without flange plate

[www.wago.com/850-815/002-000](http://www.wago.com/850-815/002-000)



**Item no.: 850-816/002-000**  
IP65 enclosure; Sheet steel (RAL 7035); WxHxD (400x120x200 mm); without flange plate

[www.wago.com/850-816/002-000](http://www.wago.com/850-816/002-000)



**Item no.: 850-817/002-000**  
IP65 enclosure; Sheet steel (RAL 7035); WxHxD (600x120x200 mm); without flange plate

[www.wago.com/850-817/002-000](http://www.wago.com/850-817/002-000)



**Item no.: 850-825**  
IP65 enclosure; Aluminium (RAL 7032); WxHxD (160x100x160 mm); 9 x M12, 4 x M20

[www.wago.com/850-825](http://www.wago.com/850-825)



**Item no.: 850-826**  
IP65 enclosure; Aluminium (RAL 7032); WxHxD (240x100x160 mm); 4 x M20, 4 x M16, 14 x M12 cable grip

[www.wago.com/850-826](http://www.wago.com/850-826)



**Item no.: 850-826/002-000**  
IP65 enclosure; Aluminium (RAL 7035); WxHxD (240x100x160 mm); 4 x M20, 4 x M16, 14 x M12 cable grip

[www.wago.com/850-826/002-000](http://www.wago.com/850-826/002-000)



**Item no.: 850-827**  
IP65 enclosure; Aluminium (RAL 7032); WxHxD (320x100x160 mm); 4 x M20, 8 x M16, 17 x M12 cable grip

[www.wago.com/850-827](http://www.wago.com/850-827)



**Item no.: 850-827/002-000**  
IP65 enclosure; Aluminium (RAL 7035); WxHxD (320x100x160 mm); 4 x M20, 8 x M16, 17 x M12 cable grip

[www.wago.com/850-827/002-000](http://www.wago.com/850-827/002-000)



**Item no.: 850-828**  
IP65 enclosure; Aluminium (RAL 7032); WxHxD (480x100x160 mm); 4 x M20, 10 x M16, 35 x M12 cable grip

[www.wago.com/850-828](http://www.wago.com/850-828)

Subject to changes. Please also observe the further product documentation!



**Item no.: 850-828/002-000**

IP65 enclosure; Aluminium (RAL 7035); WxHxD (480x100x160 mm); 4 x M20, 10 x M16, 35 x M12 cable grip

[www.wago.com/850-828/002-000](http://www.wago.com/850-828/002-000)



**Item no.: 850-834**

IP65 enclosure; Polyester (RAL 7032); WxHxD (164x100x164 mm); 9 x M12, 4 x M20

[www.wago.com/850-834](http://www.wago.com/850-834)



**Item no.: 850-835**

IP65 enclosure; Polyester (RAL 7032); WxHxD (244x100x164 mm); 4 x M20, 4 x M16, 14 x M12 cable grip

[www.wago.com/850-835](http://www.wago.com/850-835)



**Item no.: 850-836**

IP65 enclosure; Polyester (RAL 7032); WxHxD (324x100x164 mm); 4 x M20, 8 x M16, 17 x M12 cable grip

[www.wago.com/850-836](http://www.wago.com/850-836)

**Downloads**

**Documentation**

**Manual**

4-channel, ± 10VDC	V 1.1.0	pdf 1.9 MB	Download
--------------------	---------	---------------	----------

**Bid Text**

750-557 GAEB docx - Datei	Mar 5, 2019	docx 17.7 kB	Download
------------------------------	-------------	-----------------	----------

750-557 GAEB X81 - Datei	Feb 19, 2019	xml 4.5 kB	Download
-----------------------------	--------------	---------------	----------

**System Description**

Overview on WAGO-I/O-SYSTEM 750 approvals		pdf 780.2 kB	Download
---	--	-----------------	----------

Design Notes Basic conditions and recommendations for higher operational safety	V 2.0.0	pdf 1.5 MB	Download
--	---------	---------------	----------

750/753 Series I/O-System – General Product Information		pdf 1.7 MB	Download
---	--	---------------	----------

Use in Hazardous Environments Term definition, marking and installation regulations	V 1.0.0	pdf 1.0 MB	Download
--	---------	---------------	----------

Subject to changes. Please also observe the further product documentation!

WAGO Kontakttechnik GmbH & Co. KG  
 Hansastr. 27  
 32423 Minden  
 Phone: +49571 887-0 | Fax: +49571 887-169  
 Email: [info.de@wago.com](mailto:info.de@wago.com) | Web: [www.wago.com](http://www.wago.com)

Do you have any questions about our products?  
 We are always happy to take your call at +49 (571) 887-44222.



## CAD/CAE-Data

### CAD data

2D/3D Models 750-557	URL	Download
----------------------	-----	----------

### CAE data

EPLAN Data Portal 750-557	URL	Download
---------------------------	-----	----------

WSCAD Universe 750-557	URL	Download
------------------------	-----	----------

## Device Files

### Device Driver

WAGO USB Service Kabel Treiber / Serie 750 und 857	6.5.3.0 Sep 10, 2014	zip 4.8 MB	Download
--	-------------------------	---------------	----------

## Installation Notes

## Product family

**750/753 Series – I/O System**  
[Show all products from the family](#)

Subject to changes. Please also observe the further product documentation!

WAGO Kontakttechnik GmbH & Co. KG  
Hansastr. 27  
32423 Minden  
Phone: +49571 887-0 | Fax: +49571 887-169  
Email: [info.de@wago.com](mailto:info.de@wago.com) | Web: [www.wago.com](http://www.wago.com)

Do you have any questions about our products?  
We are always happy to take your call at +49 (571) 887-44222.