



MultiFiber™ Pro

Optical Power Meter and Fiber Test Kits

Users Manual

May 2012, Rev. 3 8/2015

©2012-2015 Fluke Corporation

All product names are trademarks of their respective companies.

LIMITED WARRANTY AND LIMITATION OF LIABILITY

Each Fluke Networks product is warranted to be free from defects in material and workmanship under normal use and service unless stated otherwise herein. The warranty period for the mainframe is one year and begins on the date of purchase. Parts, accessories, product repairs and services are warranted for 90 days, unless otherwise stated. Ni-Cad, Ni-MH and Li-Ion batteries, cables or other peripherals are all considered parts or accessories. The warranty extends only to the original buyer or end user customer of a Fluke Networks authorized reseller, and does not apply to any product which, in Fluke Networks' opinion, has been misused, abused, altered, neglected, contaminated, or damaged by accident or abnormal conditions of operation or handling. Fluke Networks warrants that software will operate substantially in accordance with its functional specifications for 90 days and that it has been properly recorded on non-defective media. Fluke Networks does not warrant that software will be error free or operate without interruption.

Fluke Networks authorized resellers shall extend this warranty on new and unused products to end-user customers only but have no authority to extend a greater or different warranty on behalf of Fluke Networks. Warranty support is available only if product is purchased through a Fluke Networks authorized sales outlet or Buyer has paid the applicable international price. To the extent permitted by law, Fluke Networks reserves the right to invoice Buyer for repair/replacement when a product purchased in one country is submitted for repair in another country.

For a list of authorized resellers, visit www.flukenetworks.com/wheretobuy.

Fluke Networks warranty obligation is limited, at Fluke Networks option, to refund of the purchase price, free of charge repair, or replacement of a defective product which is returned to a Fluke Networks authorized service center within the warranty period.

To obtain warranty service, contact your nearest Fluke Networks authorized service center to obtain return authorization information, then send the product to that service center, with a description of the difficulty, postage and insurance prepaid (FOB destination). Fluke Networks assumes no risk for damage in transit. Following warranty repair, the product will be returned to Buyer, transportation prepaid (FOB destination). If Fluke Networks determines that failure was caused by neglect, misuse, contamination, alteration, accident or abnormal condition of operation or handling, or normal wear and tear of mechanical components, Fluke Networks will provide an estimate of repair costs and obtain authorization before commencing the work. Following repair, the product will be returned to the Buyer transportation prepaid and the Buyer will be billed for the repair and return transportation charges (FOB Shipping point).

THIS WARRANTY IS BUYER'S SOLE AND EXCLUSIVE REMEDY AND IS IN LIEU OF ALL OTHER WARRANTIES, EXPRESS OR IMPLIED, INCLUDING BUT NOT LIMITED TO ANY IMPLIED WARRANTY OF MERCHANTABILITY OR FITNESS FOR A PARTICULAR PURPOSE. FLUKE NETWORKS SHALL NOT BE LIABLE FOR ANY SPECIAL, INDIRECT, INCIDENTAL OR CONSEQUENTIAL DAMAGES OR LOSSES, INCLUDING LOSS OF DATA, ARISING FROM ANY CAUSE OR THEORY.

Since some countries or states do not allow limitation of the term of an implied warranty, or exclusion or limitation of incidental or consequential damages, the limitations and exclusions of this warranty may not apply to every buyer. If any provision of this Warranty is held invalid or unenforceable by a court or other decision-maker of competent jurisdiction, such holding will not affect the validity or enforceability of any other provision.

Contents

Title	Page
Introduction	1
Registration	1
The Fluke Networks Knowledge Base	1
Contacting Fluke Networks	2
 Safety Information	2
Kit Contents	4
Battery Installation, Life, and Status	4
Keys and Connectors	5
Display Features	6
How to Change User Preferences	9
Polarity Detection	10
2 kHz Mode	10
Auto Wavelength Function	11
How to Clean MTP/MPO Connectors	11

MultiFiber Pro Optical Power Meter and Fiber Test Kits
Users Manual

How to Measure Optical Power	12
Power Measurements on 8- and 10-Fiber Cables	15
How to Measure Loss	16
Measure the Loss of Your Test Cords	16
Set the Limit for Loss Measurements	16
About the Reference	17
Set the Reference for Loss Measurements	17
Measure Loss	20
Loss Measurements on 8- and 10-Fiber Cables	23
If Loss is Negative	23
How to Identify Cables or Fibers	24
Memory Functions	25
View Records	25
Delete Records	26
Upload Records to a PC	28
Maintenance	29
Clean the Meter and Source	29
See the Software Version and Calibration Date	30
Update the Software	30
Options and Accessories	31

Specifications 32

 Environmental 32

 Meter 33

 Sources 35

 Calibration Cycle 36

 1 year 36

Appendix A: Polarities for MTP/MPO Connections 37

Appendix B: Reference and Test Connections 41

List of Figures

Figure		Page
1.	Installing the Batteries.....	4
2.	Meter and Source Features	5
3.	Meter Display Features	6
4.	Source Display Features	8
5.	How to Use the OneClick Cleaner for MTP/MPO Connectors	12
6.	Connections for Power Measurements.....	13
7.	Power Measurement Display.....	14
8.	Reference Connections for Multimode Permanent Links with Unpinned MTP/MPO Connectors	19
9.	Connections for Loss Measurements on Type A Multimode Permanent Links with Unpinned MTP/MPO Connectors	21
10.	Loss Measurement Display	22
11.	View Record Display (loss measurement shown)	27
12.	Connecting to a PC	29
A-1.	Connections for Types A, B, and C Patch Cords	38

Figure		Page
A-2.	Connections for the Corning Plug & Play™ Universal Systems Method.....	39
B-1.	Reference Connections for Multimode Permanent Links with Unpinned MTP/MPO Connectors	42
B-2.	Connections for Loss Measurements on Type A Multimode Permanent Links with Unpinned MTP/MPO Connectors	43
B-3.	Connections for Loss Measurements on Type B Multimode Permanent Links with Unpinned MTP/MPO Connectors	44
B-4.	Connections for Loss Measurements on Type C Multimode Permanent Links with Unpinned MTP/MPO Connectors	45
B-5.	Reference Connections for Multimode Permanent Links with Pinned and Unpinned MTP/MPO Connectors	46
B-6.	Connections for Loss Measurements on Type A Multimode Permanent Links with Unpinned and Pinned MTP/MPO Connectors	47
B-7.	Connections for Loss Measurements on Type B Multimode Permanent Links with Unpinned and Pinned MTP/MPO Connectors	48
B-8.	Connections for Loss Measurements on Type C Multimode Permanent Links with Unpinned and Pinned MTP/MPO Connectors	49
B-9.	Reference Connections for Multimode Permanent Links with Pinned MTP/MPO Connectors	50
B-10.	Connections for Loss Measurements on Type A Multimode Permanent Links with Pinned MTP/MPO Connectors	51
B-11.	Connections for Loss Measurements on Type B Multimode Permanent Links with Pinned MTP/MPO Connectors	52

Figure		Page
B-12.	Connections Loss Measurements on Type C Multimode Permanent Links with Pinned MTP/MPO Connectors.....	53
B-13.	Connections for Loss Measurements on Multimode Permanent Links with Pinned MTP/MPO Connectors when Links are Used with Corning Plug & Play™ Universal Systems.....	54
B-14.	Reference Connections for Multimode Fiber Modules with Pinned MTP/MPO Connectors	55
B-15.	Connections for Loss Measurements on a Straight-Through Multimode Fiber Module with a Pinned MTP/MPO Connector	56
B-16.	Connections for Loss Measurements on a Multimode Corning Plug & Play™ Universal Systems Module	57

MultiFiber™ Pro Fiber Test Kits

Introduction

The MultiFiber™ Pro meter and source let you measure optical power and power loss in fiber installations that have MTP®/MPO connectors.

In one test, the meter measures optical power or power loss on 12 fibers at one wavelength. The test results include the polarity of the connections (A, B, C, or other). The meter measures at 850 nm, 1300 nm, 1310 nm, or 1550 nm.

MultiFiber Pro sources supply optical power at 850 nm, 1310 nm, or 1550 nm.

The meter stores the loss or power measurements for up to 250 12-fiber cables. You can use LinkWare™ PC software to upload the records to a PC and create professional-quality test reports. You can download LinkWare PC from the Fluke Networks website.

Registration

Registering your product with Fluke Networks gives you access to valuable information on product updates, troubleshooting tips, and other support services. To register, go to the Fluke Networks website and click **Sign In**.

The Fluke Networks Knowledge Base

The Fluke Networks Knowledge Base answers common questions about Fluke Networks products and provides articles on cable testing techniques and technology. To access the Knowledge Base, log on to www.flukenetworks.com, then click **SUPPORT > Knowledge Base**.

Contacting Fluke Networks



 www.flukenetworks.com
 support@flukenetworks.com
 1-800-283-5853, +1-425-446-5500
 Fluke Networks
 PO Box 777
 Everett, WA 98206-0777
 USA

Fluke Networks operates in more than 50 countries worldwide. For more contact information, go to our website.

Safety Information

Table 1 describes the international electrical symbols used on the meter and source and in this manual.

Table 1. International Electrical Symbols

	Warning or Caution: risk of damage or destruction to equipment or software. See explanations in the manual.
	Warning: Risk of electric shock.

	Warning: Class 1 laser. Risk of eye damage from hazardous radiation.
	Do not put products containing circuit boards into the garbage. Dispose of circuits boards in accordance with local regulations.
	Conforms to requirements of European Union directives. Safety requirements for electrical equipment for measurement, control, and laboratory use.
 	Conforms to relevant Australian EMC standards
	Conforms to relevant North American safety standards. Listed by the Canadian Standards Association.

: This key on the meter and source turns the units on and off.

Warning

To prevent possible fire, electric shock, or personal injury:

- Read all safety information before you use the Product.

- Carefully read all instructions.
- Do not open the case. You cannot repair or replace parts in the case.
- Do not modify the Product.
- Use only replacement parts that are approved by Fluke Networks.
- Do not use the Product around explosive gas, vapor, or in damp or wet environments.
- Use this Product indoors only.
- Use the Product only as specified, or the protection supplied by the Product can be compromised.
- Do not use and disable the Product if it is damaged.
- Do not use the Product if it operates incorrectly.
- Batteries contain hazardous chemicals that can cause burns or explode. If exposure to chemicals occurs, clean with water and get medical aid.
- Remove the batteries if the Product is not used for an extended period of time, or if stored in temperatures above 50 °C. If the batteries are not removed, battery leakage can damage the Product.
- The battery door must be closed and locked before you operate the Product.
- Repair the Product before use if the battery leaks.

- Replace the batteries when the low battery indicator shows to prevent incorrect measurements.
- Be sure that the battery polarity is correct to prevent battery leakage.
- Do not disassemble or crush battery cells and battery packs.
- Do not put battery cells and battery packs near heat or fire. Do not put in sunlight.
- Have an approved technician repair the Product.

 **Warning: Class 1 Laser** 

To prevent possible eye damage caused by hazardous radiation:

- Do not look directly into optical connectors (see Figure 2). Some optical equipment emits invisible radiation that can cause permanent damage to your eyes.
- Do not turn on the source unless a fiber is attached to the port.
- When you inspect fiber endfaces, use only magnification devices that have the correct filters.
- Use of controls, adjustments, or procedures not stated herein can possibly result in hazardous radiation exposure.

Caution

To prevent damage to fiber connectors, to prevent data loss, and to ensure maximum accuracy of test results:

- Use proper cleaning procedures to clean all fiber connectors before every use. Neglecting this step or using improper procedures can cause unreliable test results and may permanently damage the connectors.
- Cover all connectors with protective caps when not in use.
- For correct measurements, connect only APC connectors to the singlemode sources. Connect only non-APC connectors to the multimode source. You can connect APC or non-APC connectors to the meter.
- For singlemode links with APC connectors, you must use Type A test cords and adapters. Type A components correctly align the angles in the connectors.
- Do not connect the source to an active network. Doing so can disrupt network operations.
- After you turn on the source, let it warm up for 10 minutes before use. Allow additional time if the source has been stored above or below ambient temperature.

Kit Contents

For a list of the contents of your MultiFiber Pro kit, see the list that came in the product's box or see the lists of models and accessories on the Fluke Networks website. If something is damaged or missing, contact the place of purchase immediately.

Battery Installation, Life, and Status

Figure 1 shows how to install the batteries. The batteries operate for 30 hours minimum in the meter and source. When the batteries are low, the low battery icon () flashes.

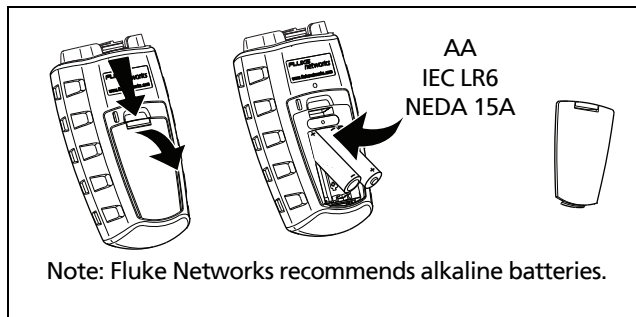

GUE02.EPS

Figure 1. Installing the Batteries

Keys and Connectors

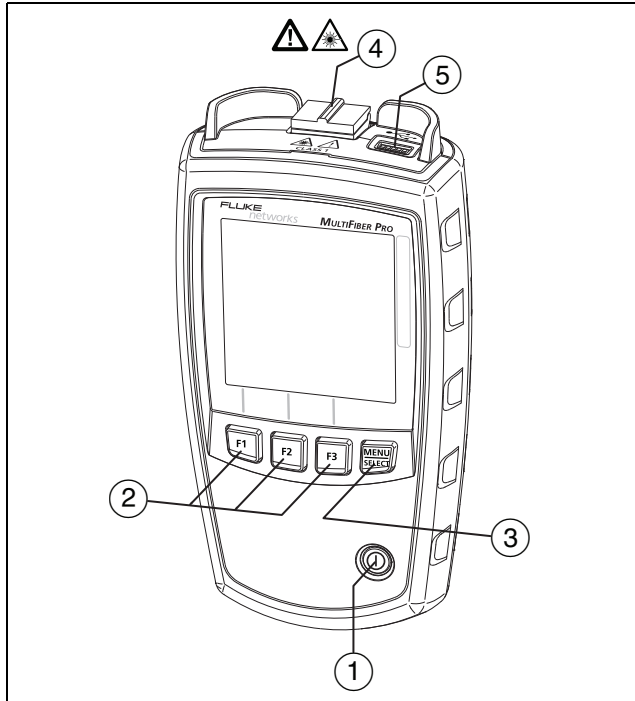

GUE05.EPS

Figure 2. Meter and Source Features

- ① : On/off key.
- ② : Softkeys. The function for each key shows above the key. For access to user preferences, hold down and for 2.5 seconds. See "How to Change User Preferences" on page 9.
- ③ : Meter: Press to change the measurement mode. For access to a menu of test settings and the **VIEW RECORD** mode, hold down for 2.5 seconds. See item ① in Figure 3 on page 6.

Source: To see modes for the source, hold down for 2.5 seconds. See item ① in Figure 4 on page 8.

- ④ MTP/MPO connector with self-closing, protective cover.

Caution

For correct measurements, connect only APC connectors to the singlemode sources. Connect only non-APC connectors to the multimode source. You can connect APC or non-APC connectors to the meter.

- ⑤ USB port for uploading test records from the meter to a PC. See "Upload Records to a PC" on page 28. You can also use the port to install software updates. See "Update the Software" on page 30.

Display Features

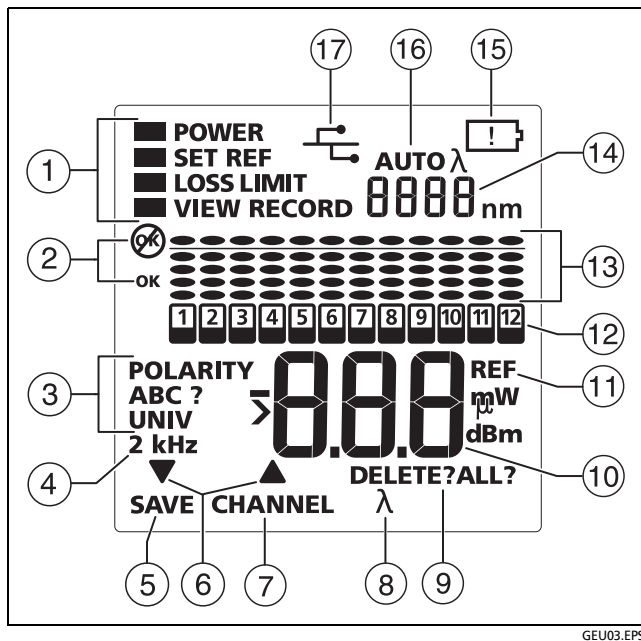

Figure 3. Meter Display Features



- 1 Modes for the meter and settings for tests.

To select the **POWER**, **SET REF**, or **LOSS** measurement modes, press . To change settings for measurements or to view records, hold down for 2.5 seconds, then use and and to make selections.

- **POWER**: Use this mode to measure optical power. See "How to Measure Optical Power" on page 12.
- **SET REF**: Use this mode to set the reference for loss measurements. See "Set the Reference for Loss Measurements" on page 17.
- **LOSS**: Use this mode to measure loss. See "How to Measure Loss" on page 16.
- **LOSS LIMIT**: Select this to set the limit for loss measurements. See "Set the Limit for Loss Measurements" on page 16.
- **VIEW RECORD**: Use this mode to see and delete saved results. See "View Records" on page 25.

- 2 : There is a problem with a measurement, or you tried to save a measurement, but the memory is full.

OK: All measurements are satisfactory, or the meter saved the results.

- ③ **POLARITY:** The polarity of the connections between the meter and source:
 - **A, B, C:** The connections use a standard method, A, B, or C. See Figure A-1 on page 38.
 - **POLARITY ?:** The connections do not use a standard method, one or more fibers are not connected, or **SCAN ALL** is off on the source.
 - **UNIV:** Shows when modules have the Corning Plug & Play™ Universal Systems method of polarity management. See Figure B-16 on page 57.
- ④ **2 kHz:** The meter detects a 2 kHz modulated optical signal. This function helps you identify fibers at patch panels. See "How to Identify Cables or Fibers" on page 24.
- ⑤ **SAVE:** When **SAVE** shows, you can press **F1** to save the power or loss measurement or the reference value.
- ⑥ **▼▲:** The arrow icons show when you can use **F1** ▼ or **F2** ▲ to scroll through selections or change settings.
- ⑦ **CHANNEL:** When you measure power or loss, press **F2** to scroll through the measurements for the channels.
- ⑧ **λ:** When the source is not in auto wavelength mode, press **F2** λ to change the wavelength.
- ⑨ **DELETE:** In **VIEW RECORD** mode, use **F3** **DELETE** to delete the selected record or all records. See "Delete Records" on page 26.
- ⑩ Numeric display with units for loss (**dB**) and power measurements (**mW, μW, dBm**).
- ⑪ **REF** (reference): Shows when you save the reference level. See "Set the Reference for Loss Measurements" on page 17.
- ⑫ : Channel indicator. When the source's **SCAN ALL** function is on, the channel indicator is on the channel that you select. When the source's **SCAN ALL** function is off, the indicator stays on the channel you select on the source. The numbers for the channels flash in sequence when the meter measures power or loss.
- ⑬ The bargraphs show relative value of the loss or power measurement for each channel. For power measurements, see Figure 7 on page 14. For loss measurements, see Figure 9 on page 21.
- ⑭ Numeric display for the wavelength.
- ⑮ : When the batteries are low, the low battery icon flashes.

- ⑩ **AUTO λ** shows when the source transmits a wavelength identifier, and the meter changes its wavelength setting to agree with the source. When only λ shows, you must press **[F3] λ** on the meter to select the correct wavelength. See page "Auto Wavelength Function" on page 11.
- ⑪ : This icon shows when the meter is connected to a PC through the USB port.

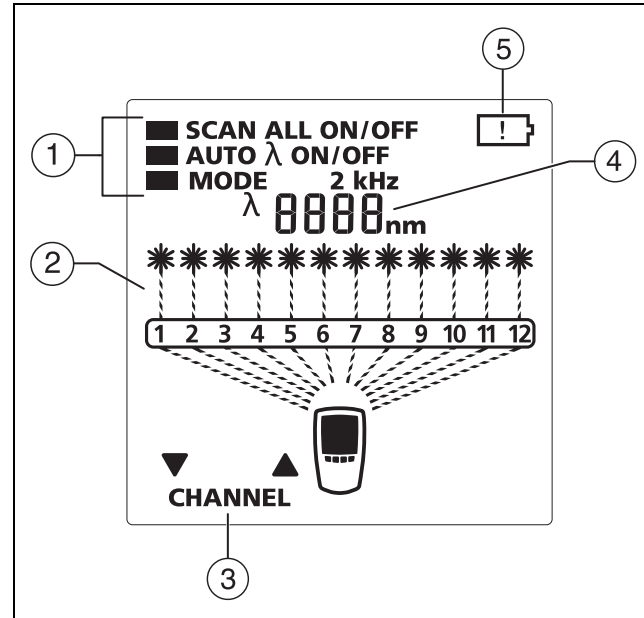







Figure 4. Source Display Features

GUE04.EPS

- ① Modes for the source (to see the menu, hold down  for 2.5 seconds):
 - **SCAN ALL ON:** The source changes the channel automatically.
 - **SCAN ALL OFF:** You press  ▼ or  ▲ to change the channel.
 - **AUTO λ : ON:** The source transmits a wavelength identifier that a MultiFiber Pro meter can read.
 - **AUTO λ : OFF:** The source does not transmit a wavelength identifier because the source is in **2 kHz** mode. See page "Auto Wavelength Function" on page 11.
 - **MODE 2 kHz:** The output is a 2 kHz modulated optical signal. Use this mode to identify fibers at patch panels. See "How to Identify Cables or Fibers" on page 24.
 - **SET λ :** Lets you change the wavelength when **AUTO λ** is **OFF**.
- ② Shows the channel that is active.
- ③ **CHANNEL:** When **SCAN ALL** is **OFF**, press  ▼ or  ▲ to change the channel.
- ④ Numeric display for the wavelength.

- ⑤ : When the batteries are low, the low battery icon flashes.

How to Change User Preferences

Table 2 describes the user preferences you can set for the meter and source.

To set user preferences for the meter or source







- 1 For the meter: Make sure the meter is in power or loss measurement mode.
For the source: Make sure the source is in signal output mode.
- 2 Hold down  and  together for 2.5 seconds.
- 3 To change a setting, press  ▲. Or press  if ▼ shows.
- 4 To see the next setting, press .
- 5 To save the settings and exit setup mode, hold down  and  for 2.5 seconds.

Table 2. User Preferences

Setting	Choices
oFF oñ	Turn the backlight off or on.
-- 10 20 30 60	The meter and source turn off automatically if you do not press any keys for the selected period of minutes. To disable this function, select the dashes.
ñt h dAY yr hr ñn	Meter only: Month (ñt h), day (dAY), year (yr), hour (hr), and minutes (ñn). The meter includes the date and time with measurements you save. The hour is in 24-hour format. To see the date and time in saved records, look at the records in LinkWare PC software.
SOF FAC	SOF: The software version number. FAC: Meter only. The factory calibration date. See "See the Software Version and Calibration Date" on page 30.

Polarity Detection





You can use the MultiFiber Pro meter and source to see the polarity of MTP/MPO patch cords and cables. The signals from the source include the channel numbers. The meter compares the transmitted numbers to the numbers of the channels that received the signals. The meter can then show the polarity of the connections:

- **A, B, C:** The connections use a standard method, A, B, or C. See Figure A-1 on page 38.
- **POLARITY ?:** The connections do not use a standard method, one or more fibers are not connected, or **SCAN ALL** is off on the source.
- **UNIV:** Shows when modules have the Corning Plug & Play™ Universal Systems method of polarity management. See Figure B-16 on page 57.

2 kHz Mode

The source has a 2 kHz modulated output mode that you can use to identify fibers. See "How to Identify Cables or Fibers" on page 24.

To select 2 kHz mode

- 1 On the source, hold down  for 2.5 seconds, press  ▼ or  ▲ to put the cursor next to **MODE**, then press  to make **2 kHz** show.
- 2 To save the setting and exit setup mode, hold down  for 2.5 seconds.

Notes

When the source is in 2 kHz mode and the meter is in loss measurement mode, , the bargraphs, **Err**, and **2 kHz** flash on the meter's display, and you cannot save measurements.

The source's auto wavelength function does not operate when you use **2 kHz** mode.

Auto Wavelength Function

The signal from the source includes an identifier that tells the meter which wavelength to measure. The source transmits the auto wavelength signal unless it is in **2 kHz** mode. When you select **2 kHz** mode, the source's **AUTO λ** setting automatically changes to **OFF**.

How to Clean MTP/MPO Connectors

Always clean and inspect endfaces in fiber connectors before you make connections. Fluke Networks recommends that you use a mechanical cleaner, such as the Fluke Networks IBC™ OneClick Cleaner, to clean connectors.

To use a OneClick cleaner to clean MTP/MPO connectors

Caution

To prevent damage to the device and to connectors and to keep contamination off of endfaces, read all instructions and obey all safety precautions given in the instructions for the device you use to clean connectors.

- 1 To clean a bulkhead connector, remove the cap from the cleaner. To clean the connector on a fiber cable, remove only the tip of the cap. See Figure 5.
- 2 Push the cleaner into the connector, then turn the dial on the cleaner until you hear a loud click. Then remove the cleaner.
- 3 Use a fiber microscope, such as the FT600 FiberInspector™ Mini Video Microscope, to inspect the connector. If necessary, clean and inspect the connector again.

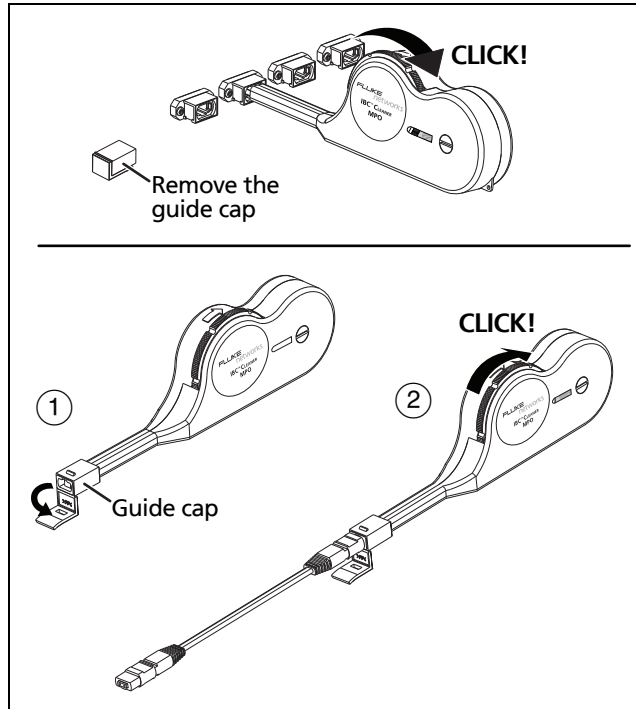

GUE01.EPS

Figure 5. How to Use the OneClick Cleaner for
MTP/MPO Connectors

How to Measure Optical Power

A power measurement shows the optical power level from a source such as an optical network interface card or optical test equipment.

The meter can show power measurements in watts or dBm.

To change the unit for power measurements

- 1 On the meter, hold down **MENU/SELECT** for 2.5 seconds to enter setup mode.
- 2 With the cursor next to **POWER**, press **MENU/SELECT**, then press **F1** ▼ or **F2** ▲ to select **W** (watts) or **dBm** (decibels relative to 1 milliwatt).
The meter automatically shows watts as milliwatts (**mW**) or microwatts (**μW**).
- 3 To save the setting and exit setup mode, press **MENU/SELECT**, then hold down **MENU/SELECT** for 2.5 seconds.

To measure power

- 1 Clean and inspect all connectors.
- 2 On the meter, press **MENU SELECT** to make **POWER** show.
- 3 Make the connections shown in Figure 6.
- 4 On the meter, press **F3** λ to select the wavelength of the source if necessary.
- 5 To see the power measurement for the next channel, press **F2** **CHANNEL**.

Notes

When you measure the power from a network interface card, the power level can change when the data rate changes.

2 kHz flashes and you cannot save measurements if the meter is connected to a MultiFiber Pro source that is set to 2 kHz mode.

- 6 To save the measurements, make sure the meter has done a scan through all 12 channels, then press **F1** **SAVE**. The meter briefly shows the record number and **OK**. The record number shown is for fiber number 12 in the cable.

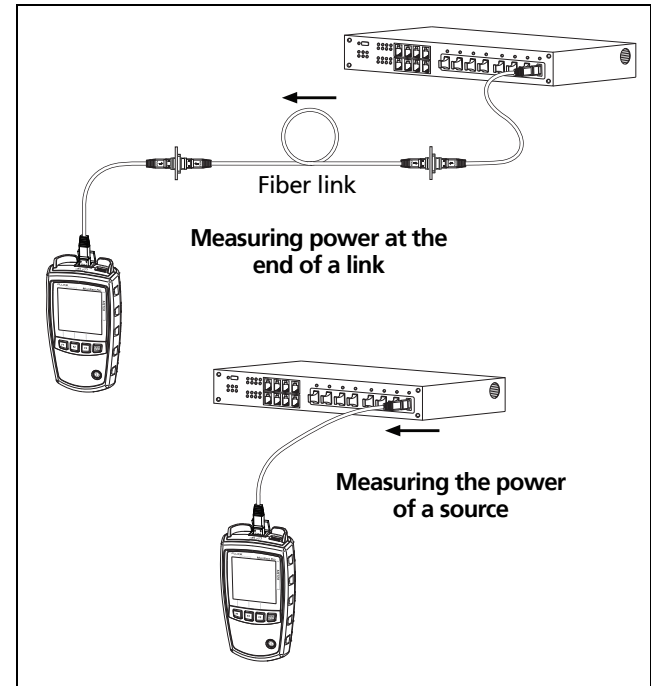

Figure 6. Connections for Power Measurements

GUE23.EPS

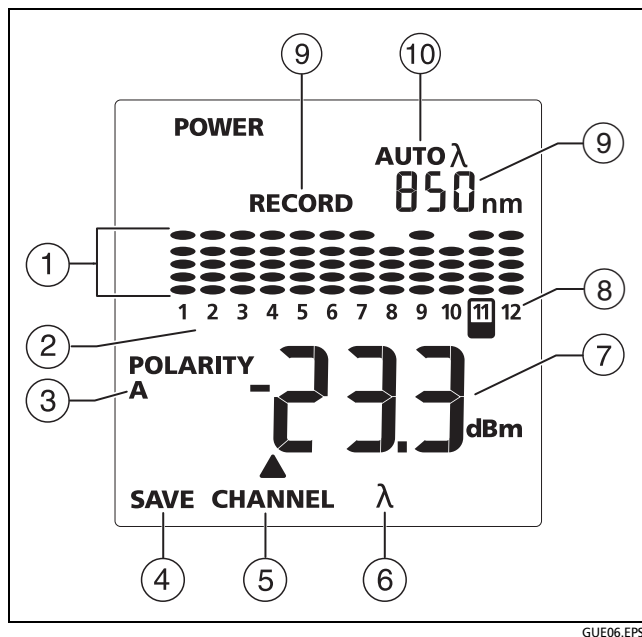
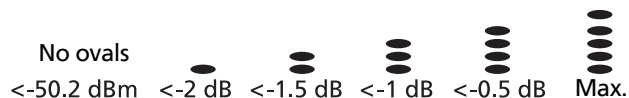

Figure 7. Power Measurement Display

- ① The difference (in dB) between the level of power on each channel and the maximum power of all 12 channels:



At regular intervals, the meter finds the maximum power level again and adjusts the bargraphs as necessary.

- ② The channel for the measurement shown (⑦). To change the channel, press **[F2]**.
- ③ **POLARITY**: The polarity of the connections between the meter and source:

Note

*The polarity indication shows on the meter only when the source's **SCAN ALL** function is on and all fibers are connected.*

- **A, B, C**: The connections use a standard method, A, B, or C. See Figure A-1 on page 38.
- **POLARITY ?**: The connections do not use a standard method, one or more fibers are not connected, or **SCAN ALL** is off on the source.

- **UNIV:** Shows when modules have the Corning Plug & Play™ Universal Systems method of polarity management. See Figure B-16 on page 57.

- ④ Press **F1** **SAVE** to save the measurements.

Note

SAVE does not show if the source is set to **2 kHz** mode.

- ⑤ **CHANNEL:** Press **F2** to see the measurement from the next channel.
- ⑥ **λ** shows when the source does not transmit a wavelength identifier. Press **F3** **λ** to see the measurements for another wavelength.
- ⑦ The power measurement in watts (**W**, **mW**, **μW**) or decibels (**dBm**). To change the unit, see "To change the unit for power measurements" on page 12.
- ⑧ The numbers for the channels flash in sequence when the meter measures power.
- ⑨ These sections switch between the wavelength that the meter measures (**nm** shows) and the record number for the next record you save (**RECORD** shows).

- ⑩ **AUTO λ** shows when the source transmits a wavelength identifier and the meter changes its wavelength setting to agree with the source. When only **λ** shows, you must press **F3** **λ** on the meter to select the correct wavelength. See page "Auto Wavelength Function" on page 11.

Power Measurements on 8- and 10-Fiber Cables

The meter lets you measure power on MTP/MPO cables made for 40G and 100G standards:

- On 40G cables, the four middle fibers are dark. On 100G cables, one fiber on each side of the connector is dark.
- The meter shows -99 dB and no ovals for the dark fibers.
- When the meter sees the 40G or 100G configuration, it saves power measurements for only the 8 or 10 other fibers.

How to Measure Loss

The loss measurement shows how much optical power is lost in the fiber and connectors of a link.



Measure the Loss of Your Test Cords

To make sure your loss measurements on fiber installations are reliable, you must use good test cords. To make sure the cords are good, measure and record their loss at regular intervals. Use the procedures given in the next sections to set the reference and measure loss, but connect the test cord where the figures show the fiber link.

Note











A cord that qualifies as a test reference cord usually has a mated loss of 0.1 dB or less, but for cords with MPO connectors this is not possible. A typical minimum loss of a high-quality cord with MPO connectors is 0.35 dB.

Set the Limit for Loss Measurements

The meter compares loss measurements to a limit to give a status of **OK** or  to the measurements. If a measurement for a channel exceeds the limit,  flashes, the bargraph for that channel flashes, and the bargraph shows an oval above the limit line on the display.

You can set the limit from 0.05 dB to 50.0 dB. The increments are 0.05 dB up to 10.0 dB and 0.1 dB up to 50.0 dB. The default is 1.5 dB.

To set the limit

- 1 On the meter, hold down  for 2.5 seconds to see the setup menu, press   to put the cursor next to **LOSS LIMIT**, then press  to put the meter in the loss limit mode. (see Figure 7 on page 14).
- 2 While **LOSS LIMIT** shows, press   or   to decrease or increase the limit value. To change the value quickly, hold down the key.
- 3 To save the setting and exit setup mode, press , then, hold down  for 2.5 seconds.

About the Reference

The reference is the baseline power level for loss measurements. Regular referencing helps account for minor variations in source power and connection integrity. Also, since the reference is the baseline for measurements, the losses of the test cords and adapters used for referencing are excluded from test results.

For the most accurate test results, you should set the reference at these times:



- At the beginning of each day.
- Anytime you reconnect a test cord to the source.
- Anytime you see a negative loss measurement.

Set the Reference for Loss Measurements

Caution

For correct measurements, connect only APC connectors to the singlemode sources. Connect only non-APC connectors to the multimode source.

For singlemode links with APC connectors, you must use Type A test cords and adapters. Type A components correctly align the angles in the connectors.

- 1 Clean the connectors on the meter, source, and a test cord.
- 2 Turn on the meter and source and let them warm up for 10 minutes. Allow more time if the equipment has been stored above or below ambient temperature.
- 3 Make connections to set the reference. Figure 8 on page 19 shows reference connections for links with unpinned connectors. Appendix B shows connections for links with other types of connectors and for fiber modules. On the source, hold down  for 2.5 seconds to see the setup menu, then select these settings:
 - **SCAN ALL: ON**
 - **MODE: 2 kHz** does not show
- 4 On the meter, press  to make **SET REF** show.
- 5 If necessary, press  **CHANNEL** to see the power measurement for each channel to make sure they are satisfactory.

(continued)

If a power level is lower than -27.5 dBm ($1.78 \mu\text{W}$) or if Err and  show, look for these problems:

- There is a bad connection, a dirty connector, or a damaged fiber or connector. Clean and inspect all connectors, then do the reference procedure again.
- An unpinned connector is used where a pinned connector is necessary.
- The source is in **2 kHz** mode. Turn off **2 kHz** mode, then do the reference procedure again. See page 11.
- The power measurement on a channel is different from the measurement on an adjacent channel by 3 dB or more. This usually shows that a connection is bad, a connector is dirty, or fiber or connector on the patch cord is bad. Clean and inspect all connectors, then do the reference procedure again.

- 6 To save the reference measurements, press  **SAVE**. The meter saves the measurements and the display briefly shows rEF , **OK** and **REF**. Then the meter goes into loss measurement mode.

If the display shows Err and , look for the problems given in step 5.

Caution

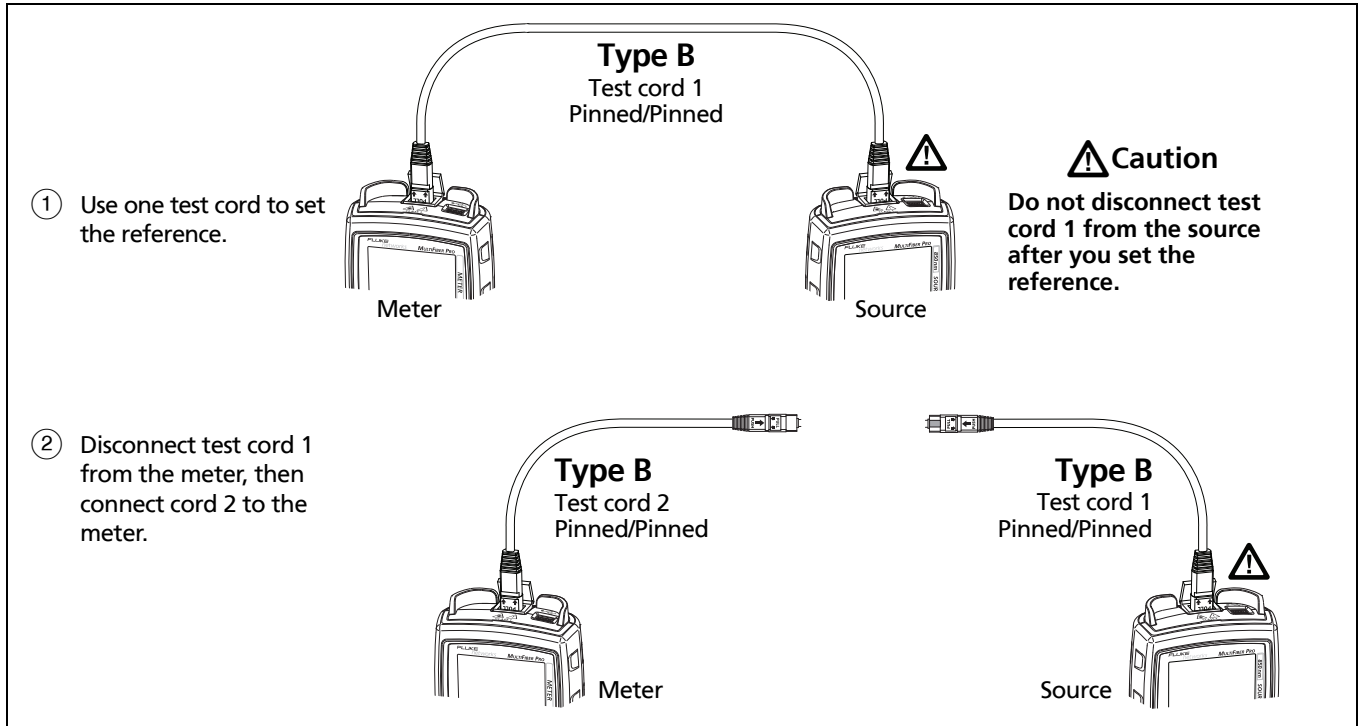

If you disconnect test cord 1 from the source after you set the reference, you must set the reference again to make sure the loss measurements are reliable.



GUE19.EPS

Figure 8. Reference Connections for Multimode Permanent Links with Unpinned MTP/MPO Connectors

Measure Loss

- 1 Set the reference as described on page 17.
- 2 Make sure the limit is correct. To see the limit, hold down  for 2.5 seconds, press  ▼ to put the cursor next to **LOSS LIMIT**, then press .
- 3 Clean and inspect the connectors on the link and on the required test cords.
- 4 Disconnect the test cord from the meter, then make the appropriate connections. Figure 9 on page 21 shows connections for a link with unpinned connectors. Appendix B shows connections for other types of links and connectors and for fiber modules.

Caution

Do not disconnect test cord 1 from the source. If you do, you must set the reference again to make sure the loss measurements are reliable.

For singlemode links with APC connectors, you must use Type A test cords and adapters. Type A components correctly align the angles in the connectors.

- 5 On the source, select these settings:
 - **SCAN ALL: ON**

- **MODE: 2 kHz** does not show
- 6 On the meter, press  to make **LOSS** show. Figure 10 on page 22 shows the display for loss measurements.

Notes

Err and  flash and you cannot save measurements if the wavelength setting on the meter is not the wavelength you used to set the reference.

2 kHz, **Err**, and  flash and you cannot save measurements if the source is set to **2 kHz** mode.

- 7 To save the measurements, make sure the meter has done a scan through all 12 channels, then press  **SAVE**. The meter briefly shows the record number and **OK**. The record number shown is for the number 12 fiber in the cable.

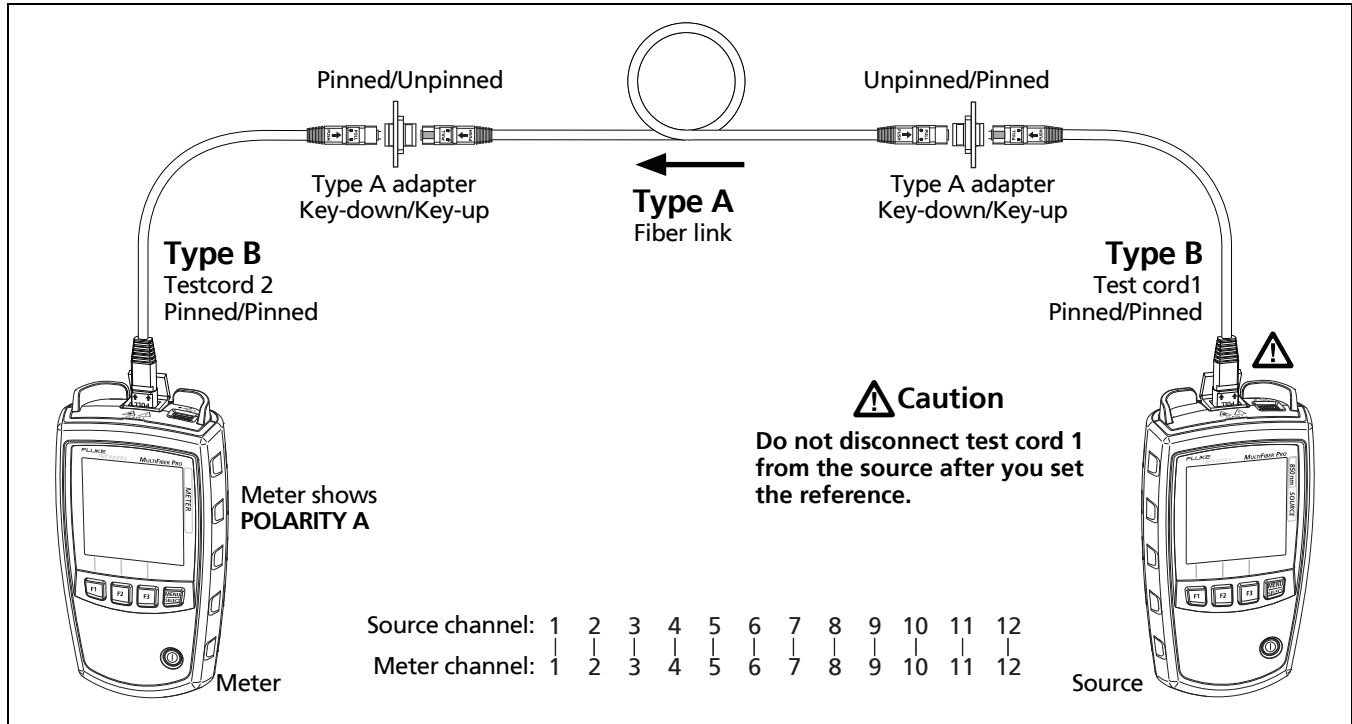

GUE10.EPS

Figure 9. Connections for Loss Measurements on Type A Multimode Permanent Links with Unpinned MTP/MPO Connectors

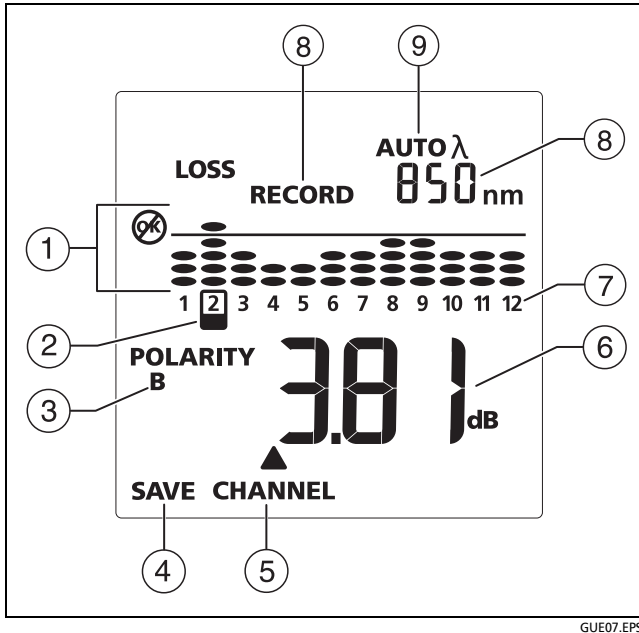
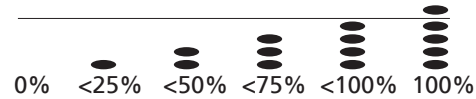

Figure 10. Loss Measurement Display

- ① The levels of power loss relative to the limit you set:



- When all ovals are below the line for a channel, the measurement for that channel is below the limit you set.
- If the loss for a channel exceeds the limit, the oval above the line is on and the bargraph for that channel flashes. flashes when the loss for any channel exceeds the limit.

- ② The channel for the measurement shown (⑦). To change the channel, press **F2** CHANNEL.
- ③ **POLARITY**: The polarity of the connections between the meter and source:

Note

*The polarity indication shows on the meter only when the source's **SCAN ALL** function is on and all fibers are connected.*

- **A, B, C**: The connections use a standard method, A, B, or C. See Figure A-1 on page 38.

- **POLARITY ?**: The connections do not use a standard method, one or more fibers are not connected, or **SCAN ALL** is off on the source.
- **UNIV**: Shows when modules have the Corning Plug & Play™ Universal Systems method of polarity management. See Figure B-16 on page 57.
-

- ④ Press **F1** **SAVE** to save the measurements.

Note

SAVE does not show if the source is set to **2 kHz** mode or if the wavelength setting on the meter is not the wavelength you used to set the reference.

- ⑤ **CHANNEL**: Press **F2** **CHANNEL** to see the measurement from the next channel.
- ⑥ The loss measurement in decibels (**dB**).

Note

If loss is negative, **OK** flashes and the meter shows the measurement for the channel that has the largest negative loss. See "If Loss is Negative" on page 23.

- ⑦ The numbers for the channels flash in sequence when the meter measures loss.

- ⑧ These sections switch between the wavelength that the meter measures (**nm** shows) and the record number for the next record you save (**RECORD** shows).
- ⑨ **AUTO λ** shows when the source transmits a wavelength identifier, and the meter changes its wavelength setting to agree with the source. See "Auto Wavelength Function" on page 11.

Loss Measurements on 8- and 10-Fiber Cables

The meter lets you set a reference and measure loss on MTP/MPO cables made for 40G and 100G standards:

- On 40G cables, the four middle fibers are dark. On 100G cables, one fiber on each side of the connector is dark.
- When the meter sees the 40G or 100G configuration, it does not show information for the dark fibers.
- The meter saves loss measurements for only the 8 or 10 other fibers.

If Loss is Negative

A negative loss measurement occurs when the measured power level is more than the reference power level. If the loss is negative by more than -0.09 dB, **OK** and the measurement flash on the meter.

Negative loss can be caused by the following:

- The fiber ends were dirty when you set the reference.
- The patch cord connected to the source was disconnected after you set the reference.
- There was a kink in a test cord when you set the reference.
- The connectors were not properly aligned when you set the reference.
- The meter and source were not set to the same wavelengths when you set the reference or measured loss.
- The meter or source was much colder when you set the reference.
- You did not allow enough time for the source to warm up before you set the reference.
- You measured loss on a fiber that is shorter than the test cord you used to set the reference.

If loss is negative, set the reference again then measure loss again.









How to Identify Cables or Fibers

You can use the 2 kHz modulated signal from the source to identify cables or fibers at patch panels. The meter shows **2 kHz** on the display when it detects the modulated signal.

To use the 2 kHz mode to identify cables or fibers

Caution

For correct measurements, connect only APC connectors to the singlemode sources. Connect only non-APC connectors to the multimode source.

- 1 Connect the source to the far end of the cabling.
- 2 On the source, hold down  until the setup menu shows. If **SCAN ALL** is **OFF**, press  to set it to **ON**.
Press   to put the cursor next to **MODE**, then press  to make **2 kHz** show.
- 3 On the meter, press  to put the meter in power measurement mode. You can also select loss measurement mode, but the display is easier to read in power measurement mode. If necessary, press   to set the meter to the same wavelength as the source.

Note

The source's auto wavelength function does not operate when you use 2 kHz mode.

To identify cables, use an MTP/MPO cable to connect the meter to cable outlets. To identify fibers, use a breakout cable to connect the meter to single or duplex fiber outlets.

- 4 When the meter receives the 2 kHz signal from the source, **2 kHz** shows on the meter.



If you use a breakout cable to connect the meter to an outlet, the channel indicator on the meter moves to the channel that is connected to the source. You can also turn off the **SCAN ALL** function on the source, then change the channel on the source to identify connections.

Memory Functions



The meter stores the loss or power measurements for up to 250 12-fiber cables. Each record contains the measurement for one fiber in a 12-fiber cable, for a maximum of 3000 records. For example, records 1 through 12 contain the measurements for the 12 fibers in one cable and records 13-24 contain the measurements for the 12 fibers in the next cable.





If memory is full, the meter shows  and **FULL** when you try to save measurements.

View Records

- 1 Hold down  for 2.5 seconds, press  to put the cursor next to **VIEW RECORD**, then press .

If no records are saved, dashes show for the record number and the measurement.

- 2 To scroll through the measurements for each fiber in a cable, press  ▼ or  ▲.

To scroll through the measurements for the same fiber number in each cable, press  ▼ or  ▲ to select a fiber, then hold down  ▼ or  ▲. In this mode, the record number increases or decreases by 12.

- 3 To exit the view record mode, press .

Note

Each record includes the date and time when the measurement was saved. To see the date and time, look at the records in LinkWare PC software.















Delete Records

You can delete one set of 12 records, or you can delete all the records in memory.









To delete one set of 12 records

Note

When you delete a set of 12 records, that set stays empty until you delete all records and save new ones.

- 1 Hold down  until the setup menu shows, press   to put the cursor next to **VIEW RECORD**, then press .
- 2 Use   or   to select the set of records to delete. See Figure 11 on page 27.
- 3 Press  **DELETE**. The display shows **DELETE?**.
To exit the delete mode and not delete the records, press , , or .
- 4 Hold down  **DELETE?** until **OK** shows. The 12 fibers show --- for their measurements, and no bargraphs show.
- 5 To exit the view record mode, press .

To delete all the records in memory

- 1 Hold down  until the setup menu shows, press  to put the cursor next to **VIEW RECORD**, then press .
- 2 Hold down  **DELETE** until the display shows **DELETE ALL?**, then release .
- To exit the delete mode and not delete the records, press , , or .
- 3 To delete all records, hold down  **DELETE ALL?**. As the meter deletes the records, the display shows the percentage of records deleted. At 100 percent, **OK** shows. Then the meter goes back to the power or loss measurement mode

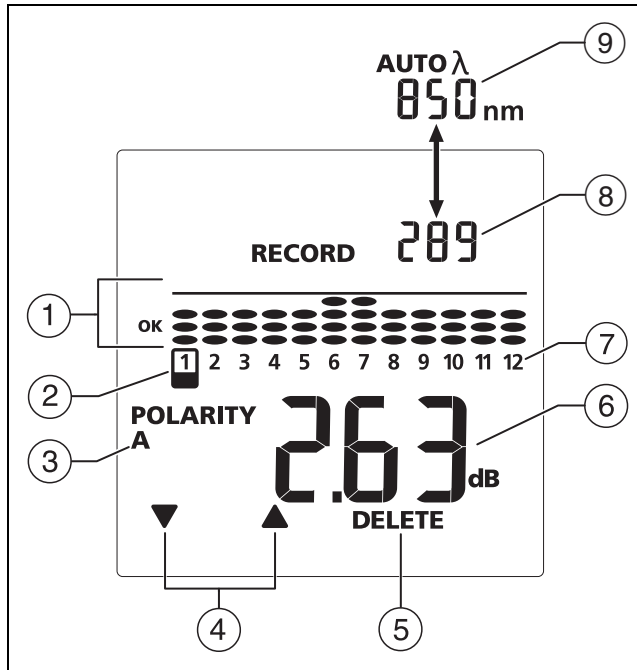

Figure 11. View Record Display
(loss measurement shown)

GUE00.EPS

- ① The relative level of power or power loss measured on the channel. For loss measurements, the limit line and **OK** or **∅** show. See Figure 7 on page 14 and Figure 10 on page 22 for descriptions of these measurements.
- ② The channel for the measurement shown (⑥). To change the channel, press **F1** ▼ or **F2** ▲ (④).
- ③ **POLARITY**: The polarity used for the connections between the meter and source.
- ④ To change the channel for the measurement shown (⑥), press **F1** ▼ or **F2** ▲.
- ⑤ Use **F3** **DELETE** to delete records. See "Delete Records" on page 26.
- ⑥ The measurement for the selected channel. To see the measurement for the next channel, press **F1** ▼ or **F2** ▲.
If the 12 records for a cable have been deleted, --- shows for each channel.
- ⑦ The fiber number.
- ⑧ The record number for the measurement shown.
- ⑨ The wavelength for the measurement. **AUTO λ** shows if the source was in auto wavelength mode during the measurement.

To use LinkWare PC software to delete all the records in memory

- 1 Install the latest version of LinkWare PC software on your PC. You can download LinkWare PC from the Fluke Networks website.
- 2 Turn on the meter.
- 3 Connect the meter to the PC with the USB cable provided, as shown in Figure 12.
- 4 Start LinkWare PC software on the PC.
- 5 On the LinkWare PC toolbar, select **Utilities > MultiFiber Pro > Delete All Tests in Memory**.

- 6 Enter project information, then click **OK**.
- 7 Import all records from the meter or select records to import.

Note

The record numbers from the meter are in the Cable ID column in LinkWare PC. LinkWare PC uses the cable number you entered as the first character in the IDs.

Upload Records to a PC

- 1 Install the latest version of LinkWare PC software on your PC. You can download LinkWare PC from the Fluke Networks website.
- 2 Turn on the meter.
- 3 Connect the meter to the PC with the USB cable provided, as shown in Figure 12.
- 4 Start LinkWare PC software on the PC.
- 5 Click **Import**  on the LinkWare PC tool bar, then select **MultiFiber Pro**.

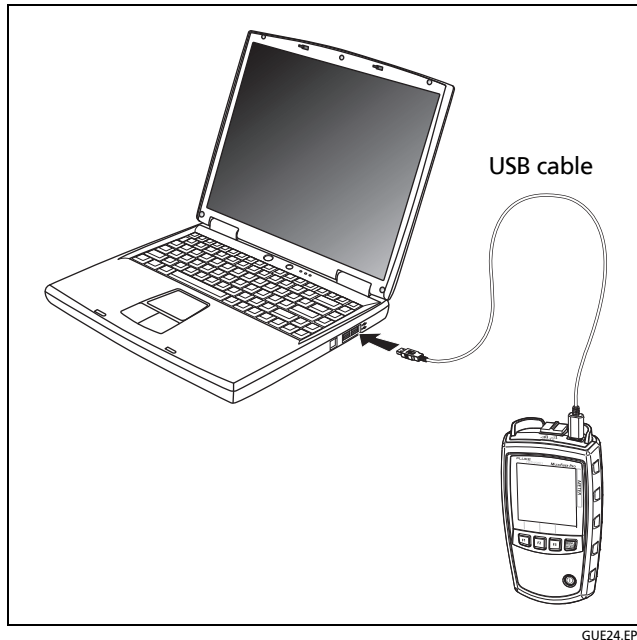

Figure 12. Connecting to a PC

Maintenance

⚠ Warning ⚠ ⚠

To avoid possible fire, electric shock, personal injury, or damage to the tester:

- Do not open the case. No user-serviceable parts are inside.
- Replacing electrical parts yourself will void the tester's warranty and might compromise its safety features.
- Use only specified replacement parts for user-replaceable items.
- Use only Fluke Networks authorized service centers.

Clean the Meter and Source

Clean the display with glass cleaner and a soft, lint-free cloth. Clean the case with a soft cloth dampened with water or water and a mild soap.

⚠ Caution

To prevent damage to the display or the case, do not use solvents or abrasive materials.

Clean the optical connector as described on page 11.

See the Software Version and Calibration Date

The displays can show the software versions for the meter and source and the calibration date for the meter. Calibration is not necessary for the source, so the source does not show a date.

To see the software version and calibration date

- 1 Turn on the meter or source, then hold down **F1** and **F3** together for 2.5 seconds.
- 2 Press **MENU SELECT** until the display shows **S □ F** then a number. The number is the software version
- 3 On the meter, press **MENU SELECT** again. The large characters shows **F A C** then one or two digits.

The large digits show the year of the last calibration. The four small digits show the day and month (DDMM) of the last calibration.

Update the Software

Caution

To prevent unexpected loss of power when you update the software, put new batteries in the meter and source if the low-battery icon shows (.

Note



The software update procedure does not delete the test records in the meter or the user preferences in the meter or source.

- 1 Install the latest version of LinkWare PC software on your PC. You can download LinkWare PC from the Fluke Networks website.
- 2 Download the MultiFiber Pro update file from the Fluke Networks website, or contact Fluke Networks to get the update by other methods. Save the file to your hard drive.

Note

The update file is in a zipped folder. You must extract the file before you can install the update in the meter or source.

- 3 Extract the update file (.mfp extension) from the zipped folder.

- 4 Connect the meter or source to the PC with the USB cable provided, as shown in Figure 12.
- 5 On the LinkWare PC menu, select **Utilities > MultiFiber Pro > Software Update**, find and select the update file, then click **Open**.
The meter or source display shows   during the installation process.
- 6 To make sure the update was installed correctly, look at the software versions on the meter and source. See "See the Software Version and Calibration Date" on page 30.

Options and Accessories

For a complete list of options and accessories visit the Fluke Networks website at www.flukenetworks.com.

Specifications

Environmental

Operating temperature	-10°C to +50°C
Storage temperature	-20°C to +50°C
Operating humidity	95% (10°C to +35°C) non-condensing 75% (35°C to +50°C) non-condensing Uncontrolled <10°C
Operating altitude	4,000 m
Storage altitude	12,000 m
Vibration	Random 2 G, 5 Hz to 500 Hz
Ingress protection rating	IEC 60529: IP40
Pollution degree	IEC 61010-1: Pollution degree 2, IEC 60825-1: Class 1
Electromagnetic environment	IEC 61326-1: Portable
Emissions classification	IEC CISPR 11: Group 1, Class A Group 1 have intentionally generated and/or use conductively coupled radio-frequency energy which is necessary for the internal functioning of the equipment itself. Class A equipment is suitable for use in non-domestic locations and/or directly connected to a low-voltage power supply network.

Meter

Specifications apply at 23°C (73°F), unless otherwise noted.

Detector type	InGaAs
Calibrated wavelengths	850 nm, 1300 nm, 1310 nm, 1550 nm
Measurement range	0 dBm to -50 dBm
Test time	6 seconds
Power measurement linearity	± 0.1 dB ^{1,2}
Power measurement uncertainty	± 0.35 dB ²
Power measurement repeatability	< 0.10 dB ²
Display resolution, dB or dBm	0.01 dB
Power display units	dBm, mW, μ W
User-selectable limit for loss	0.05 dB to 50.0 dB, in increments of 0.05 dB up to 10.0 dB and 0.1 dB up to 50.0 dB
Auto wavelength detection	Yes
Polarity detection	Detects A, B, C, and Corning Plug & Play™ Universal Systems polarities
<ol style="list-style-type: none"> For 850 nm, 0 dBm to -50 dBm. For 1300, 1310, 1550 nm, -5 to -50 dBm. For a continuous-wave optical signal. 	

Meter (continued)

2 kHz detection	Yes
Record storage	3000 records, one fiber per record (250 12-fiber cables)
External interface	USB 2.0, full speed
Optical connector	MTP/MPO interface for 12-fiber, unpinned plugs. Compatible with 62.5 μm , 50 μm , and singlemode fibers, PC or APC. Connector has a self-closing, protective cover.
Power requirement	2 AA alkaline batteries
Battery life³	>30 hours (typical)
Automatic power-off	10, 20, 30, or 60 minutes (can be disabled by the user)
Low battery warning	Low battery icon blinks
Size	5.8 in x 3.2 in x 1.6 in (14.7 cm x 8.0 cm x 4.0 cm)
Weight	10.9 oz (309 g)
3. Measured power levels ≤ 0 dBm. Backlight on. Battery life depends on the condition and type of batteries used. Fluke Networks recommends alkaline batteries.	

Sources

Specifications apply at 23°C (73°F), unless otherwise noted.

	850 nm Source	1310 nm Source	1550 nm Source
Emitter type	LED	Laser	
Wavelength	±30 nm	1310 nm ±20 nm	1550 nm ±20 nm
Spectral width (FWHM)	50 nm (typical)	2 nm typical, 5 nm maximum	
Minimum output power	≥ -24 dBm	≥ -1 dBm	
Power output stability	≤±0.1 dB over 8 hours ⁴	±0.25 dB over 8 hours ⁵	
Laser safety	IEC 60825-1:Class 1		
Encircled flux	Meets TIA 455-526-14B, ISO/IEC 14763-3, and IEC 61280-4-1 for 50/125 μm at the source's optical connector.	NA	
Optical connector	MTP/MPO interface for 12-fiber, unpinned plugs. Compatible with 62.5 μm and 50 μm fibers, non-APC only. Connector has a self-closing, protective cover.	MTP/MPO interface for 12-fiber, unpinned plugs. Compatible with 9 μm fibers, APC only. Connector has a self-closing, protective cover.	
<p>4. 23°C, after 10 minutes of warm-up time.</p> <p>5. 23°C, after 15 minutes of warm-up time.</p>			

Sources (continued)

	850 nm Source	1310 nm Source	1550 nm Source
Modes	2 kHz modulated, auto wavelength		
Power requirement	2 AA alkaline batteries		
Battery life⁶	>30 hours (typical)		
Automatic power-off	10, 20, 30, or 60 minutes (can be disabled by the user)		
Low battery warning	Low battery icon blinks		
Size	5.8 in x 3.2 in x 1.6 in (14.7 cm x 8.0 cm x 4.0 cm)		
Weight	11.4 oz (323 g)		
6. Auto wavelength, SCAN ALL , and backlight on. Battery life depends on the condition and type of batteries used. Fluke Networks recommends alkaline batteries.			

Calibration Cycle

1 year.

Appendix A: Polarities for MTP/MPO Connections

Figure A-1 on page 38 shows the end-to-end connections made by type A, B, and C cables with MTP/MPO connectors. The **POLARITY** indication on the meter shows **A, B, C** for these polarities.

The meter shows **UNIV** for the Corning Plug & Play™ Universal Systems method of polarity management. See Figure B-16 on page 57.

Note

*The polarity indication shows on the meter only when the source's **SCAN ALL** function is on and all fibers are connected.*

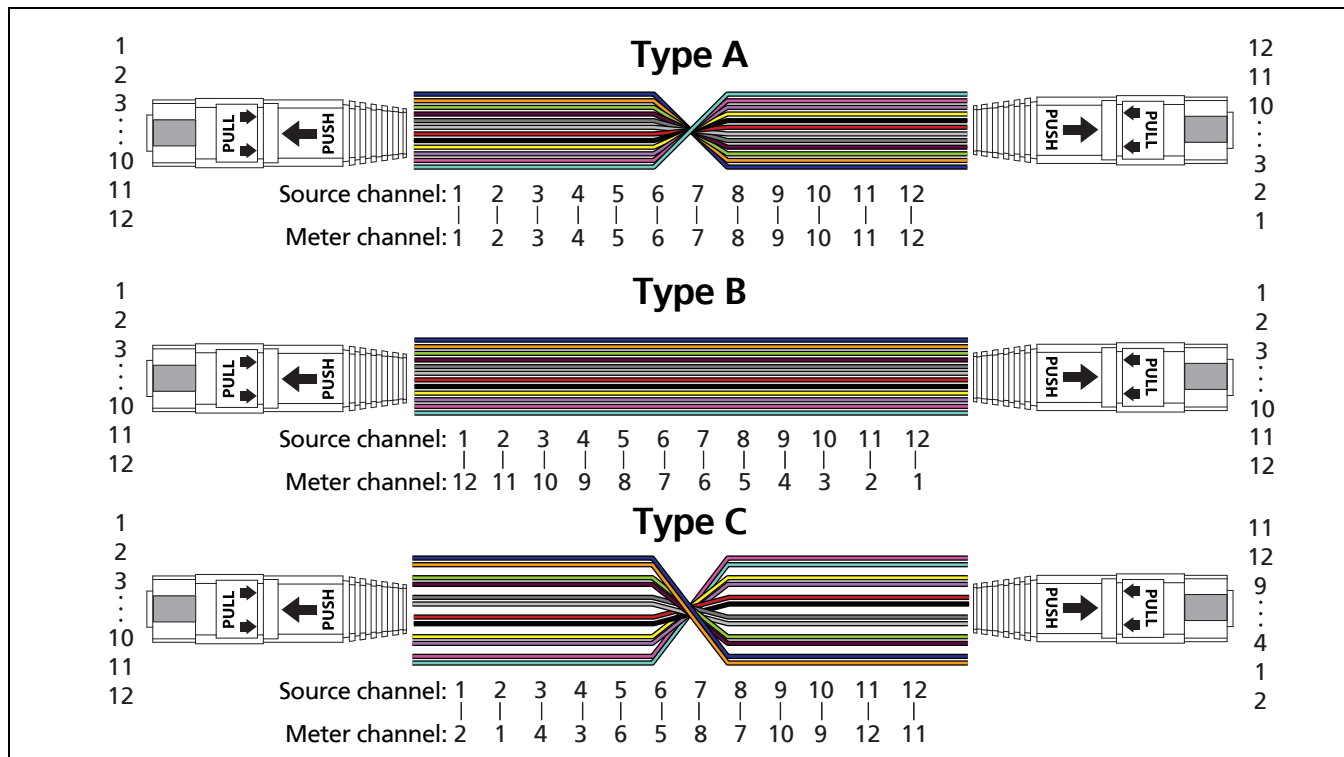

GUE08.EPS

Figure A-1. Connections for Types A, B, and C Patch Cords

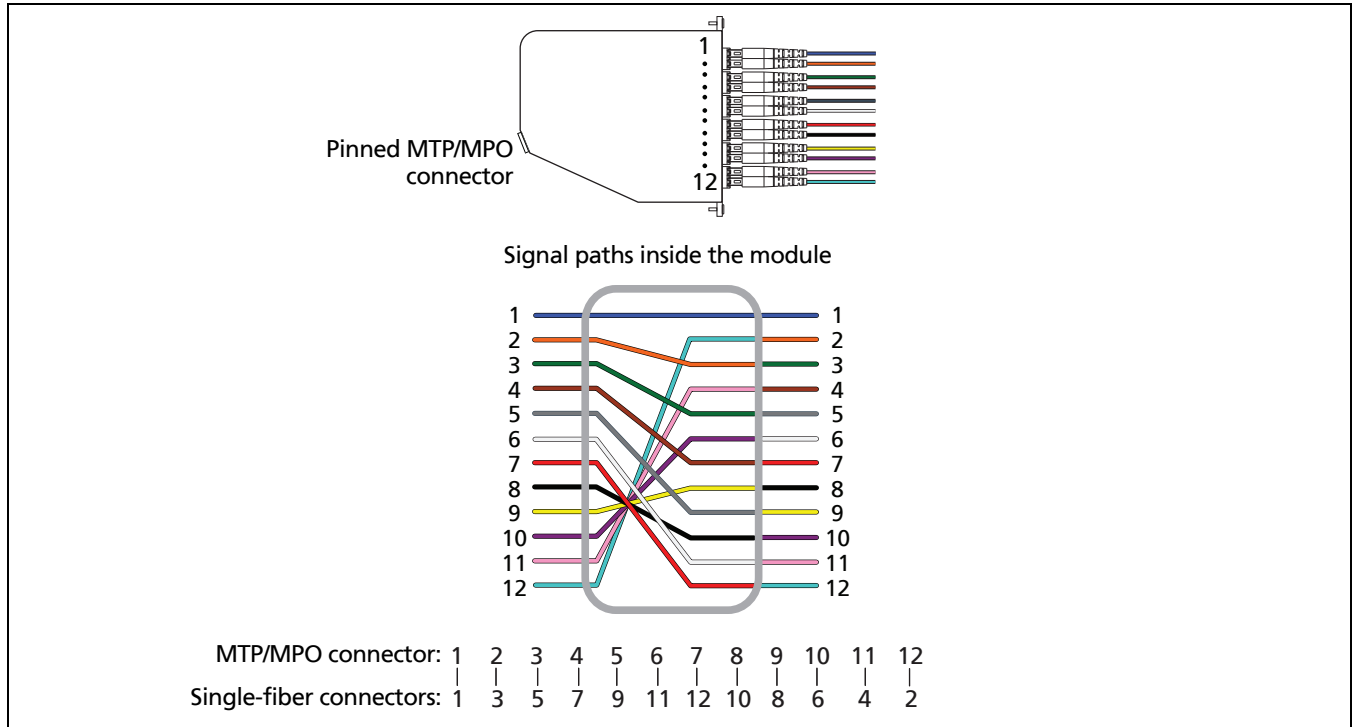

GUE28.EPS

Figure A-2. Connections for the Corning Plug & Play™ Universal Systems Method

Appendix B: Reference and Test Connections

This appendix shows the connections to make to set the reference and measure loss on MTP/MPO links with pinned and unpinned connectors.

Caution

For singlemode links with APC connectors, you must use Type A test cords and adapters. Type A components correctly align the angles in the connectors.

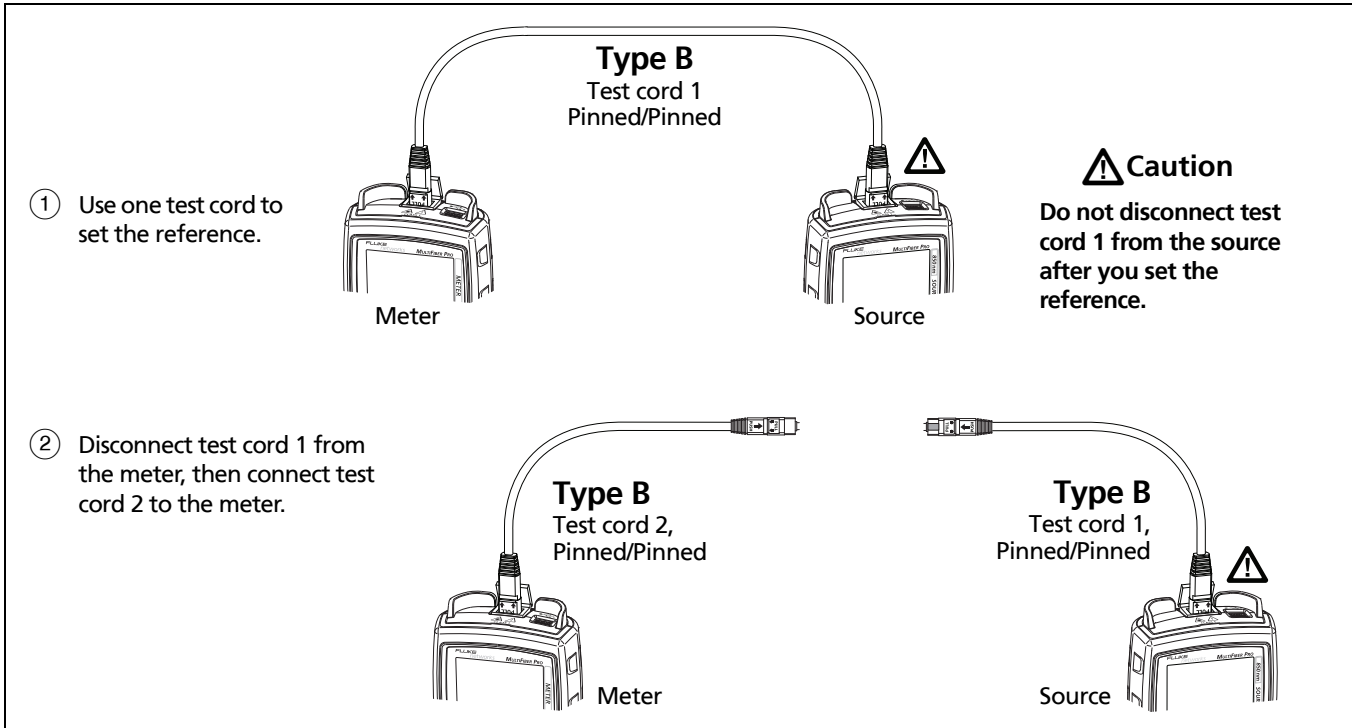

GUE19.EPS

Figure B-1. Reference Connections for Multimode Permanent Links with Unpinned MTP/MPO Connectors

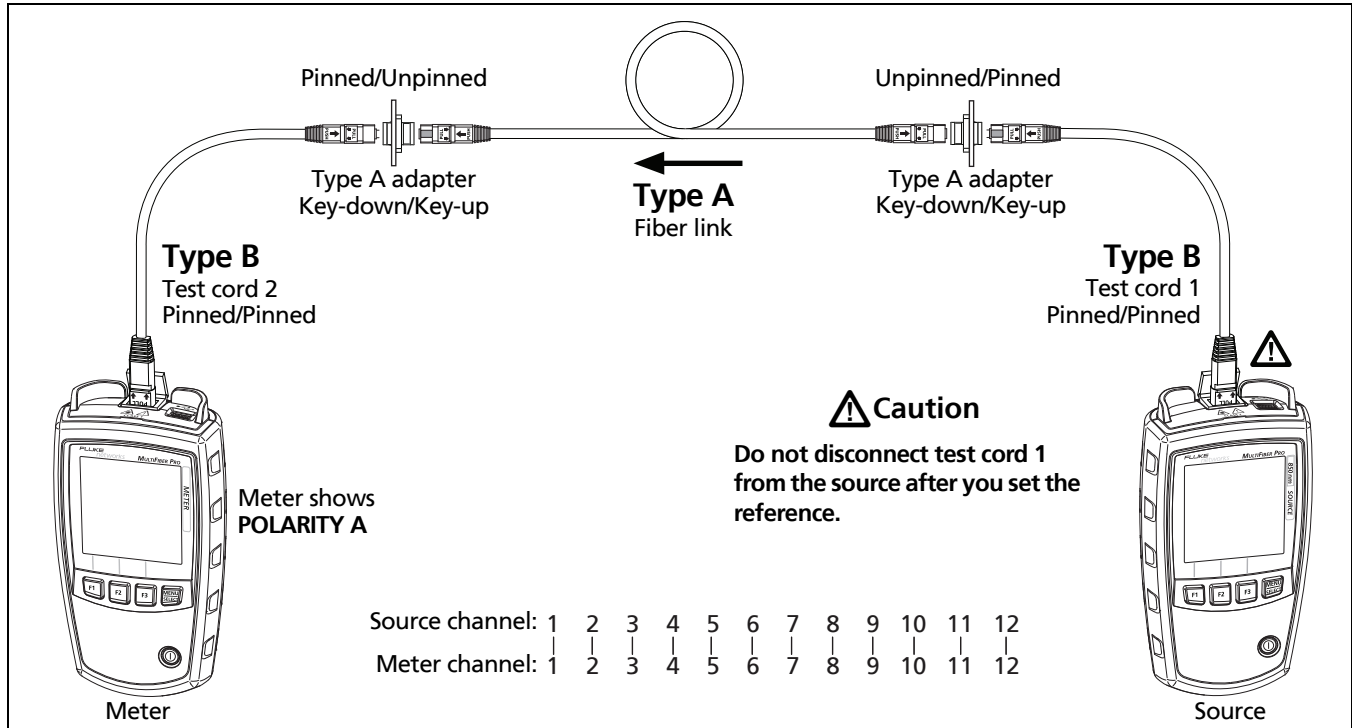

GUE10.EPS

Figure B-2. Connections for Loss Measurements on Type A Multimode Permanent Links with Unpinned MTP/MPO Connectors

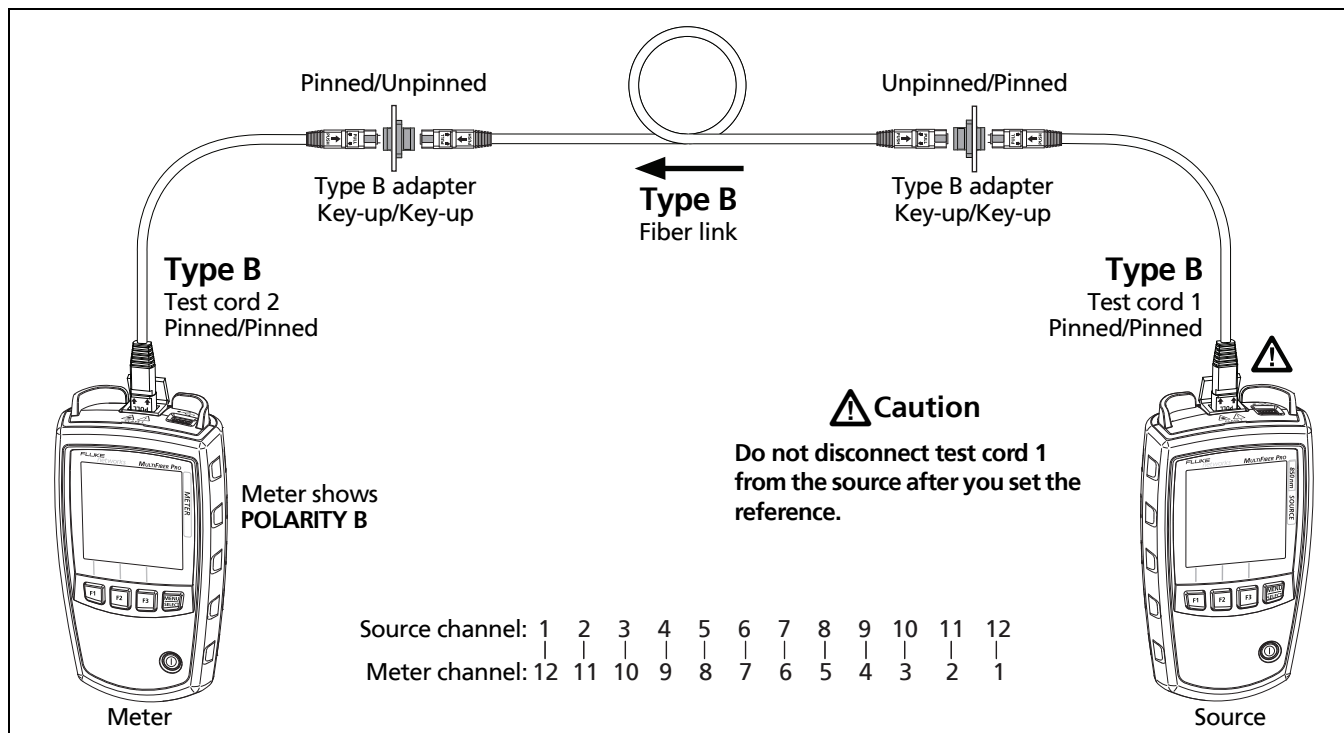

GUE12.EPS

Figure B-3. Connections for Loss Measurements on Type B Multimode Permanent Links with Unpinned MTP/MPO Connectors

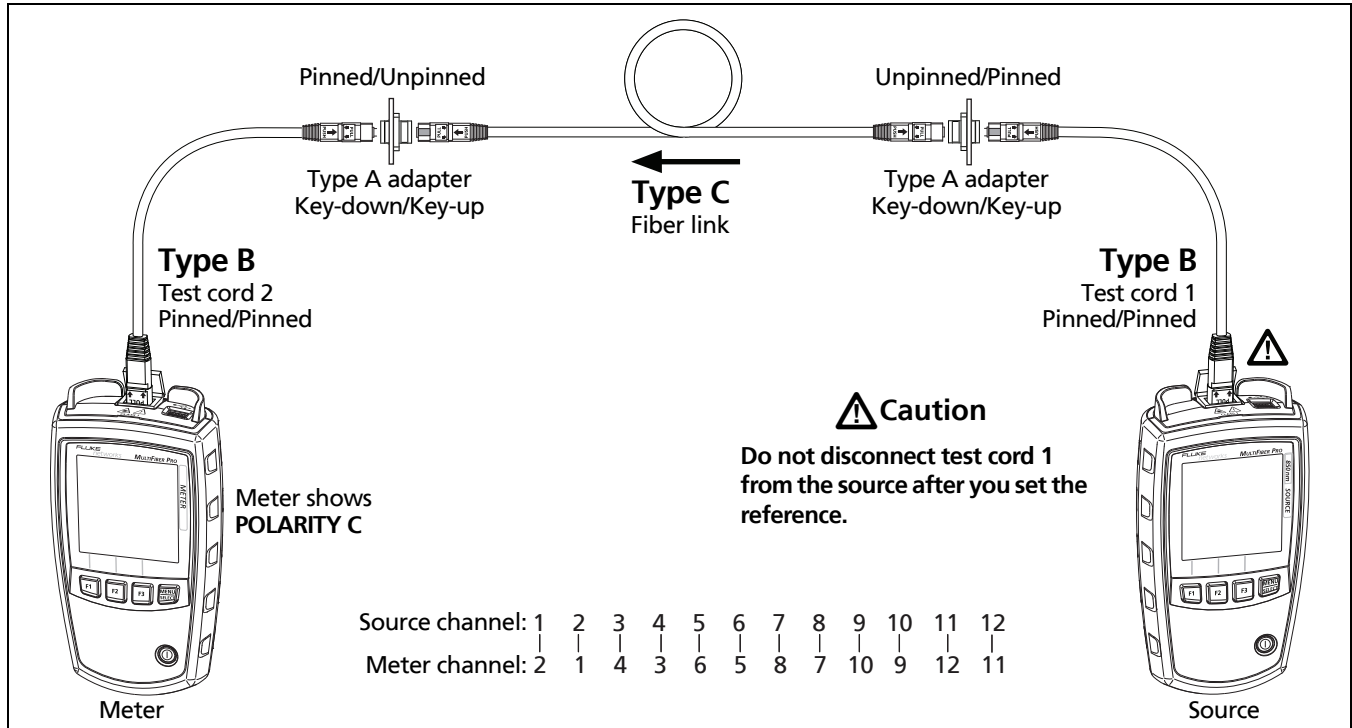

GUE20.EPS

Figure B-4. Connections for Loss Measurements on Type C Multimode Permanent Links with Unpinned MTP/MPO Connectors

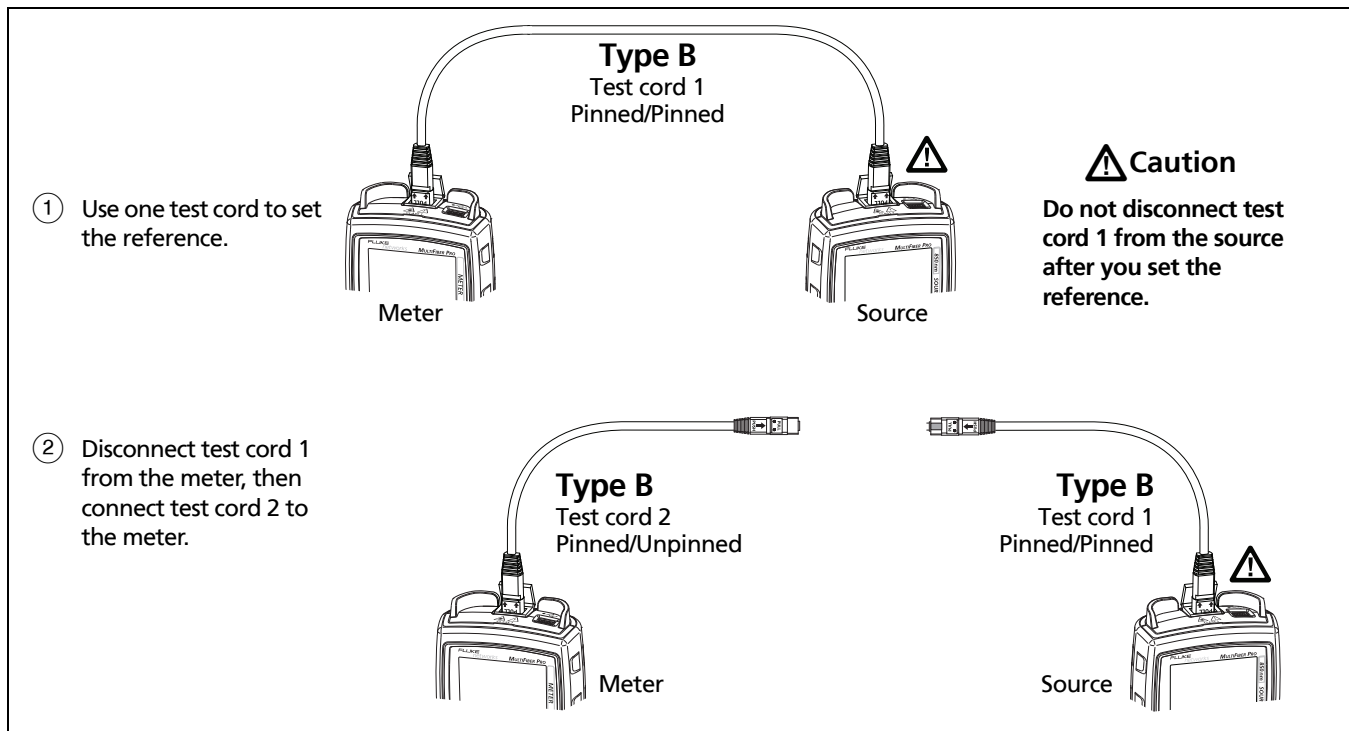

GUE26.EPS

Figure B-5. Reference Connections for Multimode Permanent Links with Pinned and Unpinned MTP/MPO Connectors

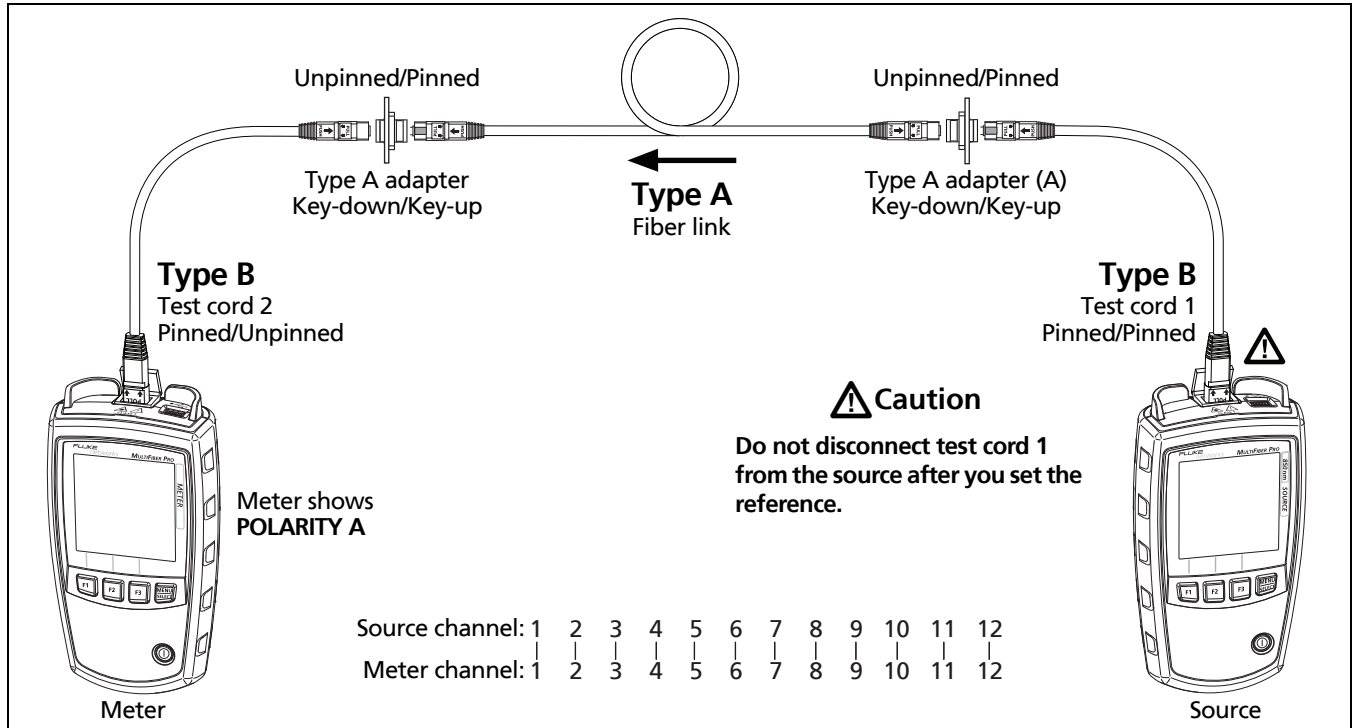

GUE11.EPS

Figure B-6. Connections for Loss Measurements on Type A Multimode Permanent Links with Unpinned and Pinned MTP/MPO Connectors

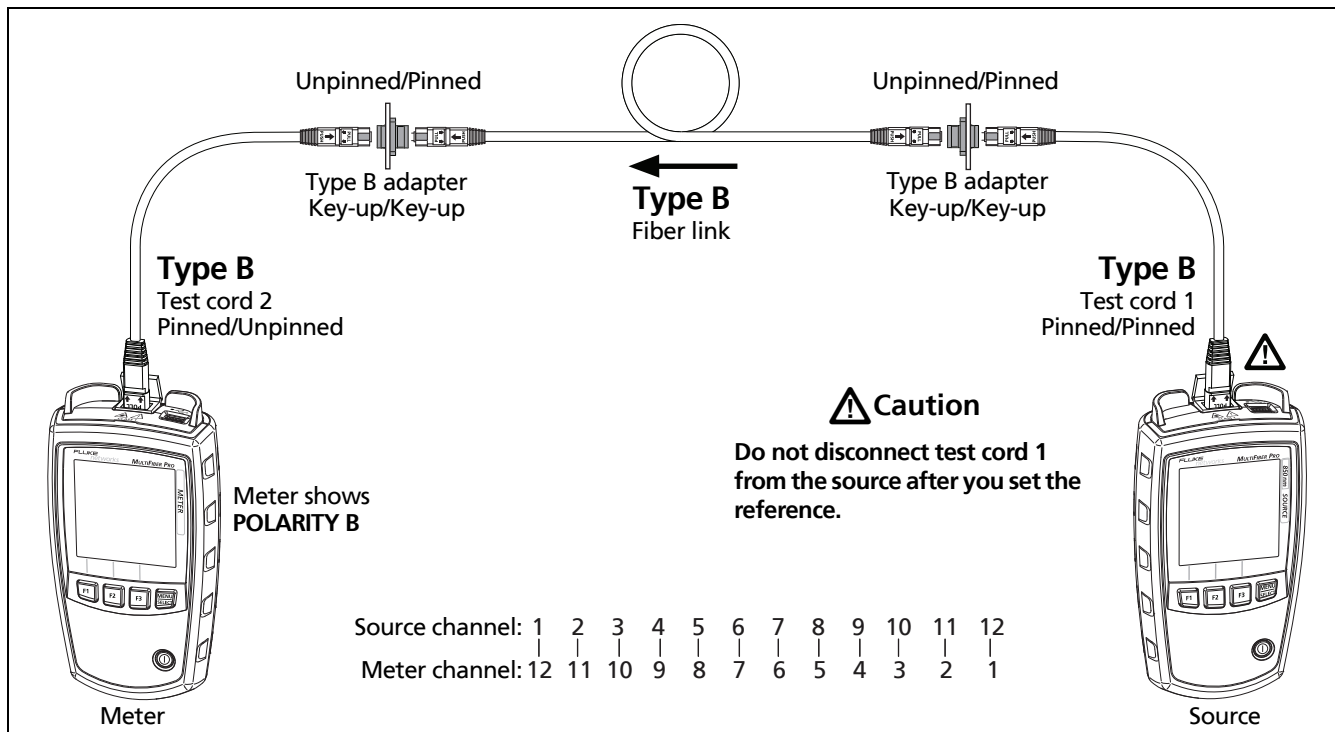

GUE25.EPS

Figure B-7. Connections for Loss Measurements on Type B Multimode Permanent Links with Unpinned and Pinned MTP/MPO Connectors

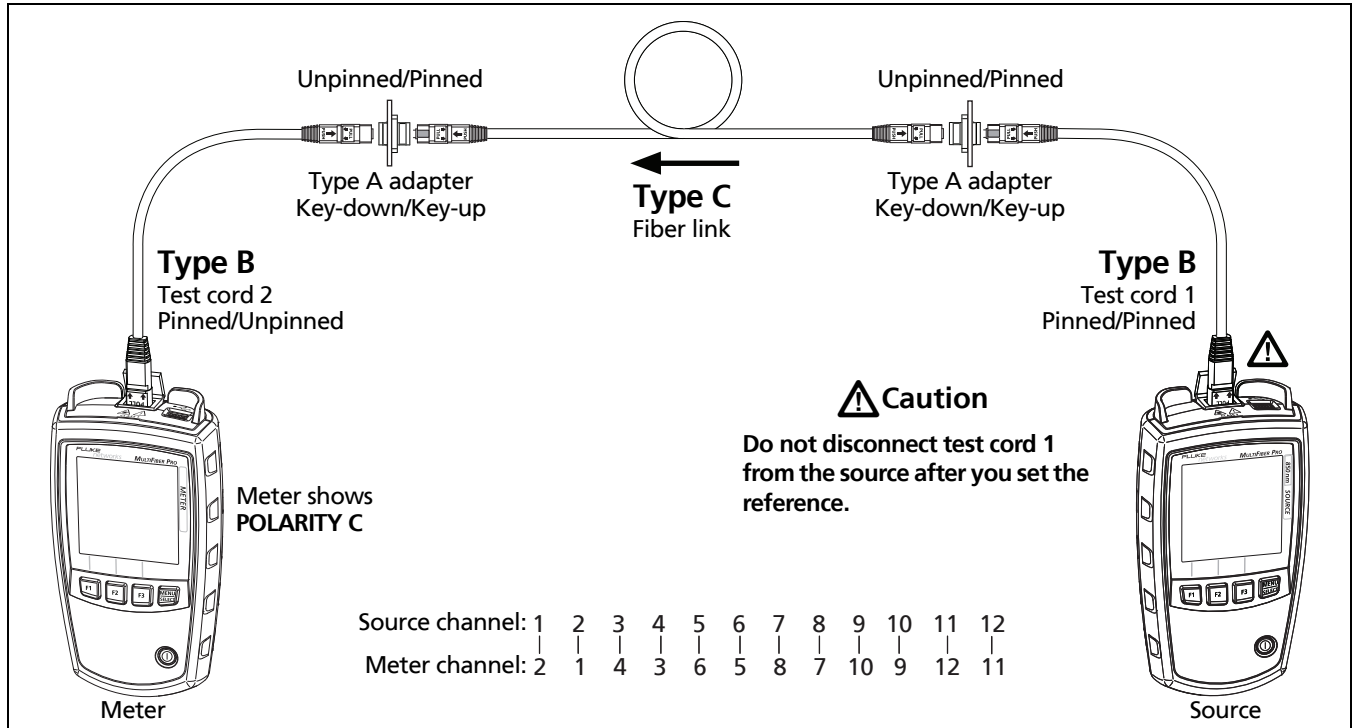
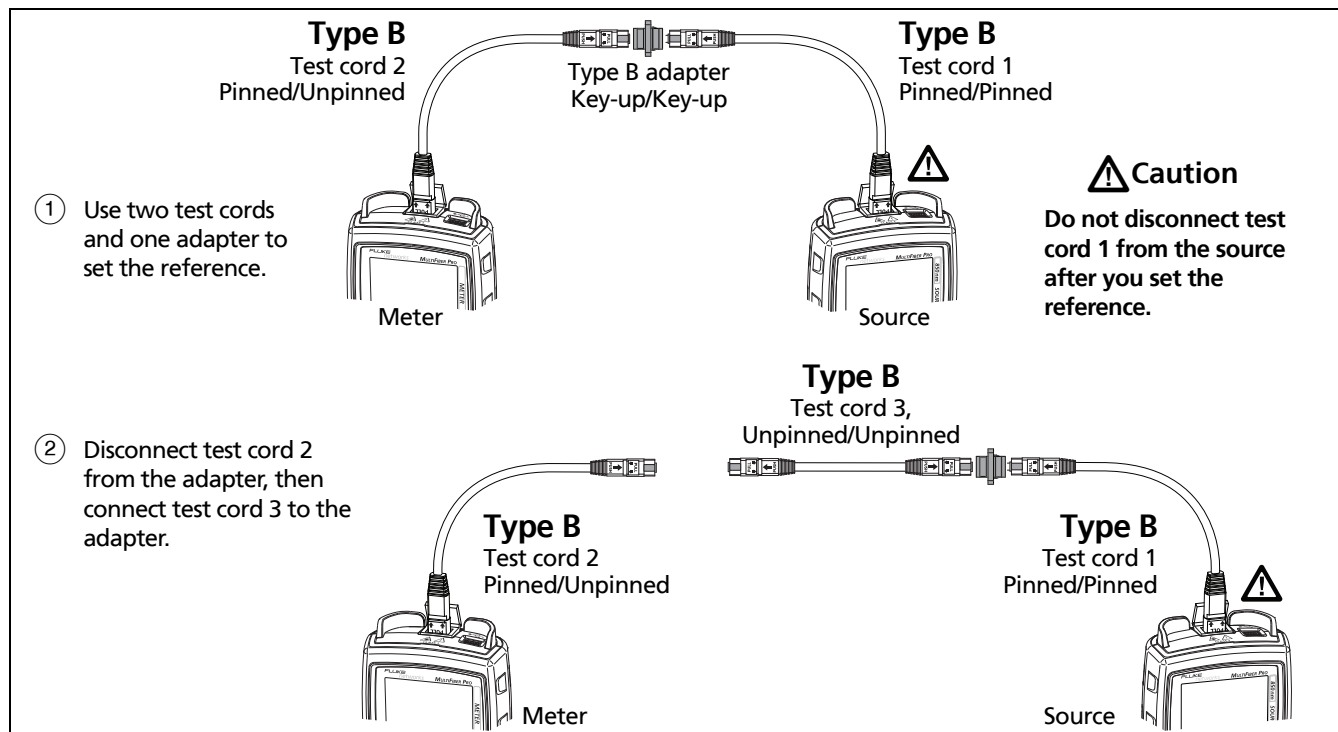

Figure B-8. Connections for Loss Measurements on Type C Multimode Permanent Links with Unpinned and Pinned MTP/MPO Connectors



GUE27.EPS

Figure B-9. Reference Connections for Multimode Permanent Links with Pinned MTP/MPO Connectors

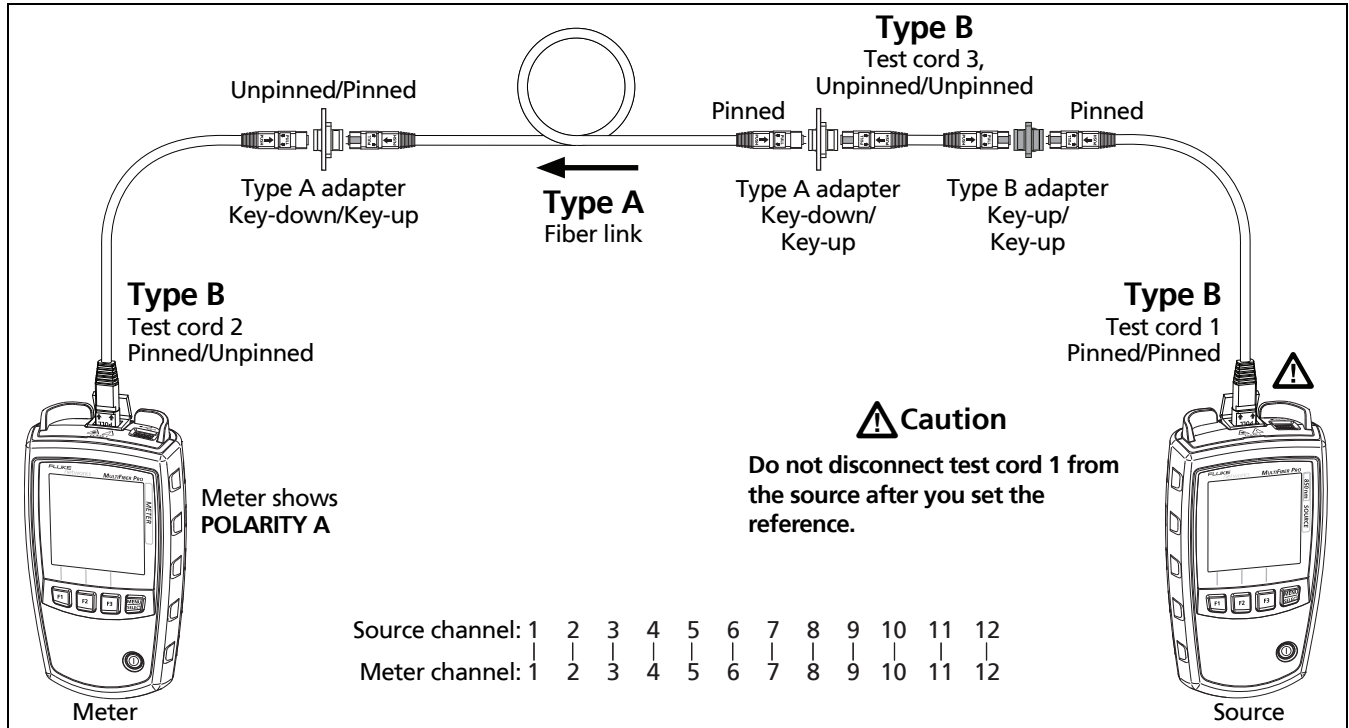
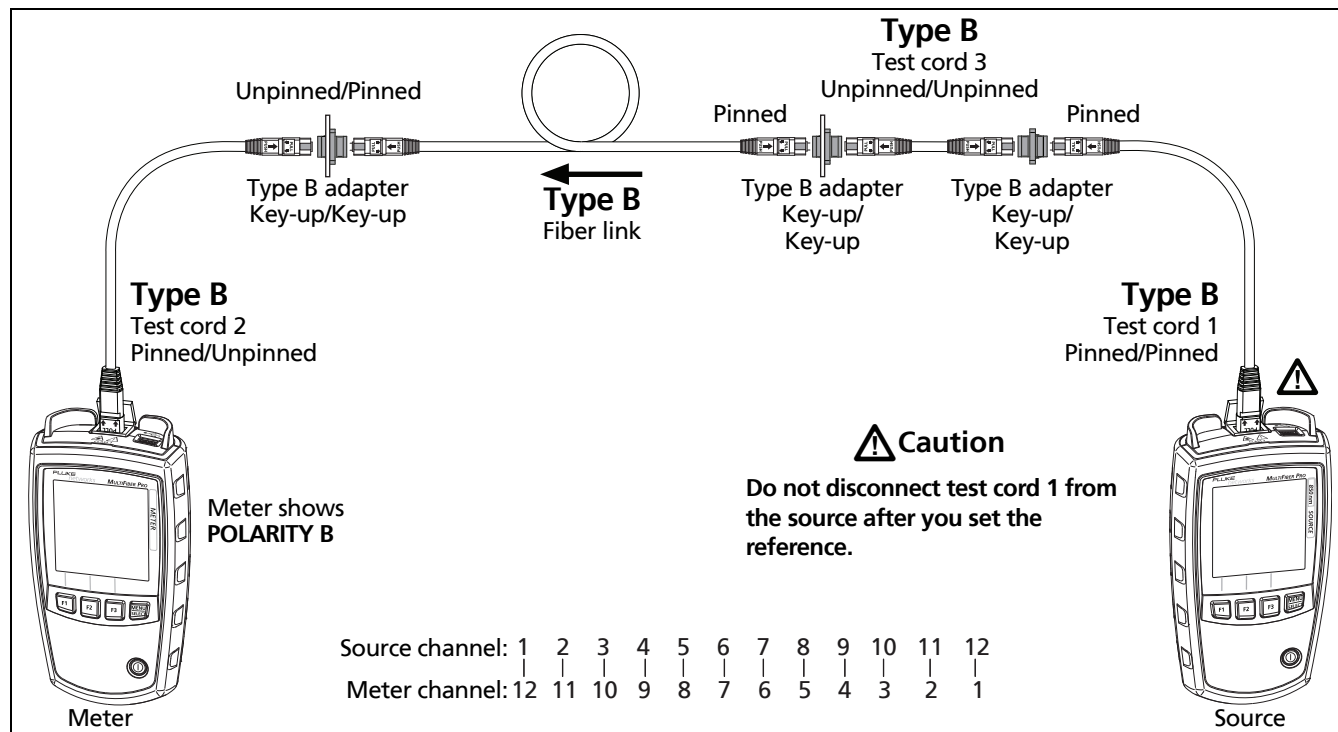

Figure B-10. Connections for Loss Measurements on Type A Multimode Permanent Links with Pinned MTP/MPO Connectors

GUE13.EPS



GUE14.EPS

Figure B-11. Connections for Loss Measurements on Type B Multimode Permanent Links with Pinned MTP/MPO Connectors

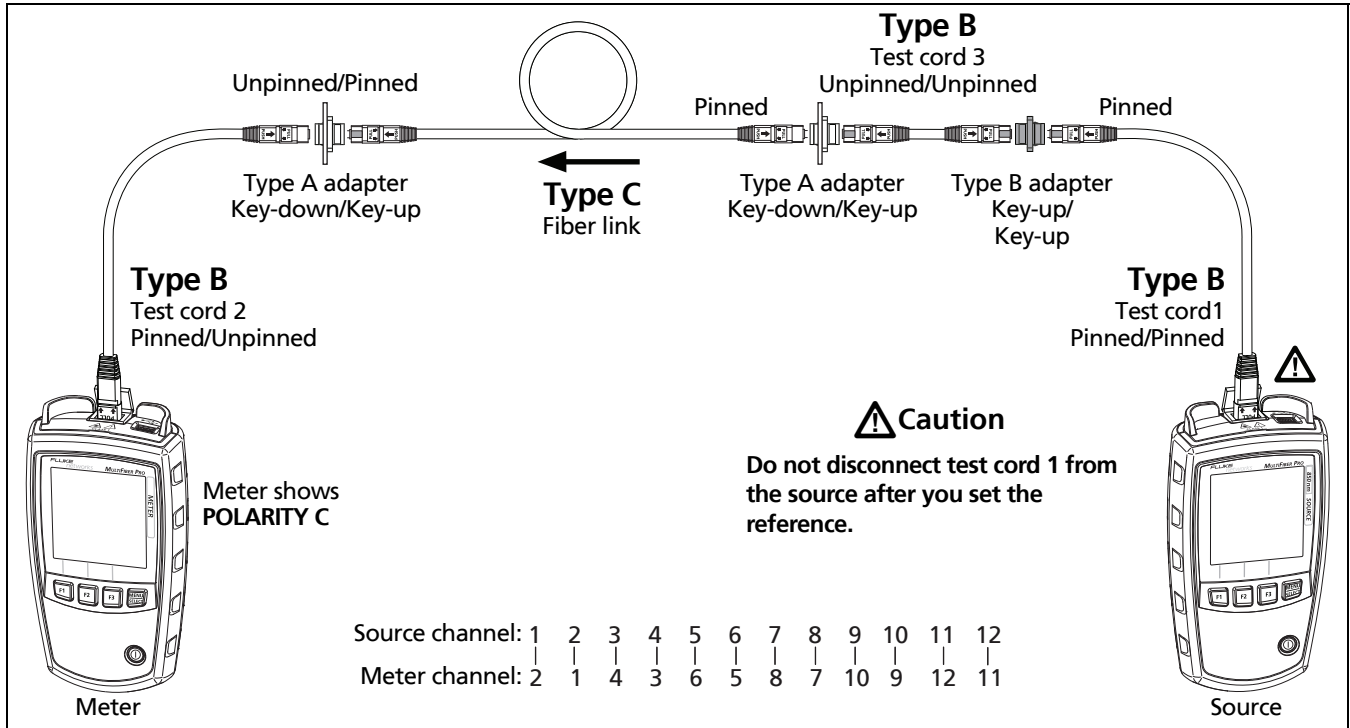

GUE22.EPS

Figure B-12. Connections Loss Measurements on Type C Multimode Permanent Links with Pinned MTP/MPO Connectors

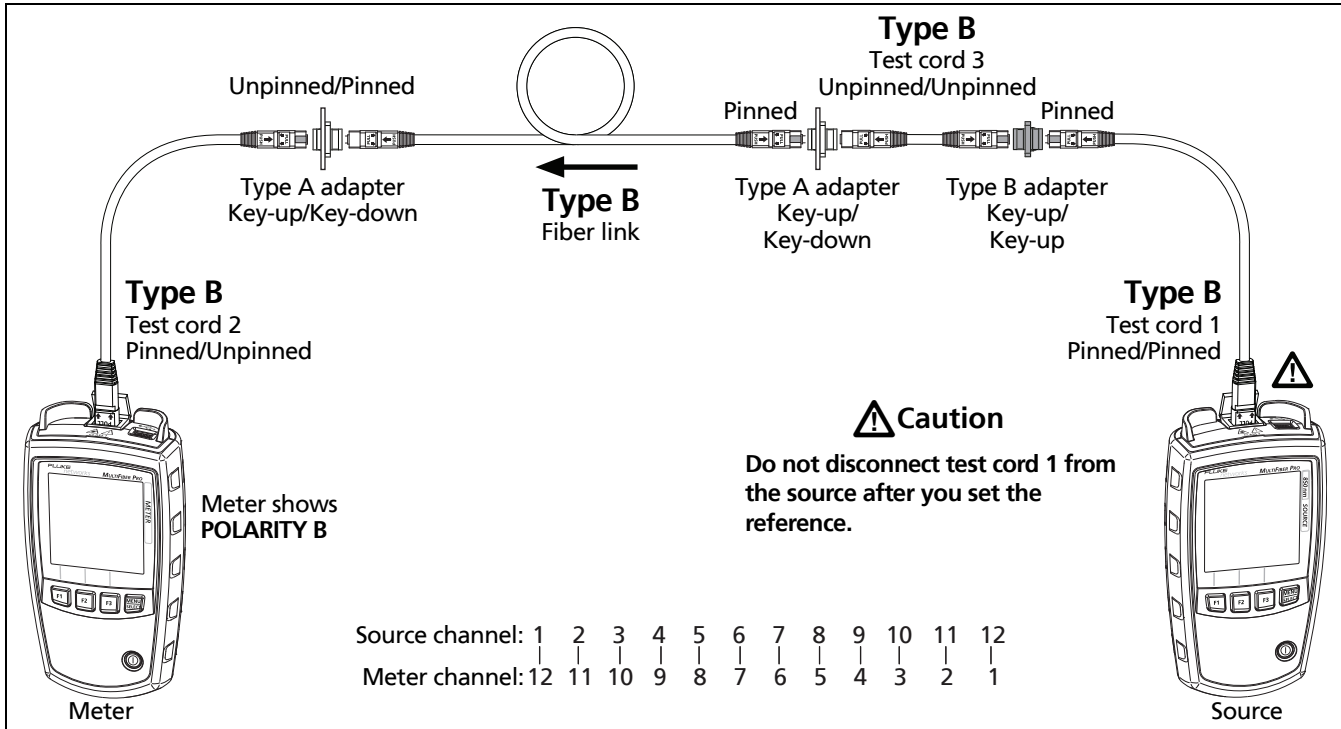

GUE15.EPS

Figure B-13. Connections for Loss Measurements on Multimode Permanent Links with Pinned MTP/MPO Connectors when Links are Used with Corning Plug & Play™ Universal Systems

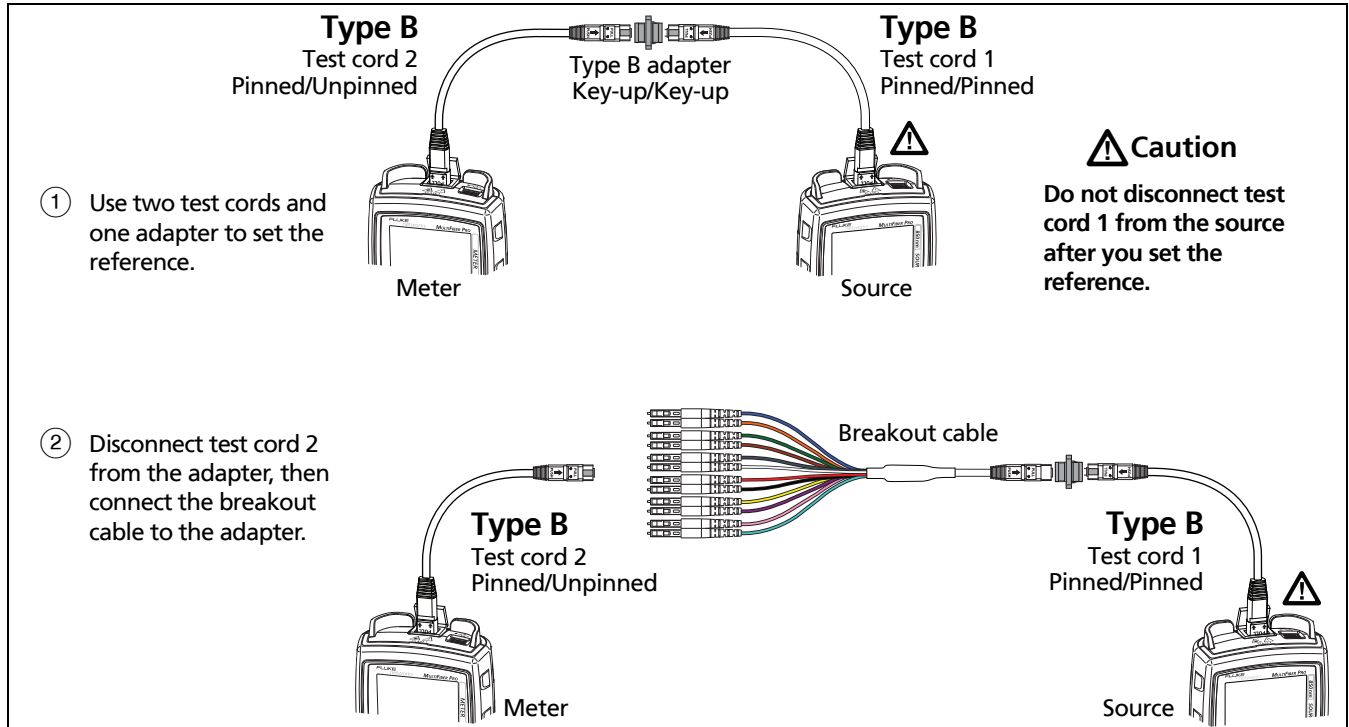

GUE17.EPS

Figure B-14. Reference Connections for Multimode Fiber Modules with Pinned MTP/MPO Connectors

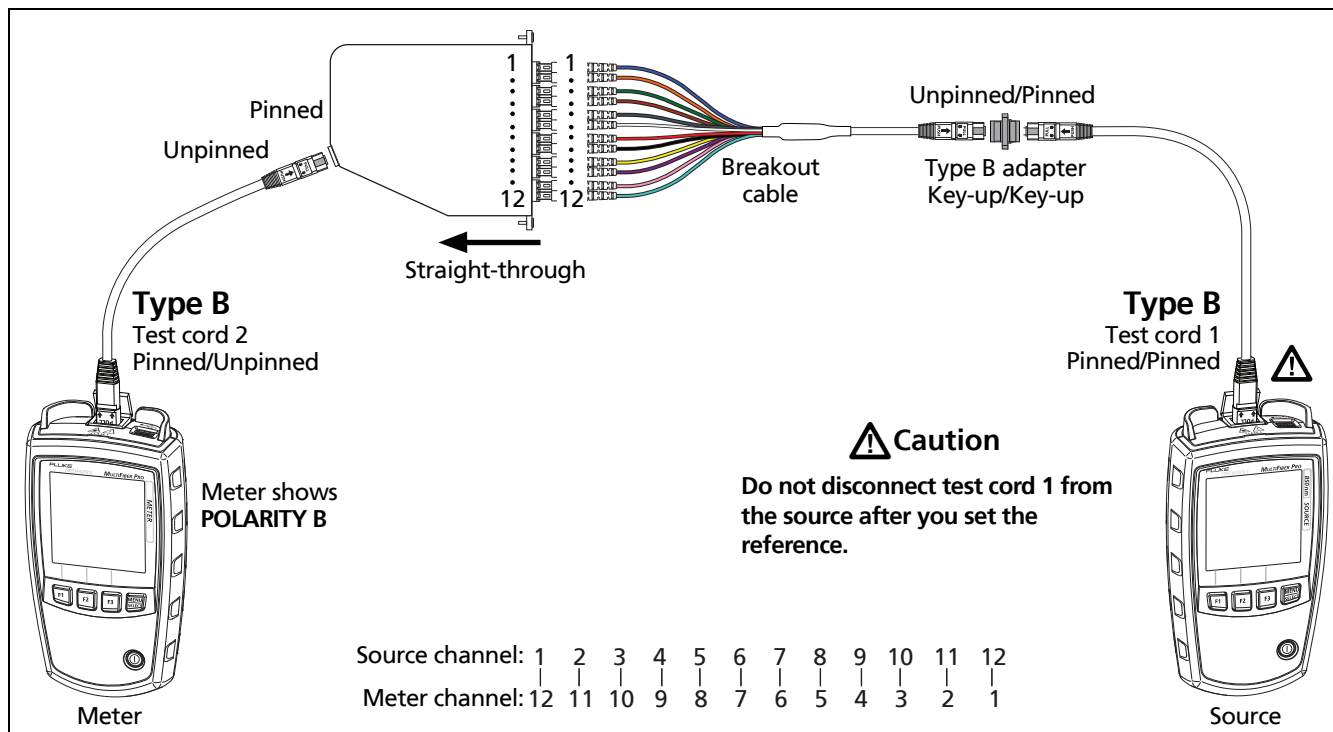

GUE16.EPS

Figure B-15. Connections for Loss Measurements on a Straight-Through Multimode Fiber Module with a Pinned MTP/MPO Connector

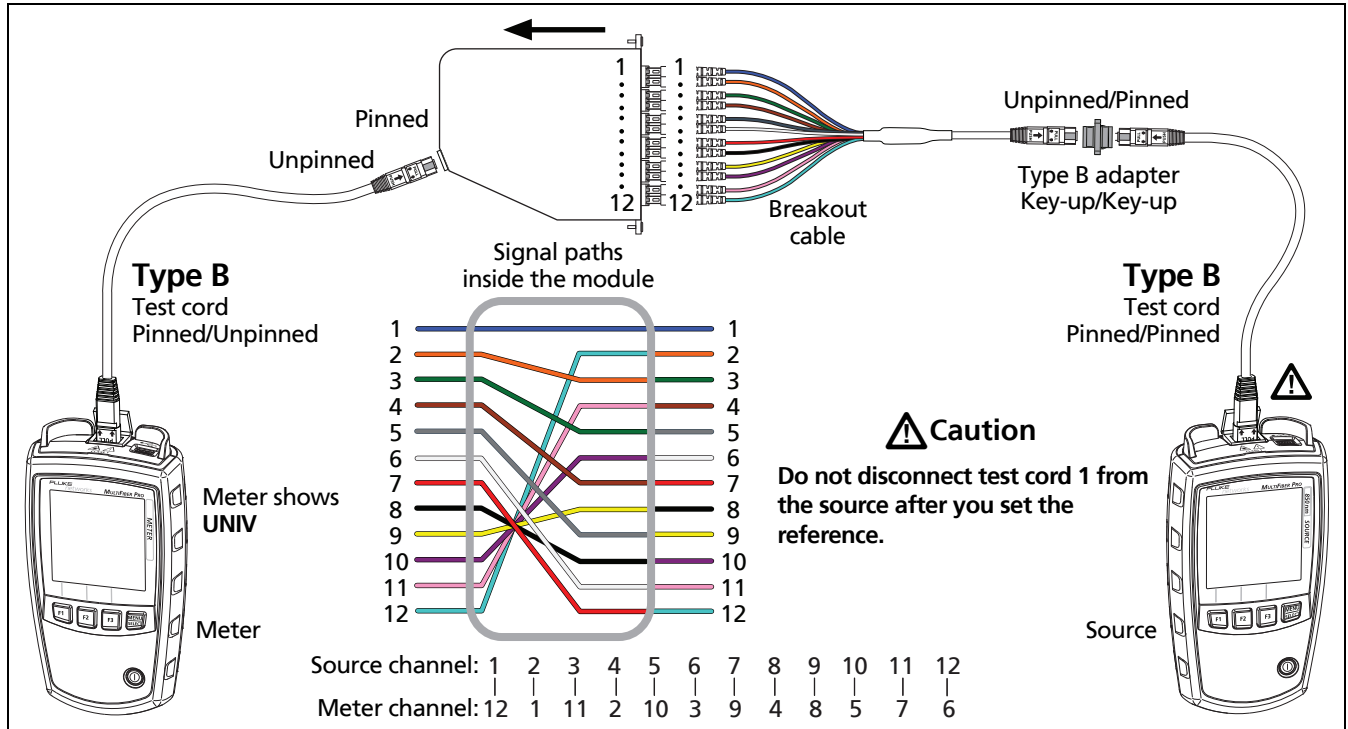

GUE18.EPS

Figure B-16. Connections for Loss Measurements on a Multimode Corning Plug & Play™ Universal Systems Module

