

REV	DATE	DESCRIPTION	ECO	BY	C'H'K.
M	2017-10-31 00:00:00 EDT	YA8C2TC38E16 & YA1C2TC38E16 CATALOG ADDED TO SHEET 2 & 7 RLY	47886	BK	MB

CONNECTOR SIZE	TOLERANCES						
	B	C	E	K DIA.	L	N	O.D.
-6C	±.03	+0.04 -.02	±.02	±.02	±.06	±.04	±.01
-8C THRU -25	±.06	±.04	±.02	±.02	±.09	±.04	±.01
-26 THRU -34	±.08	±.04	±.02	±.02	±.12	±.04	±.01
-35 AND UP	±.09	±.06	±.02	±.02	±.15	±.06	±.01

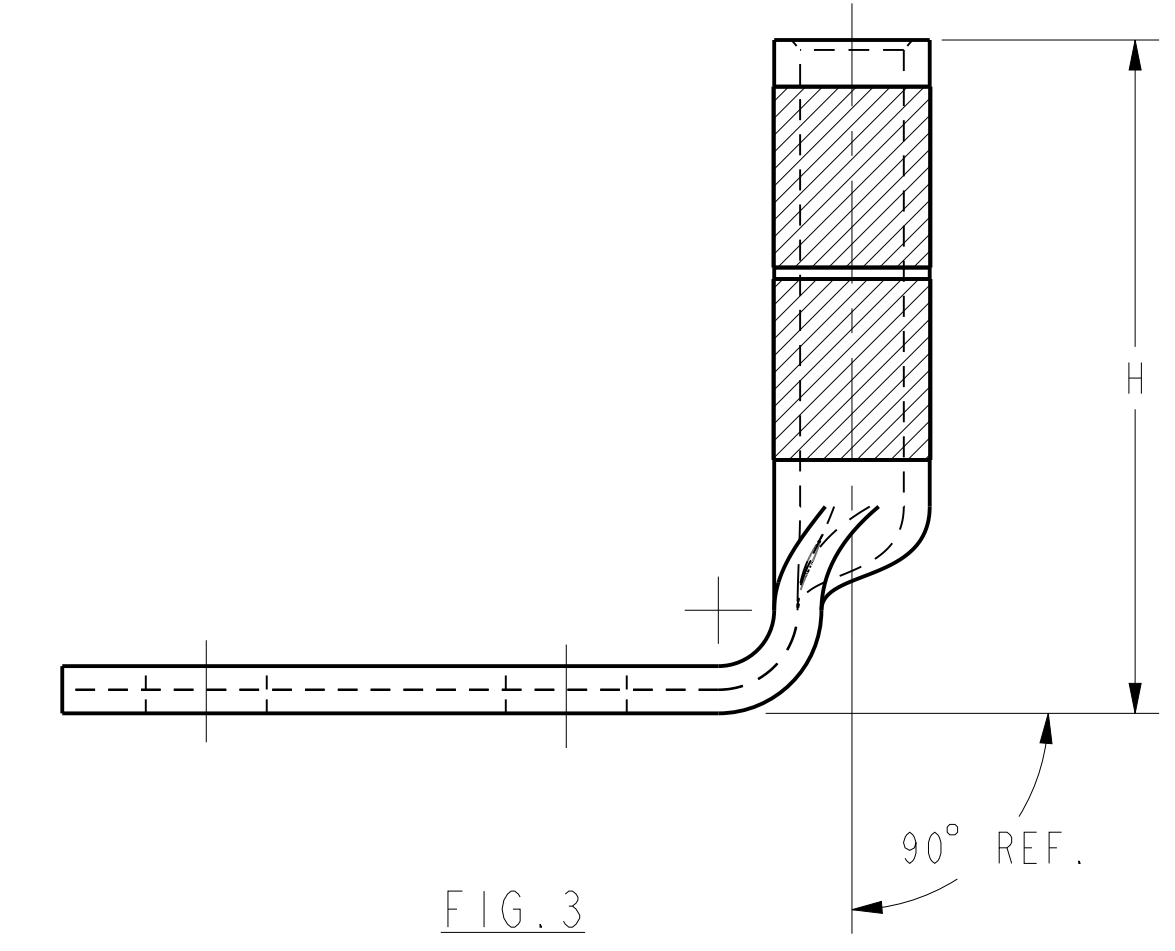
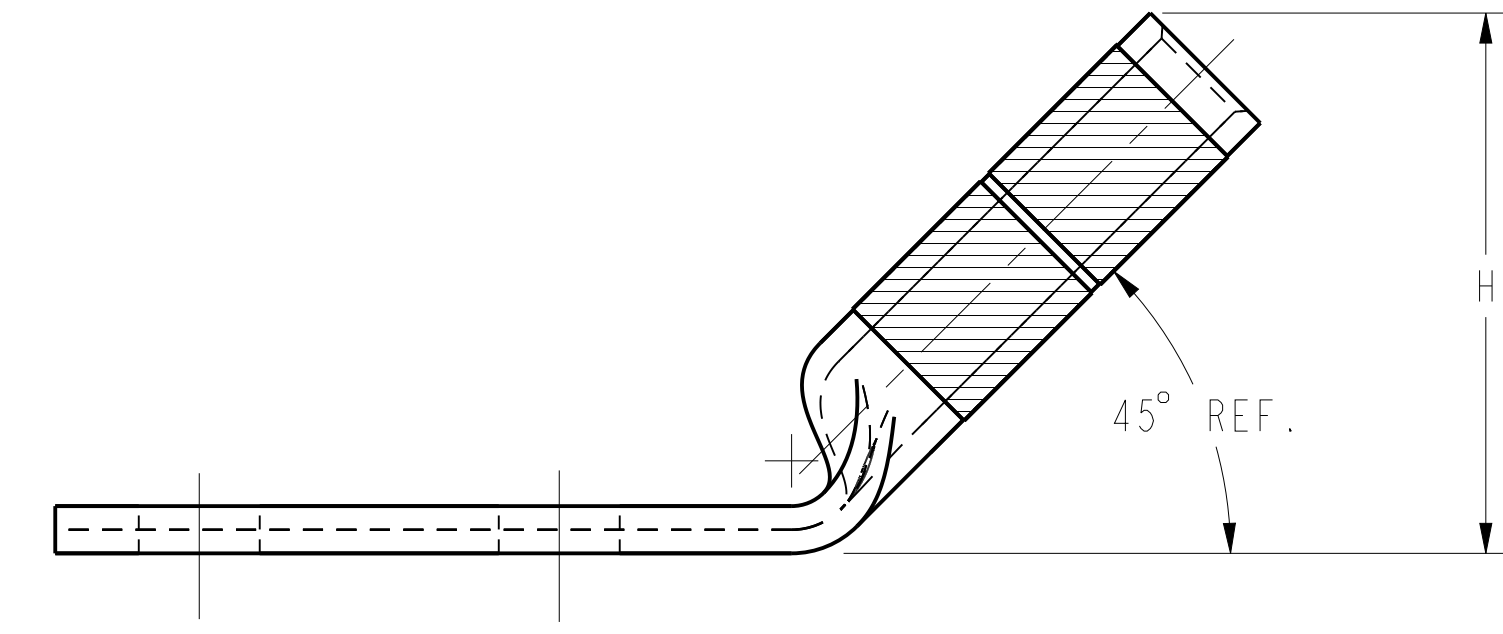
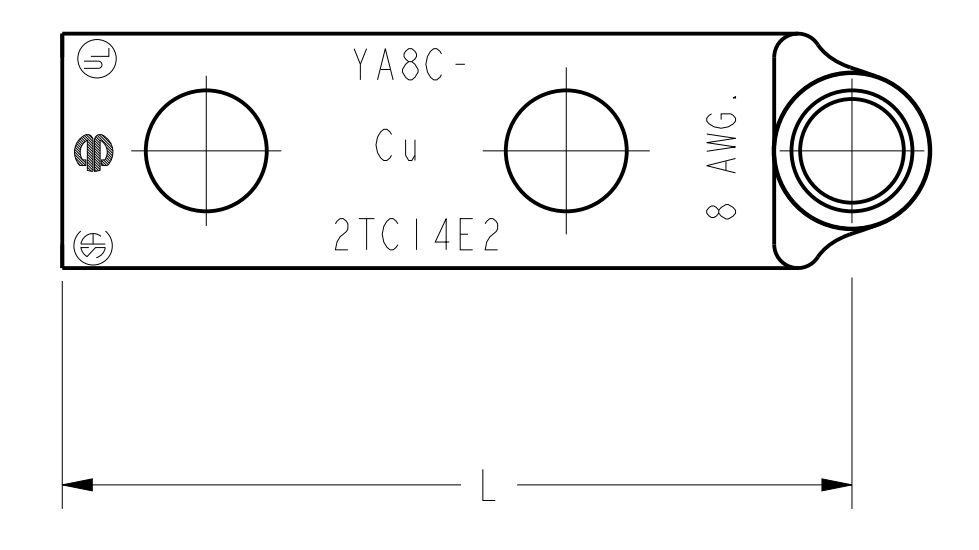
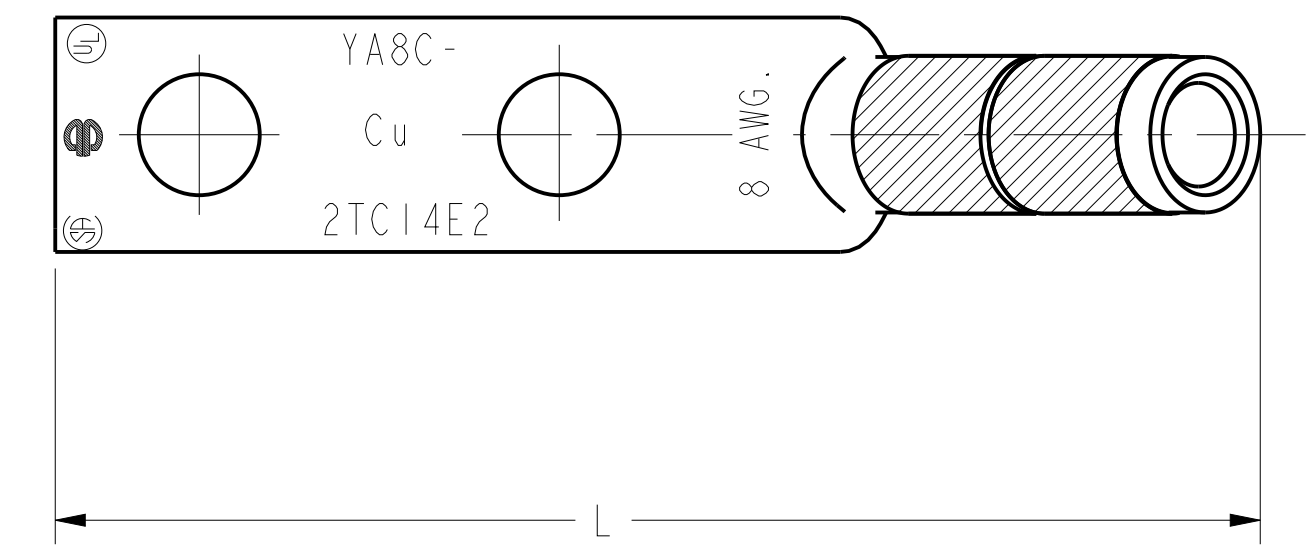
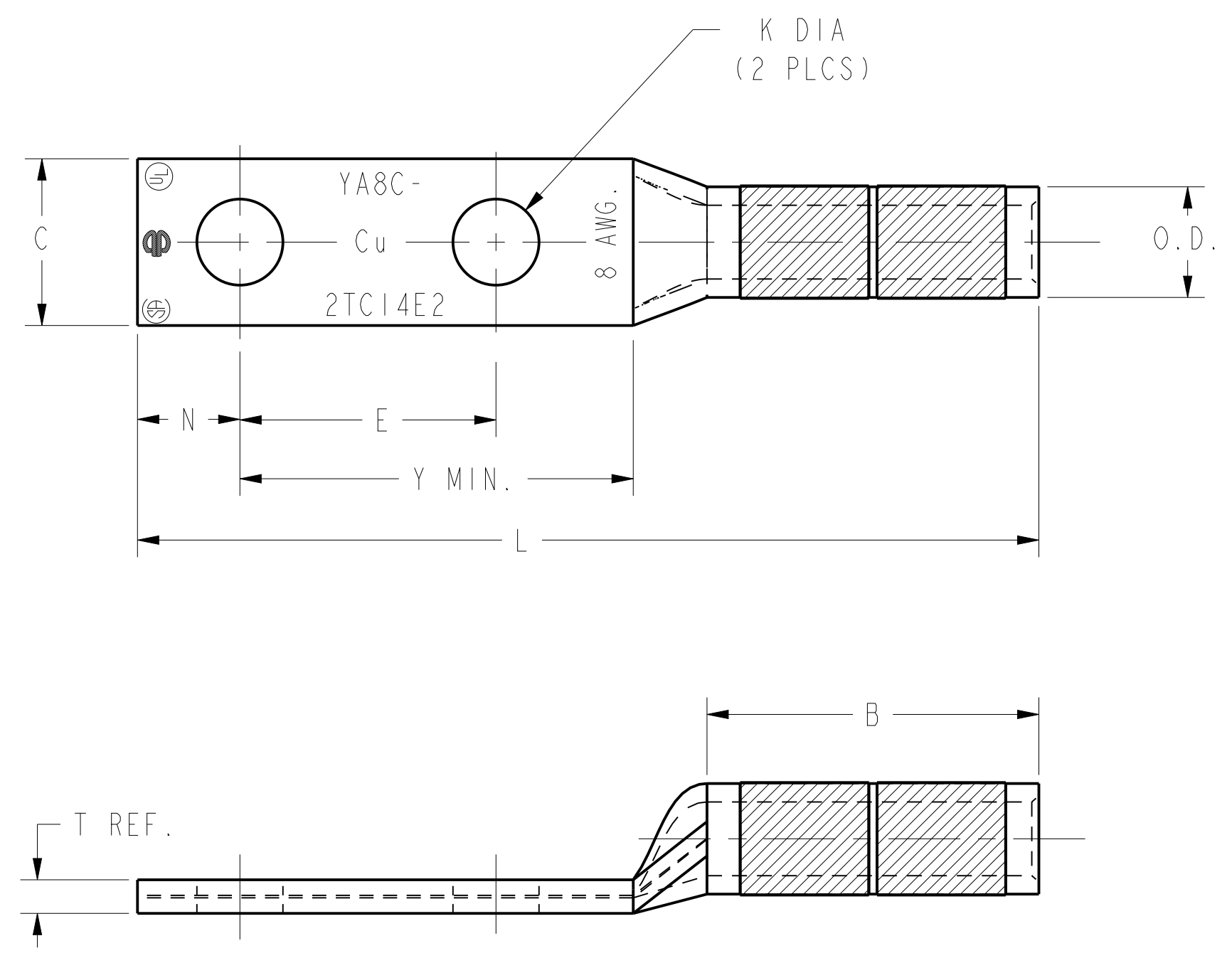

- NOTES:
1. MATERIAL : COPPER TUBING.
 2. FINISH: TIN PLATED.
 3. CATALOG # PT6515 ADAPTOR IS REQUIRED TO USE "U" DIES IN Y45 SERIES TOOLS.
 4. CATALOG # PUADP-1 ADAPTOR IS REQUIRED TO USE "U" DIES IN Y46 SERIES TOOLS.
 5. NAVY CABLE SIZE MAY BE OMITTED ON SOME SIZES BECAUSE OF SPACE LIMITATIONS.
 6. PERMANENT DIE IN TOOLING.
 7. DIMENSIONS IN BRACKETS [] ARE IN MILLIMETERS ROUNDED OFF TO THE NEAREST MILLIMETER, UNLESS OTHERWISE NOTED, AND ARE FOR REFERENCE ONLY.
 8. FOR USE BY CUSTOMERS THAT HAVE THIS HYPRESS™. NO NEW Y34 HYPRESSES™ TOOLS ARE BEING PROCESSED.
 9. OVERLAPPING CRIMPS ARE REQUIRED ON THESE SIZES.
 10. UL LISTED AND CSA CERTIFIED WIRE CONNECTORS.
 11. DO NOT USE PAT644 OR Y644 TOOLING WITH 6 AWG SOL.
 12. THESE CATALOG NUMBERS CANNOT BE INSTALLED WITH U8CRT DIE.
 13. THESE CATALOG NUMBERS CANNOT BE INSTALLED WITH Y45 OR Y46 TOOLING.
 14. THESE CATALOG NUMBERS CANNOT BE INSTALLED WITH Y45 TOOLING.

TO ORDER BURNDY® PRODUCTS CALL		HYLUG™	
UNITED STATES 1-800-346-4175 (LONDONDERRY, NH)		ITEM NO: N/A	CAT. NO: YA-2TC- (TABLE)
CANADA: 1-800-361-6975 (QUEBEC) 1-800-387-6487 (ALL OTHER PROVINCES)		DRAWN BY: J. MICHAUD 11/8/93	CHECKER: R. ROBICHEAU 1/10/94
FOR PRODUCT INFO: http://www.burndy.com		DSN APPVL: C. PALAGI 1/12/94	MFG APPVL: N/A --
		QA APPVL: A. LLOYD 1/24/94	MKT APPVL: G. GORDON 1/20/94
		PROD FAM: CM&R COMPRESSION	DRAWING NO: SE208777
		PROJECT #: --	SCALE: NTS
		DOCUMENT TYPE: Sales	SIZE: D
		REL LEVEL: Released	SHEET 1 OF 20

REV: PEC200

REV	DATE	DESCRIPTION	ECO	BY	CHK.
M	2017-10-31 00:00:00 EDT	YA8C2TC38E16 & YA1C2TC38E16 CATALOG ADDED TO SHEET 2 & 7 RLY	47886	BK	MB

D	CATALOG NO.	FIG. NO.	CONDUCTOR		BOLT SIZE	DIMENSIONS								INSTALLATION TOOLING (# CRIMPS)								WIRE STRIP LENGTH																																																																																																																																																																																																																																																																																				
			CODE (AWG)	NAVY		B	C	E	H	K	L	N	O.D.	T REF.	Y MIN.	DIE INDEX	COLOR CODE	MECHANICAL			HYDRAULIC			DIELESS (# CRIMPS)																																																																																																																																																																																																																																																																																		
																		MD7-34R MD6	OUR840	Y8MRB-1 Y1MRTC Y122CMR	Y500CT PAT600		Y750,Y35 Y39, PAT750		Y46 PAT46	Y45																																																																																																																																																																																																																																																																																
	YA8C2TC10	1	#8 STR #8 SOL #8 FLEX CLASS G, H, I, K, M DLO (37/24) #6 SOL	23	#10 [M5]	.81 [21]	.41 [10]	.62 [16]	-	.21 [5]	2.20 [56]	.25 [6]	.27 [7]	.08 [2]	.90 [23]	▲	RAD	W8CRT (1) W8CVT (1)	X8CRT (1) W8CVT (1)	RED (1)	W8CRT (1) W8CVT (1)	U8CRT (1)	U8CRT (1)	U8CRT (1)	MECHANICAL: MY29-11 (1)	7/8																																																																																																																																																																																																																																																																																
	YA8C2TC1045	2																									1/4 [M6]	.44 [11]	.62 [16]	.94 [24]	1.17 [30]	2.33 [59]	.31 [8]	2.09 [53]	.96 [24]	▲	RED	W8CRT (1) W8CVT (1)	X8CRT (1) W8CVT (1)	RED (1)	W8CRT (1) W8CVT (1)	U8CRT (1)	U8CRT (1)	U8CRT (1)	MECHANICAL: MY29-11 (1)	7/8																																																																																																																																																																																																																																																												
	YA8C2TC1090	3																																													1/4 [M6]	.44 [11]	.62 [16]	.94 [24]	1.17 [30]	2.33 [59]	.31 [8]	2.09 [53]	.96 [24]	▲	RED	W8CRT (1) W8CVT (1)	X8CRT (1) W8CVT (1)	RED (1)	W8CRT (1) W8CVT (1)	U8CRT (1)	U8CRT (1)	U8CRT (1)	MECHANICAL: MY29-11 (1)	7/8																																																																																																																																																																																																																																								
	YA8C2TC14	1																																																																	1/4 [M6]	.44 [11]	.62 [16]	.94 [24]	1.17 [30]	2.33 [59]	.31 [8]	2.09 [53]	.96 [24]	▲	RED	W8CRT (1) W8CVT (1)	X8CRT (1) W8CVT (1)	RED (1)	W8CRT (1) W8CVT (1)	U8CRT (1)	U8CRT (1)	U8CRT (1)	MECHANICAL: MY29-11 (1)	7/8																																																																																																																																																																																																																				
	YA8C2TC1445	2																																																																																					1/4 [M6]	.44 [11]	.62 [16]	.94 [24]	1.17 [30]	2.33 [59]	.31 [8]	2.09 [53]	.96 [24]	▲	RED	W8CRT (1) W8CVT (1)	X8CRT (1) W8CVT (1)	RED (1)	W8CRT (1) W8CVT (1)	U8CRT (1)	U8CRT (1)	U8CRT (1)	MECHANICAL: MY29-11 (1)	7/8																																																																																																																																																																																																
	YA8C2TC1490	3																																																																																																									1/4 [M6]	.44 [11]	.62 [16]	.94 [24]	1.17 [30]	2.33 [59]	.31 [8]	2.09 [53]	.96 [24]	▲	RED	W8CRT (1) W8CVT (1)	X8CRT (1) W8CVT (1)	RED (1)	W8CRT (1) W8CVT (1)	U8CRT (1)	U8CRT (1)	U8CRT (1)	MECHANICAL: MY29-11 (1)	7/8																																																																																																																																																																												
	YA8C2TC14E2	1																																																																																																																													1/4 [M6]	.44 [11]	.62 [16]	.94 [24]	1.17 [30]	2.33 [59]	.31 [8]	2.09 [53]	.96 [24]	▲	RED	W8CRT (1) W8CVT (1)	X8CRT (1) W8CVT (1)	RED (1)	W8CRT (1) W8CVT (1)	U8CRT (1)	U8CRT (1)	U8CRT (1)	MECHANICAL: MY29-11 (1)	7/8																																																																																																																																																								
	YA8C2TC14E245	2																																																																																																																																																	1/4 [M6]	.44 [11]	.62 [16]	.94 [24]	1.17 [30]	2.33 [59]	.31 [8]	2.09 [53]	.96 [24]	▲	RED	W8CRT (1) W8CVT (1)	X8CRT (1) W8CVT (1)	RED (1)	W8CRT (1) W8CVT (1)	U8CRT (1)	U8CRT (1)	U8CRT (1)	MECHANICAL: MY29-11 (1)	7/8																																																																																																																																				
	YA8C2TC14E290	3																																																																																																																																																																					1/4 [M6]	.44 [11]	.62 [16]	.94 [24]	1.17 [30]	2.33 [59]	.31 [8]	2.09 [53]	.96 [24]	▲	RED	W8CRT (1) W8CVT (1)	X8CRT (1) W8CVT (1)	RED (1)	W8CRT (1) W8CVT (1)	U8CRT (1)	U8CRT (1)	U8CRT (1)	MECHANICAL: MY29-11 (1)	7/8																																																																																																																
	YA8C2TC14E1	1																																																																																																																																																																																									1/4 [M6]	.44 [11]	.62 [16]	.94 [24]	1.17 [30]	2.33 [59]	.31 [8]	2.09 [53]	.96 [24]	▲	RED	W8CRT (1) W8CVT (1)	X8CRT (1) W8CVT (1)	RED (1)	W8CRT (1) W8CVT (1)	U8CRT (1)	U8CRT (1)	U8CRT (1)	MECHANICAL: MY29-11 (1)	7/8																																																																																												
	YA8C2TC38	1																																																																																																																																																																																																													3/8 [M10]	.81 [21]	1.00 [25]	1.75 [44]	1.00 [25]	.93 [24]	.41 [10]	2.89 [73]	.41 [10]	.27 [7]	.08 [2]	1.43 [36]	▼	RED	W8CRT (1) W8CVT (1)	X8CRT (1) W8CVT (1)	RED (2)	W8CRT (1) W8CVT (1)	U8CRT (1)	U8CRT (1)	U8CRT (1)	MECHANICAL: MY29-11 (1)	7/8																																																																					
	YA8C2TC38E16	1																																																																																																																																																																																																																																				3/8 [M10]	.81 [21]	1.00 [25]	1.75 [44]	1.00 [25]	.93 [24]	.41 [10]	2.89 [73]	.41 [10]	.27 [7]	.06 [2]	2.18 [55]	▼	RED	W8CRT (1) W8CVT (1)	X8CRT (1) W8CVT (1)	RED (2)	W8CRT (1) W8CVT (1)	U8CRT (1)	U8CRT (1)	U8CRT (1)	MECHANICAL: MY29-11 (1)	7/8																																														
	YA8C2TC3845	2																																																																																																																																																																																																																																																											3/8 [M10]	.81 [21]	1.00 [25]	1.75 [44]	1.00 [25]	.93 [24]	.41 [10]	2.89 [73]	.41 [10]	.27 [7]	.06 [2]	2.18 [55]	▼	RED	W8CRT (1) W8CVT (1)	X8CRT (1) W8CVT (1)	RED (2)	W8CRT (1) W8CVT (1)	U8CRT (1)	U8CRT (1)	U8CRT (1)	MECHANICAL: MY29-11 (1)	7/8																							
	YA8C2TC3890	3																																																																																																																																																																																																																																																																																		3/8 [M10]	.81 [21]	1.00 [25]	1.75 [44]	1.00 [25]	.93 [24]	.41 [10]	2.89 [73]	.41 [10]	.27 [7]	.06 [2]	2.18 [55]	▼	RED	W8CRT (1) W8CVT (1)	X8CRT (1) W8CVT (1)	RED (2)	W8CRT (1) W8CVT (1)	U8CRT (1)	U8CRT (1)	U8CRT (1)	MECHANICAL: MY29-11 (1)	7/8

B	C	D
---	---	---

SEE SHEET 1 OF 20 FOR VIEWS AND NOTE.

TO ORDER BURNDY® PRODUCTS CALL UNITED STATES 1-800-346-4175 (LONDONDERRY, NH) CANADA: 1-800-361-6975 (QUEBEC) 1-800-387-6487 (ALL OTHER PROVINCES) FOR PRODUCT INFO: http://www.burndy.com		HYLUG™ ITEM NO: N/A CAT. NO: YA-2TC- (TABLE) DRAWN BY: J.MICHAUD 11/8/93 CHECKER: R.ROBICHEAU 1/10/94 DSN APPVL: C.PALAGI 1/12/94 MFG APPVL: N/A -- QA APPVL: A.LLOYD 1/24/94 MKT APPVL: G.GORDON 1/20/94 PROD FAM: CM&R COMPRESSION PROJECT #: -- DOCUMENT TYPE: Sales REL LEVEL: Released	
SCALE: NTS DRAWING NO: SE208777 SHEET 2 OF 20		REV: M	

REV: PEO200

D

D

C

C

B

B

A

A

CATALOG NO.	FIG. NO.	CONDUCTOR		BOLT SIZE	DIMENSIONS									INSTALLATION TOOLING (# CRIMPS)												
		CODE (AWG)	NAVY		B	C	E	H	K	L	N	O.D.	T REF.	Y MIN.	DIE INDEX	COLOR CODE	MECHANICAL			HYDRAULIC				DIELESS (# CRIMPS)	WIRE STRIP LENGTH	
																	MD7-34R MD6	OUR840	YIMRTC 6 Y122CMR	BCT500 Y500CT	Y34A 8	Y750, PAT750 Y35, Y39	Y46 4			Y45 3
YA6C2TC10	1	#6 STR	30	#10 [M5]	1.12 [28]	.42 [11]	.62 [16]	-	.21 [5]	2.53 [64]	.25 [6]	.29 [7]	.09 [2]	.90 [23]	7 OR 374	BLUE	W5CVT W5CRT (2)	W5CVT W5CRT (2)	BLUE (2)	W5CVT W5CRT (2)	A5CR (2)	U8CABT U5CRT (2)	U8CABT U5CRT (2)	U8CABT U5CRT (2)		1-3/16
YA6C2TC1045	2	#6 SOL		#10 [M5]																						
YA6C2TC1090	3																									
YA6C2TC10E2	1																									
YA6C2TC10E245	2			#10 [M5]		.42 [11]	.75 [19]	1.19 [30]	.21 [5]	2.48 [63]	.25 [6]		.09 [2]	1.03 [26]												
YA6C2TC10E290	3																									
YA6C2TC14	1																									
YA6C2TC1445	2			1/4 [M6]		.45 [11]	.62 [16]	1.19 [30]	.27 [7]	2.45 [62]	.31 [8]		.08 [2]	.96 [24]												
YA6C2TC1490	3																									
YA6C2TC14E1	1																									
YA6C2TC14E145	2			1/4 [M6]		.45 [11]	1.00 [25]	1.19 [30]	.27 [7]	2.83 [72]	.31 [8]		.08 [2]	1.34 [34]												
YA6C2TC14E190	3																									
YA6C2TC14E2	1																									
YA6C2TC14E245	2			1/4 [M6]		.45 [11]	.75 [19]	1.19 [30]	.27 [7]	2.58 [66]	.31 [8]		.08 [2]	1.09 [28]												
YA6C2TC14E290	3																									
YA6C2TC516E6	1																									
YA6C2TC516E645	2			5/16 [M8]		.52 [13]	.88 [22]	1.18 [30]	.33 [8]	2.72 [69]	.34 [9]		.07 [2]	1.24 [31]												
YA6C2TC516E690	3																									
YA6C2TC38	1																									
YA6C2TC3845	2			3/8 [M10]		.58 [15]	1.00 [25]	1.18 [30]	.41 [10]	2.97 [75]	.41 [10]		.06 [2]	1.43 [36]												
YA6C2TC3890	3																									
YA6C2TC38E2	1																									
YA6C2TC38E245	2					.75 [19]		1.18 [30]		2.72 [69]				1.18 [30]												
YA6C2TC38E290	3																									
YA6C2TC38E6	1																									
YA6C2TC38E645	2					.88 [22]		1.18 [30]		2.85 [72]				1.31 [33]												
YA6C2TC38E690	3																									
YA6C2TC38E13	1																									
YA6C2TC38E1345	2	#6 STR	30	3/8 [M10]		.58 [15]	.81 [21]	1.18 [30]	.41 [10]	2.78 [71]	.41 [10]		.29 [7]	1.24 [31]												
YA6C2TC38E1390	3	#6 SOL																								

SEE SHEET 1 OF 20 FOR VIEWS AND NOTES

TO ORDER BURNDY® PRODUCTS CALL		HYLUG™	
UNITED STATES 1-800-346-4175 (LONDONDERRY, NH)		ITEM NO: N/A	
CANADA: 1-800-361-6975 (QUEBEC) 1-800-387-6487 (ALL OTHER PROVINCES)		CAT. NO: YA-2TC- (TABLE)	
FOR PRODUCT INFO: http://www.burndy.com		DRAWN BY: J.MICHAUD 11/8/93	
		CHECKER: R.ROBICHEAU 1/10/94	
		DSN APPVL: C.PALAGI 1/12/94	
		MFG APPVL: N/A --	
		QA APPVL: A.LLOYD 1/24/94	
		MKT APPVL: G.GORDON 1/10/94	
		SCALE: NTS	
		PROD FAM: CM&R COMPRESSION	
		DRAWING NO	
		REV	
		PROJECT #: --	
		SIZE	
		SE208777	
		DOCUMENT TYPE: Sales	
		SHEET 3 OF 20	
		REL LEVEL: Released	

REV	DATE	DESCRIPTION	ECO	BY	C'H'K'
M	2017-10-31 00:00:00 EDT	YA8C2TC38E16 & YA1C2TC38E16 CATALOG ADDED TO SHEET 2 & 7 RLY	47886	BK	MB

REV: PE0200

REV	DATE	DESCRIPTION	ECO	BY	CHK.
M	2017-10-31 00:00:00 EDT	YA8C2TC38E16 & YA1C2TC38E16 CATALOG ADDED TO SHEET 2 & 7 RLY	47886	BK	MB

D	CATALOG NO.	FIG. NO.	CONDUCTOR		BOLT SIZE	DIMENSIONS								INSTALLATION TOOLING (# CRIMPS)													
			CODE (AWG)	NAVY		B	C	E	H	K	L	N	O.D.	T REF.	Y MIN.	DIE INDEX	COLOR CODE	MECHANICAL			HYDRAULIC				DIELESS (# CRIMPS)	WIRE STRIP LENGTH	
																		MD7-34R MD6	OUR840	Y1MRTG 6 Y122CMR	BCT500 Y500CT	Y34A 8	Y750, Y35 Y39 PAT750	Y46 4			Y45 3
	YA4C2TC10	1	#4 AWG	40	#10	1.12 [28]	.50 [13]	.62 [16]	-	.21 [5]	2.58 [66]	.25 [6]	.34 [9]	.09 [2]	.90 [23]	8 OR 346	GRAY	W4CVT W4CRT (2)	W4CVT W4CRT (2)	GRAY (4)	W4CVT W4CRT (2)	A6CAB A4CR (2)	U6CABT U4CRT (2)	U6CABT U4CRT (2)	U6CABT U4CRT (2)	MECHANICAL: MY29-11 (1) HYDRAULIC: Y644, Y644M Y644MBH, BAT644M, PAT644M, Y1000 Y1000BH (1)	1-3/16
	YA4C2TC1045	2	↑	↑	[M5]	↑	↑	↑	↑	↑	↑	↑	↑	↑	↑	↑	↑	↑	↑	↑	↑	↑	↑	↑	↑		↑
	YA4C2TC1090	3	↑	↑																							
	YA4C2TC14	1	↑	↑	1/4																						
	YA4C2TC1445	2	↑	↑	[M6]																						
	YA4C2TC1490	3	↑	↑																							
	YA4C2TC14E2	1	↑	↑	1/4																						
C	YA4C2TC14E245	2	↑	↑	[M6]																						
	YA4C2TC14E290	3	↑	↑																							
	YA4C2TC14E1	1	↑	↑	1/4																						
	YA4C2TC14E145	2	↑	↑	[M6]																						
	YA4C2TC14E190	3	↑	↑																							
	YA4C2TC38	1	↑	↑	3/8																						
	YA4C2TC3845	2	↓	↓	[M8]	1.12 [28]	.58 [15]	1.00 [25]	-	.40 [10]	3.03 [77]	.41 [10]	.34 [9]	.08 [2]	1.43 [36]	8 OR 346	GRAY	W4CVT W4CRT (2)	W4CVT W4CRT (2)	GRAY (4)	W4CVT W4CRT (2)	A6CAB A4CR (2)	U6CABT U4CRT (2)	U6CABT U4CRT (2)	U6CABT U4CRT (2)		1-3/16
	YA4C2TC3890	3	↓	↓																							

B

A

SEE SHEET 1 OF 20 FOR VIEWS & NOTES

TO ORDER BURNDY® PRODUCTS CALL		HYLUG™	
UNITED STATES 1-800-346-4175 (LONDONDERRY, NH)		ITEM NO: N/A	
CANADA: 1-800-361-6975 (QUEBEC) 1-800-387-6487 (ALL OTHER PROVINCES)		CAT. NO: YA4C-2TC- (TABLE)	
FOR PRODUCT INFO: http://www.burndy.com		DRAWN BY: J.MICHAUD 11/8/93	
		CHECKER: R.ROBICHEAU 1/10/94	
		DSN APPVL: C.PALAGI 1/12/94	
		MFG APPVL: N/A --	
		QA APPVL: A.LLOYD 1/24/94	
		MKT APPVL: G.GORDON 1/10/94	
		SCALE: NTS	
		PROD FAM: CM&R COMPRESSION	
		DRAWING NO	
		REV	
		PROJECT #: --	
		SIZE	
		SE208777	
		DOCUMENT TYPE: Sales	
		SHEET 4 OF 20	
		REL LEVEL: Released	



REV: PEO200

REV	DATE	DESCRIPTION	ECO	BY	C'H'K.
M	2017-10-31 00:00:00 EDT	YA8C2TC38E16 & YA1C2TC38E16 CATALOG ADDED TO SHEET 2 & 7 RLY	47886	BK	MB

D	CATALOG NO.	FIG. NO.	CONDUCTOR			BOLT SIZE	METRIC BOLT SIZE	DIMENSIONS								INSTALLATION TOOLING (# CRIMPS)													
			CODE (AWG)	NAVY	METRIC			B	C	E	H	K	L	N	O.D.	T REF.	Y MIN.	DIE INDEX	COLOR CODE	MECHANICAL			HYDRAULIC				DIELESS (# CRIMPS)	WIRE STRIP LENGTH	
																				MD7-34R MD6	OUR840	Y1MRTC Y122CMR	BCT500 Y500CT	Y34A	Y750, Y35 Y39	Y46			Y45
	YA3C2TC38E2	1	#2 SOL #3 AWG	50	25mm ²	3/8	----	1.25 [32]	.58 [15]	.75 [19]	-	.40 [10]	3.18 [81]	.41 [10]	.38 [10]	.08 [2]	1.18 [30]	9	WHITE	W3CRT (2)	W3CRT (2)	WHITE (4)	W3CRT (2)	A3CR (2)	U3CRT (2)	U3CRT (2)	U3CRT (2)	MECHANICAL: MY29-11(1) HYDRAULIC: Y644, Y644M Y644MBH, BAT644M Y1000 Y1000BH(1)	1-5/16
	YA3C2TC38E245	2				3/8	----	1.25 [32]	.58 [15]	.75 [19]	1.40 [36]	.40 [10]	3.16 [74]	.41 [10]	.38 [10]	.08 [2]	1.18 [30]	9	WHITE	W3CRT (2)	W3CRT (2)	WHITE (4)	W3CRT (2)	A3CR (2)	U3CRT (2)	U3CRT (2)	U3CRT (2)		
	YA3C2TC38E290	3				3/8	----	1.25 [32]	.58 [15]	.75 [19]	1.72 [44]	.40 [10]	3.43 [87]	.41 [10]	.38 [10]	.08 [2]	1.18 [30]	9	WHITE	W3CRT (2)	W3CRT (2)	WHITE (4)	W3CRT (2)	A3CR (2)	U3CRT (2)	U3CRT (2)	U3CRT (2)		
	YA3C2TC38	1				3/8	----	1.25 [32]	.58 [15]	.75 [19]	-	.40 [10]	3.16 [80]	.41 [10]	.38 [10]	.08 [2]	1.18 [30]	9	WHITE	W3CRT (2)	W3CRT (2)	WHITE (4)	W3CRT (2)	A3CR (2)	U3CRT (2)	U3CRT (2)	U3CRT (2)		
	YA3C2TC3845	2				3/8	----	1.25 [32]	.58 [15]	.75 [19]	1.40 [36]	.40 [10]	3.16 [80]	.41 [10]	.38 [10]	.08 [2]	1.18 [30]	9	WHITE	W3CRT (2)	W3CRT (2)	WHITE (4)	W3CRT (2)	A3CR (2)	U3CRT (2)	U3CRT (2)	U3CRT (2)		
	YA3C2TC3890	3				3/8	----	1.25 [32]	.58 [15]	.75 [19]	1.72 [44]	.40 [10]	3.43 [87]	.41 [10]	.38 [10]	.08 [2]	1.18 [30]	9	WHITE	W3CRT (2)	W3CRT (2)	WHITE (4)	W3CRT (2)	A3CR (2)	U3CRT (2)	U3CRT (2)	U3CRT (2)		
	YA3C2TC14	1				1/4	M6	1.25 [32]	.55 [14]	.62 [16]	1.40 [36]	.27 [7]	2.87 [73]	.31 [8]	.38 [10]	.09 [2]	.96 [24]	9	WHITE	W3CRT (2)	W3CRT (2)	WHITE (4)	W3CRT (2)	A3CR (2)	U3CRT (2)	U3CRT (2)	U3CRT (2)		
	YA3C2TC1445	2				1/4	M6	1.25 [32]	.55 [14]	.62 [16]	1.40 [36]	.27 [7]	2.62 [67]	.31 [8]	.38 [10]	.09 [2]	.96 [24]	9	WHITE	W3CRT (2)	W3CRT (2)	WHITE (4)	W3CRT (2)	A3CR (2)	U3CRT (2)	U3CRT (2)	U3CRT (2)		
	YA3C2TC1490	3				1/4	M6	1.25 [32]	.55 [14]	.62 [16]	1.73 [44]	.27 [7]	3.11 [79]	.31 [8]	.38 [10]	.09 [2]	.96 [24]	9	WHITE	W3CRT (2)	W3CRT (2)	WHITE (4)	W3CRT (2)	A3CR (2)	U3CRT (2)	U3CRT (2)	U3CRT (2)		
	YA3C2TC14E2	1				1/4	M6	1.25 [32]	.55 [14]	.75 [19]	1.40 [36]	.27 [7]	2.99 [76]	.31 [8]	.38 [10]	.09 [2]	1.09 [28]	9	WHITE	W3CRT (2)	W3CRT (2)	WHITE (4)	W3CRT (2)	A3CR (2)	U3CRT (2)	U3CRT (2)	U3CRT (2)		
	YA3C2TC14E245	2	1/4	M6	1.25 [32]	.55 [14]	.75 [19]	1.40 [36]	.27 [7]	2.75 [70]	.31 [8]	.38 [10]	.09 [2]	1.09 [28]	9	WHITE	W3CRT (2)	W3CRT (2)	WHITE (4)	W3CRT (2)	A3CR (2)	U3CRT (2)	U3CRT (2)	U3CRT (2)					
	YA3C2TC14E290	3	1/4	M6	1.25 [32]	.55 [14]	.75 [19]	1.73 [44]	.27 [7]	3.24 [82]	.31 [8]	.38 [10]	.09 [2]	1.09 [28]	9	WHITE	W3CRT (2)	W3CRT (2)	WHITE (4)	W3CRT (2)	A3CR (2)	U3CRT (2)	U3CRT (2)	U3CRT (2)					
	YA3C2TC14E1	1	1/4	M6	1.25 [32]	.55 [14]	1.00 [25]	1.40 [36]	.27 [7]	3.00 [76]	.31 [8]	.38 [10]	.09 [2]	1.34 [34]	9	WHITE	W3CRT (2)	W3CRT (2)	WHITE (4)	W3CRT (2)	A3CR (2)	U3CRT (2)	U3CRT (2)	U3CRT (2)					
	YA3C2TC14E145	2	1/4	M6	1.25 [32]	.55 [14]	1.00 [25]	1.40 [36]	.27 [7]	3.00 [76]	.31 [8]	.38 [10]	.09 [2]	1.34 [34]	9	WHITE	W3CRT (2)	W3CRT (2)	WHITE (4)	W3CRT (2)	A3CR (2)	U3CRT (2)	U3CRT (2)	U3CRT (2)					
	YA3C2TC14E190	3	#3 AWG #2 SOL	50	25mm ²	1/4	M6	1.25 [32]	.55 [14]	1.73 [44]	.27 [7]	.38 [10]	.09 [2]	1.34 [34]	9	WHITE	W3CRT (2)	W3CRT (2)	WHITE (4)	W3CRT (2)	A3CR (2)	U3CRT (2)	U3CRT (2)	U3CRT (2)	1-5/16				

SEE SHEET 1 OF 20 FOR VIEWS AND NOTES

NOTE :

NOT FOR USE ON #2 SOL CONDUCTOR.

TO ORDER BURNDY® PRODUCTS CALL UNITED STATES 1-800-346-4175 (LONDONDERRY, NH) CANADA: 1-800-361-6975 (QUEBEC) 1-800-387-6487 (ALL OTHER PROVINCES) FOR PRODUCT INFO: http://www.burndy.com	HYLUG™		
	ITEM NO:	N/A	
	CAT. NO:	YA-2TC- (TABLE)	
	DRAWN BY:	J. MICHAUD	11/8/93
	CHECKER:	R. ROBICHEAU	1/10/94
	DSN APPVL:	C. PALAGI	1/12/94
	MFG APPVL:	N/A	--
	QA APPVL:	A. LLOYD	1/24/94
	MKT APPVL:	G. GORDON	1/20/94
	PROD FAM:	CM&R COMPRESSION	DRAWING NO
PROJECT #:	--	SIZE	SE208777
DOCUMENT TYPE:	Sales		M
REL LEVEL:	Released	D	SHEET 5 OF 20

REV: PEO200

CATALOG NO.	FIG. NO.	CONDUCTOR		BOLT SIZE	DIMENSIONS									INSTALLATION TOOLING (# CRIMPS)															
		CODE (AWG)	NAVY		B	C	E	H	K	L	N	O.D.	T REF.	Y MIN.	DIE INDEX	COLOR CODE	MECHANICAL			HYDRAULIC				DIELESS (# CRIMPS)	WIRE STRIP LENGTH				
																	MD7-34R MD6	OUR840	YIMRTC Y122CMR	Y34A	BCT500 Y500CT PAT600	Y750, Y35 Y39, PAT750	Y46			Y45			
YA2C2TC10	1	#2 AWG	60	#10 [15]	1.25 [32]	.60 [15]	.62 [16]	-	.21	2.74 [70]	.42 [11]	.11 [3]	.90 [23]	10	BROWN	W2CVT W2CRT (2)	W2CVT W2CRT (2)	BROWN (4)	A2CR (2)	W2CVT W2CRT (2)	U2CRT (2)	U2CRT (2)	U2CRT (2)	1-5/16					
YA2C2TC1045	2							1.31 [33]	.25 [6]	2.53 [64]																			
YA2C2TC1090	3							1.63 [41]		1.46 [37]																			
YA2C2NT14	1							1/4 [6]	.48 [12]	.62 [16]															-	.27 [7]	2.86 [73]	.31 [8]	.96 [24]
YA2C2NT1445	2																								1.43 [36]	2.66 [68]			
YA2C2NT1490	3																								1.76 [45]	1.58 [40]			
YA2C2TC14	1							1/4 [6]	.60 [15]	.62 [16]															-	.27 [7]	2.86 [73]	.31 [8]	.96 [24]
YA2C2TC1445	2																								1.43 [36]	2.66 [68]			
YA2C2TC1490	3																								1.76 [45]	1.58 [40]			
YA2C2TC14E2	1							1/4 [6]	.75 [19]	.75 [16]															-	.27 [7]	2.98 [76]	.31 [8]	1.09 [28]
YA2C2TC14E245	2																								1.43 [36]	2.78 [71]			
YA2C2TC14E290	3																								1.76 [45]	1.71 [43]			
YA2C2TC38E2	1							3/8 [10]	.75 [19]	.75 [16]															-	.40 [10]	3.17 [81]	.41 [10]	1.18 [30]
YA2C2TC38E245	2																								1.43 [36]	2.97 [75]			
YA2C2TC38E290	3																								1.76 [45]	1.90 [48]			
YA2C2TC516E2	1							5/16 [8]	.75 [19]	.75 [16]															-	.33 [8]	3.05 [77]	.34 [9]	1.12 [28]
YA2C2TC516E245	2																								1.43 [36]	2.84 [72]			
YA2C2TC516E290	3																								1.76 [45]	1.77 [45]			
YA2C2TC38E6	1							3/8 [10]	.88 [22]	.88 [16]															-	.40 [10]	3.30 [84]	.41 [10]	1.31 [33]
YA2C2TC38E645	2																								1.43 [36]	3.10 [79]			
YA2C2TC38E690	3	1.76 [45]	2.02 [51]																										
YA2C2TC38	1	3/8 [10]	1.00 [25]	1.00 [16]	-	.40 [10]	3.42 [87]	.41 [10]	1.43 [36]																				
YA2C2TC3845	2				1.43 [36]	3.22 [82]																							
YA2C2TC3890	3				1.76 [45]	2.14 [54]																							
YA2C2NTC38	1	3/8 [10]	1.75 [44]	1.75 [16]	-	.40 [10]	4.17 [106]	.41 [10]	2.18 [55]																				
YA2C2NTC3845	2				1.43 [36]	3.97 [101]																							
YA2C2NTC3890	3				1.76 [45]	2.90 [74]																							
YA2C2TC14E1	1	1/4 [6]	1.25 [32]	.60 [15]	1.00 [25]	.62 [16]	-	.27 [7]	3.24 [82]	.42 [11]	.11 [3]	1.34 [34]	10	BROWN	W2CVT W2CRT (2)	W2CVT W2CRT (2)	BROWN (4)	A2CR (2)	W2CVT W2CRT (2)	U2CRT (2)	U2CRT (2)	U2CRT (2)	1-5/16						
YA2C2TC14E145	2						1.43 [36]	3.03 [77]																					
YA2C2TC14E190	3						1.76 [45]	1.96 [50]																					

SEE SHEET 1 OF 20 FOR VIEWS AND NOTES

TO ORDER BURNDY® PRODUCTS CALL UNITED STATES 1-800-346-4175 (LONDONDERRY, NH) CANADA: 1-800-361-6975 (QUEBEC) 1-800-387-6487 (ALL OTHER PROVINCES) FOR PRODUCT INFO: http://www.burndy.com				HYLUG™ ITEM NO: N/A CAT. NO: YA2C-2TC & YA2C-2NT- DRAWN BY: J. MICHAUD 11/8/93 CHECKER: R. ROBICHEAU 1/10/94 DSN APPVL: C. PALAGI 1/12/94 MFG APPVL: N/A -- QA APPVL: A. LLOYD 1/24/94 MKT APPVL: G. GORDON 1/20/94 PROD FAM: CM&R COMPRESSION PROJECT #: -- DOCUMENT TYPE: Sales REL LEVEL: Released			
REV	DATE	DESCRIPTION	ECO	BY	C/H/K	DRAWING NO	REV
M	2017-10-31 00:00:00 EDT	YA2C2TC38E16 & YA2C2TC38E16 CATALOG ADDED TO SHEET 2 & 7 RLY	47886	BK	MB	SE208777	M

REV	DATE	DESCRIPTION	ECO	BY	C.H.K.
M	2017-10-31 00:00:00 EDT	YA8C2TC38E16 & YA1C2TC38E16 CATALOG ADDED TO SHEET 2 & 7 RLY	47886	BK	MB

D	CATALOG NO.	FIG. NO.	CONDUCTOR		BOLT SIZE	DIMENSIONS									INSTALLATION TOOLING (# CRIMPS)															
			CODE (AWG)	NAVY		B	C	E	H	K	L	N	O.D.	T REF.	Y MIN.	DIE INDEX	COLOR CODE	MECHANICAL			HYDRAULIC				DIELESS (# CRIMPS)	WIRE STRIP LENGTH				
																		MD7-34R MD6	OUR840	YIMRTC 6	BCT500 Y500CT	Y34A 8	Y750, Y35 Y39	Y46 4			Y45 3			
	YA1C2TC14	1	#1 AWG	75	1/4	1.38 [35]	.67 [17]	.62 [16]	-	.27 [7]	3.03 [77]	.31 [8]	.46 [11]	.10 [3]	.96 [24]	11 OR 375	GREEN	WICVT WICRT (2)	WICVT WICRT (2)	GREEN (4)	WICVT WICRT (2)	A4CAB AICR (2)	U4CABT UICRT (2)	U4CABT UICRT (2)	U4CABT UICRT (2)	MECHANICAL: MY29-11 (1) HYDRAULIC: Y644, Y644M Y644MBH, BAT644M Y1000 Y1000BH (1)	1-7/16			
	YA1C2TC1445	2				1.58 [40]	2.76 [70]	1.91 [49]	1.60 [41]	2.88 [73]	1.73 [44]	3.15 [80]	1.09 [28]																	
	YA1C2TC1490	3				1.91 [49]	1.60 [41]	1.73 [44]	3.15 [80]	1.09 [28]																				
	YA1C2TC14E2	1				1/4	1.38 [35]	.67 [17]	.62 [16]	-	.27 [7]	3.03 [77]	.31 [8]	.46 [11]	.10 [3]	.96 [24]	11 OR 375	GREEN	WICVT WICRT (2)	WICVT WICRT (2)	GREEN (4)	WICVT WICRT (2)	A4CAB AICR (2)	U4CABT UICRT (2)	U4CABT UICRT (2)		U4CABT UICRT (2)			
	YA1C2TC14E245	2					1.58 [40]	2.76 [70]	1.91 [49]	1.60 [41]	2.88 [73]	1.73 [44]	3.15 [80]	1.09 [28]																
	YA1C2TC14E290	3					1.91 [49]	1.60 [41]	1.73 [44]	3.15 [80]	1.09 [28]																			
	YA1C2TC14E1	1			1/4		1.38 [35]	.67 [17]	.62 [16]	-	.27 [7]	3.03 [77]	.31 [8]	.46 [11]	.10 [3]	.96 [24]	11 OR 375	GREEN	WICVT WICRT (2)	WICVT WICRT (2)	GREEN (4)	WICVT WICRT (2)	A4CAB AICR (2)	U4CABT UICRT (2)	U4CABT UICRT (2)		U4CABT UICRT (2)			
	YA1C2TC14E145	2					1.58 [40]	2.76 [70]	1.91 [49]	1.60 [41]	2.88 [73]	1.73 [44]	3.15 [80]	1.09 [28]																
	YA1C2TC14E190	3					1.91 [49]	1.60 [41]	1.73 [44]	3.15 [80]	1.09 [28]																			
	YA1C2TC38	1				3/8	1.38 [35]	.67 [17]	.62 [16]	-	.27 [7]	3.03 [77]	.31 [8]	.46 [11]	.10 [3]	.96 [24]	11 OR 375	GREEN	WICVT WICRT (2)	WICVT WICRT (2)	GREEN (4)	WICVT WICRT (2)	A4CAB AICR (2)	U4CABT UICRT (2)	U4CABT UICRT (2)		U4CABT UICRT (2)			
	YA1C2TC38E16	1					1.58 [40]	2.76 [70]	1.91 [49]	1.60 [41]	2.88 [73]	1.73 [44]	3.15 [80]	1.09 [28]																
	YA1C2TC3845	2					1.91 [49]	1.60 [41]	1.73 [44]	3.15 [80]	1.09 [28]																			
	YA1C2TC3890	3	1.91 [49]	1.60 [41]	1.73 [44]		3.15 [80]	1.09 [28]																						

C

B

A

SEE SHEET 1 OF 20 FOR VIEWS AND NOTES

TO ORDER BURNDY® PRODUCTS CALL UNITED STATES 1-800-346-4175 (LONDONDERRY, NH) CANADA: 1-800-361-6975 (QUEBEC) 1-800-387-6487 (ALL OTHER PROVINCES) FOR PRODUCT INFO: http://www.burndy.com	HYLUG™	
	ITEM NO:	N/A
	CAT. NO:	YA1C-2TC- (TABLE)
	DRAWN BY:	J. MICHAUD 11/8/93
	CHECKER:	R. ROBICHEAU 1/10/94
	DSN APPVL:	C. PALAGI 1/12/94
	MFG APPVL:	N/A --
	QA APPVL:	A. LLOYD 1/24/94
	MKT APPVL:	G. GORDON 1/20/94
	PROD FAM:	CM&R COMPRESSION
PROJECT #:	SIZE	DRAWING NO
DOCUMENT TYPE:	Sales	REV
REL LEVEL:	Released	SCALE: NTS



SE208777	M
SHEET 7 OF 20	

REV: PEO200

REV	DATE	DESCRIPTION	ECO	BY	C'K'K.
M	2017-10-31 00:00:00 EDT	YA8C2TC38E16 & YA1C2TC38E16 CATALOG ADDED TO SHEET 2 & 7 RLY	47886	BK	MB

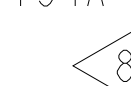
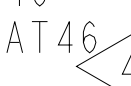
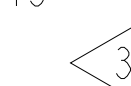
CATALOG NO.	FIG. NO.	CONDUCTOR		BOLT SIZE	DIMENSIONS									INSTALLATION TOOLING (# CRIMPS)																																									
		CODE (AWG)	NAVY 		B	C	E	H	K	L	N	O.D.	T REF.	Y MIN.	DIE INDEX	COLOR CODE	MECHANICAL		HYDRAULIC				DIELESS (# CRIMPS)	WIRE STRIP LENGTH																															
																	MD7-34R MD6	OUR840	Y500CT PAT600	Y34A 	Y750, Y35 Y39, PAT750	Y46 PAT46 			Y45 																														
YA252TC14	1	1/0 AWG	100	1/4	1.38 [32]	.75 [15]	.62 [16]	-	.27 [7]	3.05 [77]	.31 [8]	.51 [13]	.12 [3]	.96 [24]	12 OR 348	PINK	W25VT	W25VT	W25VT	A2CAB A25R (2)	U2CABT U25RT (2)	U2CABT U25RT (2)	U2CABT U25RT (2)	MECHANICAL: MY29-3 (2) MY29-11 (2) HYDRAULIC: MRC840 (4) Y644HS (1) Y81KFT (2) Y81KFTMBH (2) PAT81KFT-18V (2)	1-7/16																														
YA252TC1445	2							1.64 [42]		2.82 [72]							3.18 [81]	2.94 [75]	3.38 [86]	2.20 [56]	4.37 [111]	3.26 [83]	3.19 [81]																																
YA252TC1490	3							1.97 [50]		1.64 [42]							1.97 [50]	1.64 [42]	1.97 [50]	1.64 [42]	1.97 [50]	1.64 [42]	1.97 [50]																																
YA252TC14E2	1							1/4		1.00 [25]							.75 [19]	.40 [10]	3.49 [89]	.33 [8]	3.26 [83]	.34 [9]	3.43 [87]																																
YA252TC14E245	2																									1.64 [42]	2.94 [75]	3.38 [86]	2.20 [56]	4.37 [111]	3.26 [83]	3.19 [81]																							
YA252TC14E290	3																									1.97 [50]	1.64 [42]	1.97 [50]	1.64 [42]	1.97 [50]	1.64 [42]	1.97 [50]	1.64 [42]																						
YA252TC38	1							1/0 AWG		100							3/8	1.38 [32]	.75 [15]	1.00 [25]	-	.40 [10]	3.62 [92]			.41 [10]	.51 [13]	.12 [3]	1.43 [36]	12 OR 348	PINK	W25VT	W25VT	W25VT	A2CAB A25R (2)	U2CABT U25RT (2)	U2CABT U25RT (2)	U2CABT U25RT (2)	MECHANICAL: MY29-3 (2) MY29-11 (2) HYDRAULIC: MRC840 (4) Y644HS (1) Y81KFT (2) Y81KFTMBH (2) PAT81KFT-18V (2)	1-7/16															
YA252TC3845	2																				1.64 [42]		2.20 [56]									3.38 [86]	2.20 [56]	4.37 [111]	3.26 [83]	3.19 [81]																			
YA252TC3890	3																				1.97 [50]		1.64 [42]									1.97 [50]	1.64 [42]	1.97 [50]	1.64 [42]	1.97 [50]	1.64 [42]																		
YA252NTC38	1																				3/8		1.00 [25]									1.75 [44]	.40 [10]	3.49 [89]	.33 [8]	3.26 [83]	.34 [9]	3.43 [87]																	
YA252NTC3845	2																																								1.64 [42]	2.95 [75]	3.38 [86]	2.20 [56]	4.37 [111]	3.26 [83]	3.19 [81]								
YA252NTC3890	3																																								1.97 [50]	1.64 [42]	1.97 [50]	1.64 [42]	1.97 [50]	1.64 [42]	1.97 [50]	1.64 [42]							
YA252TC516	1																				1/0 AWG		100									5/16	1.38 [32]	.75 [15]	1.00 [25]	-	.33 [8]	3.49 [89]			.34 [9]	.51 [13]	.12 [3]	1.37 [35]	12 OR 348	PINK	W25VT	W25VT	W25VT	A2CAB A25R (2)	U2CABT U25RT (2)	U2CABT U25RT (2)	U2CABT U25RT (2)	MECHANICAL: MY29-3 (2) MY29-11 (2) HYDRAULIC: MRC840 (4) Y644HS (1) Y81KFT (2) Y81KFTMBH (2) PAT81KFT-18V (2)	1-7/16
YA252TC51645	2																																			1.64 [42]		2.08 [53]									3.38 [86]	2.20 [56]	4.37 [111]	3.26 [83]	3.19 [81]				
YA252TC51690	3																																			1.97 [50]		1.64 [42]									1.97 [50]	1.64 [42]	1.97 [50]	1.64 [42]	1.97 [50]	1.64 [42]			
YA252TC14E1	1	1/4	1.00 [25]	1.00 [25]	.27 [7]	3.49 [89]	.33 [8]		3.26 [83]		.34 [9]	3.43 [87]																																											
YA252TC14E145	2												1.64 [42]	2.01 [51]	3.38 [86]	2.20 [56]								4.37 [111]	3.26 [83]											3.19 [81]																			
YA252TC14E190	3												1.97 [50]	1.64 [42]	1.97 [50]	1.64 [42]								1.97 [50]	1.64 [42]											1.97 [50]		1.64 [42]																	

SEE SHEET 1 OF 20 FOR VIEWS & NOTES

TO ORDER BURNDY® PRODUCTS CALL UNITED STATES 1-800-346-4175 (LONDONDERRY, NH) CANADA: 1-800-361-6975 (QUEBEC) 1-800-387-6487 (ALL OTHER PROVINCES) FOR PRODUCT INFO: http://www.burndy.com	HYLUG™		
	ITEM NO:	N/A	
	CAT. NO:	YA-2TC- (TABLE)	
	DRAWN BY:	J. MICHARD 11/8/93	
	CHECKER:	R. ROBICHEAU 1/10/94	
	DSN APPVL:	C. PALAGI 1/12/94	
	MFG APPVL:	N/A --	
	QA APPVL:	A. LLOYD 1/24/94	
	MKT APPVL:	G. GORDON 1/20/94	
	PROD FAM:	CM&R COMPRESSION	
PROJECT #:	SIZE	DRAWING NO	REV
DOCUMENT TYPE:	Sales	SE208777	M
REL LEVEL:	Released	SHEET 8 OF 20	

REV: PEO200

REV	DATE	DESCRIPTION	ECO	BY	C'K
M	2017-10-31 00:00:00 EDT	YA8C2TC38E16 & YA1C2TC38E16 CATALOG ADDED TO SHEET 2 & 7 RLY	47886	BK	MB

CATALOG NO.	FIG. NO.	CONDUCTOR		BOLT SIZE	DIMENSIONS									INSTALLATION TOOLING (# CRIMPS)											
		CODE (AWG)	NAVY		B	C	E	H	K	L	N	O.D.	T REF.	Y MIN.	DIE INDEX	COLOR CODE	MECHANICAL		HYDRAULIC			DIELESS (# CRIMPS)	WIRE STRIP LENGTH		
																	MD7-34R MD6	OUR840	Y34A	BCT500 Y500CT	Y750, Y35 Y39			Y46	Y45
YA262TC14	1	2/0 AWG	125	1/4	1.50 [38]	.83 [21]	.62 [16]	-	.27 [7]	3.22 [82]	.31 [8]	.56 [14]	.12 [3]	.96 [24]	13	BLACK	W26VT W26RT (4)	W26VT W26RT (4)	A26R (2)	W26VT W26RT (4)	U26RT (2)	U26RT (2)	U26RT (2)	MECHANICAL: MY29-11 (1) HYDRAULIC: Y644, Y644M, Y644MBH, BAT644M, Y1000, Y1000BH (1)	1-9/16
YA262TC1445	2				1.83 [46]	2.14 [54]	2.94 [75]	1.66 [42]	3.34 [85]	1.09 [28]	W26VT W26RT (4)	W26VT W26RT (4)	A26R (2)	W26VT W26RT (4)	U26RT (2)	U26RT (2)	U26RT (2)								
YA262TC1490	3			1/4	1.83 [46]	2.14 [54]	2.94 [75]	1.66 [42]	3.34 [85]	1.09 [28]	W26VT W26RT (4)	W26VT W26RT (4)	A26R (2)	W26VT W26RT (4)	U26RT (2)	U26RT (2)	U26RT (2)								
YA262TC14E2	1				1.83 [46]	2.14 [54]	2.94 [75]	1.66 [42]	3.34 [85]	1.09 [28]	W26VT W26RT (4)	W26VT W26RT (4)	A26R (2)	W26VT W26RT (4)	U26RT (2)	U26RT (2)	U26RT (2)								
YA262TC14E245	2			1/4	1.83 [46]	2.14 [54]	2.94 [75]	1.66 [42]	3.34 [85]	1.09 [28]	W26VT W26RT (4)	W26VT W26RT (4)	A26R (2)	W26VT W26RT (4)	U26RT (2)	U26RT (2)	U26RT (2)								
YA262TC14E290	3				1.83 [46]	2.14 [54]	2.94 [75]	1.66 [42]	3.34 [85]	1.09 [28]	W26VT W26RT (4)	W26VT W26RT (4)	A26R (2)	W26VT W26RT (4)	U26RT (2)	U26RT (2)	U26RT (2)								
YA262TC38	1			3/8	1.00 [25]	1.83 [46]	2.14 [54]	3.78 [96]	.41 [10]	1.43 [36]	W26VT W26RT (4)	W26VT W26RT (4)	A26R (2)	W26VT W26RT (4)	U26RT (2)	U26RT (2)	U26RT (2)								
YA262TC3845	2				1.00 [25]	1.83 [46]	2.14 [54]	3.78 [96]	.41 [10]	1.43 [36]	W26VT W26RT (4)	W26VT W26RT (4)	A26R (2)	W26VT W26RT (4)	U26RT (2)	U26RT (2)	U26RT (2)								
YA262TC3890	3				1.00 [25]	1.83 [46]	2.14 [54]	3.78 [96]	.41 [10]	1.43 [36]	W26VT W26RT (4)	W26VT W26RT (4)	A26R (2)	W26VT W26RT (4)	U26RT (2)	U26RT (2)	U26RT (2)								
YA262TC14E1	1			1/4	1.50 [38]	.83 [21]	1.00 [25]	-	.27 [7]	3.59 [91]	.31 [8]	.56 [14]	.12 [3]	1.34 [34]	13	BLACK	W26VT W26RT (4)	W26VT W26RT (4)	A26R (2)	W26VT W26RT (4)	U26RT (2)	U26RT (2)	U26RT (2)		
YA262TC14E145	2	1.50 [38]	.83 [21]		1.00 [25]	-	.27 [7]	3.59 [91]	.31 [8]	.56 [14]	.12 [3]	1.34 [34]	13	BLACK	W26VT W26RT (4)	W26VT W26RT (4)	A26R (2)	W26VT W26RT (4)	U26RT (2)	U26RT (2)	U26RT (2)				
YA262TC14E190	3	1.50 [38]	.83 [21]		1.00 [25]	-	.27 [7]	3.59 [91]	.31 [8]	.56 [14]	.12 [3]	1.34 [34]	13	BLACK	W26VT W26RT (4)	W26VT W26RT (4)	A26R (2)	W26VT W26RT (4)	U26RT (2)	U26RT (2)	U26RT (2)				

SEE SHEET 1 OF 20 FOR VIEWS & NOTES



TO ORDER BURNDY® PRODUCTS CALL		HYLUG™	
UNITED STATES 1-800-346-4175 (LONDONDERRY, NH)		ITEM NO: N/A	CAT. NO: YA-2TC- (TABLE)
CANADA: 1-800-361-6975 (QUEBEC) 1-800-387-6487 (ALL OTHER PROVINCES)		DRAWN BY: J. MICHAUD 11/8/93	CHECKER: R. ROBICHEAU 1/10/94
FOR PRODUCT INFO: http://www.burndy.com		DSN APPVL: C. PALAGI 1/12/94	MFG APPVL: N/A --
		QA APPVL: A. LLOYD 1/24/94	MKT APPVL: G. GORDON 1/20/94
		PROD FAM: CM&R COMPRESSION	DRAWING NO: REV
		PROJECT #: --	SCALE: NTS
		DOCUMENT TYPE: Sales	SE208777
		REL LEVEL: Released	SHEET 9 OF 20

REV: PEO200

REV	DATE	DESCRIPTION	ECO	BY	CHK.
M	2017-10-31 00:00:00 EDT	YA8C2TC38E16 & YA1C2TC38E16 CATALOG ADDED TO SHEET 2 & 7 RLY	47886	BK	MB

D

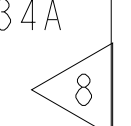
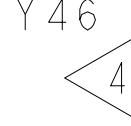
D

CATALOG NO.	FIG. NO.	CONDUCTOR		BOLT SIZE	DIMENSIONS									INSTALLATION TOOLING (# CRIMPS)											
		CODE (AWG)	NAVY 		B	C	E	H	K	L	N	O.D.	T REF.	Y MIN.	DIE INDEX	COLOR CODE	MECHANICAL		HYDRAULIC				DIELESS (# CRIMPS)	WIRE STRIP LENGTH	
																	MD7-34R MD6	OUR840	BCT500 Y500CT	Y34A 	Y750, Y35 Y39	Y46 			Y45 
YA272TC14E2	1	3/0 AWG	150	1/4	1.50 [38]	.90 [23]	.75 [19]	-	.27 [7]	3.38 [86]	.31 [8]	.62 [16]	.12 [3]	1.09 [28]	14	ORANGE	W27VT	W27VT	W27VT	A27R	U27RT	U27RT	U27RT	MECHANICAL: MY29-11 (1) HYDRAULIC: Y644, Y644M Y644MBH BAT644M Y1000 Y1000BH (1)	1-9/16
YA272TC14E245	2				1.86 [47]	1.82 [46]		3.10 [79]		1.82 [46]							W27RT (4)	W27RT (4)	W27RT (4)	A27R (2)	U27RT (2)	U27RT (2)	U27RT (2)		
YA272TC14E290	3				2.19 [56]	1.86 [47]		3.10 [79]		2.19 [56]							W27RT (4)	W27RT (4)	W27RT (4)	A27R (2)	U27RT (2)	U27RT (2)	U27RT (2)		
YA272TC38	1	3/0 AWG	150	1/4	1.50 [38]	.90 [23]	1.00 [25]	-	.40 [10]	3.82 [97]	.41 [10]	.62 [16]	.12 [3]	1.43 [36]	14	ORANGE	W27VT	W27VT	W27VT	A27R	U27RT	U27RT	U27RT	MECHANICAL: MY29-11 (1) HYDRAULIC: Y644, Y644M Y644MBH BAT644M Y1000 Y1000BH (1)	1-9/16
YA272TC3845	2				1.86 [47]	1.86 [47]		3.54 [90]		1.86 [47]							W27RT (4)	W27RT (4)	W27RT (4)	A27R (2)	U27RT (2)	U27RT (2)	U27RT (2)		
YA272TC3890	3				2.25 [57]	1.86 [47]		3.54 [90]		2.25 [57]							W27RT (4)	W27RT (4)	W27RT (4)	A27R (2)	U27RT (2)	U27RT (2)	U27RT (2)		

C

C

B

B

A

A

SEE SHEET 1 OF 20 FOR VIEWS & NOTES

TO ORDER BURNDY® PRODUCTS CALL UNITED STATES 1-800-346-4175 (LONDONDERRY, NH) CANADA: 1-800-361-6975 (QUEBEC) 1-800-387-6487 (ALL OTHER PROVINCES) FOR PRODUCT INFO: http://www.burndy.com	HYLUG™	
	ITEM NO:	N/A
	CAT. NO:	YA-2TC- (TABLE)
	DRAWN BY:	J. MICHAUD 11/8/93
	CHECKER:	R. ROBICHEAU 1/10/94
	DSN APPVL:	C. PALAGI 1/12/94
	MFG APPVL:	N/A --
	QA APPVL:	A. LLOYD 1/24/94
	MKT APPVL:	G. GORDON 1/20/94
	PROD FAM:	CM&R COMPRESSION
PROJECT #:	SIZE	SCALE: NTS
DOCUMENT TYPE:	Sales	DRAWING NO
REL LEVEL:	Released	REV
	D	SE208777
		M
		SHEET 10 OF 20



REV: PEO200

REV	DATE	DESCRIPTION	ECO	BY	C'K
M	2017-10-31 00:00:00 EDT	YA8C2TC38E16 & YA1C2TC38E16 CATALOG ADDED TO SHEET 2 & 7 RLY	47886	BK	MB

CATALOG NO.	FIG. NO.	CONDUCTOR		BOLT SIZE	DIMENSIONS										INSTALLATION TOOLING (# CRIMPS)										DIELESS (# CRIMPS)	WIRE STRIP LENGTH									
		CODE (AWG)	NAVY		B	C	E	H	K	L	N	O.D.	T REF.	Y MIN.	DIE INDEX	COLOR CODE	MECHANICAL		HYDRAULIC																
																	MD7-34R MD6	OUR840	BCT500 Y500CT	Y34A	Y750, Y35 Y39	Y46	Y45	Y48B			Y60B								
YA282TC14E2	1	4/0 AWG	200	1/4	1.62 [41]	1.02 [26]	.75 [19]	-	.27 [7]	3.55 [90]	.31 [8]	.69 [18]	.14 [4]	1.09 [28]	15	PURPLE	W28VT	W28VT	W28VT	A28R	U28RT	U28RT	U28RT	C28R	L28RT	MECHANICAL: MY29-11 (1) HYDRAULIC: Y644, Y644M Y644MBH BAT644M Y1000 Y1000BH (1)	1-11/16								
YA282TC14E245	2				2.04 [52]	3.25 [83]		2.38 [61]		1.86 [47]							3.99 [101]	3.69 [94]	2.30 [58]	4.74 [120]	4.44 [113]	3.05 [77]	W28RT (4)	W28RT (4)	W28RT (4)			A28R (2)	U28RT (2)	U28RT (2)	U28RT (2)	C28R (2)	L28RT (1)		
YA282TC14E290	3				2.38 [61]	1.86 [47]		3.99 [101]		3.69 [94]							2.30 [58]	4.74 [120]	4.44 [113]	3.05 [77]	W28VT	W28VT	W28VT	A28R	U28RT			U28RT	U28RT	C28R	L28RT				
YA282TC38	1	4/0 AWG	200	3/8	1.62 [41]	1.02 [26]	1.00 [25]	-	.40 [10]	3.99 [101]	.41 [10]	.69 [18]	.14 [4]	1.43 [36]	15	PURPLE	W28VT	W28VT	W28VT	A28R	U28RT	U28RT	U28RT	C28R	L28RT	MECHANICAL: MY29-11 (1) HYDRAULIC: Y644, Y644M Y644MBH BAT644M Y1000 Y1000BH (1)	1-11/16								
YA282TC3845	2							2.04 [52]		3.69 [94]							2.38 [61]	1.86 [47]	3.99 [101]	3.69 [94]	2.30 [58]	4.74 [120]	4.44 [113]	3.05 [77]	W28RT (4)			W28RT (4)	W28RT (4)	A28R (2)	U28RT (2)	U28RT (2)	U28RT (2)	C28R (2)	L28RT (1)
YA282TC3890	3							2.38 [61]		1.86 [47]							3.99 [101]	3.69 [94]	2.30 [58]	4.74 [120]	4.44 [113]	3.05 [77]	W28VT	W28VT	W28VT			A28R	U28RT	U28RT	U28RT	C28R	L28RT		
YA282NTC38	1	4/0 AWG	200	3/8	1.62 [41]	1.02 [26]	1.75 [44]	-	.40 [10]	4.74 [120]	.41 [10]	.69 [18]	.14 [4]	2.18 [55]	15	PURPLE	W28VT	W28VT	W28VT	A28R	U28RT	U28RT	U28RT	C28R	L28RT	MECHANICAL: MY29-11 (1) HYDRAULIC: Y644, Y644M Y644MBH BAT644M Y1000 Y1000BH (1)	1-11/16								
YA282NTC3845	2							2.04 [52]		4.44 [113]							2.38 [61]	1.86 [47]	4.74 [120]	4.44 [113]	3.05 [77]	W28RT (4)	W28RT (4)	W28RT (4)	A28R (2)			U28RT (2)	U28RT (2)	U28RT (2)	C28R (2)	L28RT (1)			
YA282NTC3890	3							2.38 [61]		3.05 [77]							1.86 [47]	1.86 [47]	4.74 [120]	4.44 [113]	3.05 [77]	W28VT	W28VT	W28VT	A28R			U28RT	U28RT	U28RT	C28R	L28RT			

SEE SHEET 1 OF 20 FOR VIEWS & NOTES

TO ORDER BURNDY® PRODUCTS CALL		HYLUG™	
UNITED STATES 1-800-346-4175 (LONDONDERRY, NH)		ITEM NO: N/A	CAT. NO: YA-2TC- (TABLE)
CANADA: 1-800-361-6975 (QUEBEC) 1-800-387-6487 (ALL OTHER PROVINCES)		DRAWN BY: J. MICHAUD 11/8/93	CHECKER: R. ROBICHEAU 1/10/94
FOR PRODUCT INFO: http://www.burndy.com		DSN APPVL: C. PALAGI 1/12/94	MFG APPVL: N/A --
		QA APPVL: A. LLOYD 1/24/94	MKT APPVL: G. GORDON 1/20/94
		PROD FAM: CM&R COMPRESSION	DRAWING NO: REV
		PROJECT #: --	SCALE: NTS
		DOCUMENT TYPE: Sales	SIZE: SE208777
		REL LEVEL: Released	SHEET 11 OF 20



REV: PEO200

REV	DATE	DESCRIPTION	ECO	BY	CHK.
M	2017-10-31 00:00:00 EDT	YA8C2TC38E16 & YA1C2TC38E16 CATALOG ADDED TO SHEET 2 & 7 RLY	47886	BK	MB

D

D

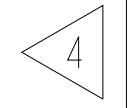
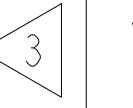
CATALOG NO.	FIG. NO.	CONDUCTOR		BOLT SIZE	DIMENSIONS										INSTALLATION TOOLING (# CRIMPS)													DIELESS (# CRIMPS)	WIRE STRIP LENGTH					
		SIZE	NAVY 5		B	C	E	H	K	L	N	O.D.	T REF.	Y MIN.	DIE INDEX	TYPE	COLOR CODE	MECHANICAL				HYDRAULIC												
																		MD7-34R	OUR840	MD6 MD7	MD6--R2	BCT500 Y500CT	Y34A 	Y34A Y34B Y34BH	Y750, Y35 Y39	Y46 	Y45 			Y48B	Y60B	Y60BHU		
YA292TC38	1	250 kcmil	250	3/8	1.10 [28]	1.00 [25]	-	.40 [10]	4.02 [102]	.41 [10]	.75 [19]	.16 [4]	1.43 [36]	16	--	YELLOW	W29VT W29RT (4)	X29RT (6)	--	--	W29VT W29RT (4) X29RT (6)	A29R (2)	--	U29RT (2)	U29RT (2)	U29RT (2)	C29R (2)	L29RT (1)	--	HYDRAULIC: Y644, Y644M Y644MBH BAT644M Y1000 Y1000BH (1)	1-11/16			
YA292TC3845	2						2.11 [54]		2.34 [59]								W29VT W29RT (4)	X29RT (6)	--	--	W29VT W29RT (4) X29RT (6)	A29R (2)	--	U29RT (2)	U29RT (2)	U29RT (2)	C29R (2)	L29RT (1)	--	MECHANICAL: MY29-3 (2) MY29-11(2)				
YA292TC3890	3						2.45 [62]		2.34 [59]								W29VT W29RT (4)	X29RT (6)	--	--	W29VT W29RT (4) X29RT (6)	A29R (2)	--	U29RT (2)	U29RT (2)	U29RT (2)	C29R (2)	L29RT (1)	--	HYDRAULIC: Y644M (1) BAT644M (1)				
YA292TC58E16	1	250 kcmil	250	5/8	1.11 [28]	1.75 [44]	--	.69 [18]	5.27 [134]	.66 [17]	.75 [19]	.16 [4]	2.42 [62]	16	YELLOW	NEST INDENTOR	--	--	--	--	B29D(2) A29D(2) Y34PR	U29D-1(2) Y34PR	U29D-1(2) Y34PR	U29D(1) Y34PR	C29D(1) Y34PR	--	--	MECHANICAL: MY29-3 (2) MY29-11(2)	1-11/16					
YA292TC58E16	1			5/8	1.11 [28]	1.75 [44]	--	.69 [18]	5.27 [134]	.66 [17]						.75 [19]	.16 [4]	2.42 [62]	16	YELLOW	NEST INDENTOR	--	--	--	--	B29D(2) A29D(2) Y34PR	U29D-1(2) Y34PR	U29D-1(2) Y34PR		U29D(1) Y34PR	C29D(1) Y34PR	--	--	MECHANICAL: MY29-3 (2) MY29-11(2)

C

C

B

B

A

A

REV: PEG200

SEE SHEET 1 OF 20 FOR VIEWS & NOTES

TO ORDER BURNDY® PRODUCTS CALL UNITED STATES 1-800-346-4175 (LONDONDERRY, NH) CANADA: 1-800-361-6975 (QUEBEC) 1-800-387-6487 (ALL OTHER PROVINCES) FOR PRODUCT INFO: http://www.burndy.com	HYLUG™			
	ITEM NO:	N/A		
	CAT. NO:	YA-2TC- (TABLE)		
	DRAWN BY:	J. MICHAUD	11/8/93	
	CHECKER:	R. ROBICHEAU	1/10/94	
	DSN APPVL:	C. PALAGI	1/12/94	
	MFG APPVL:	N/A	--	
	QA APPVL:	A. LLOYD	1/24/94	
	MKT APPVL:	G. GORDON	1/10/94	
	PROD FAM:	CM&R COMPRESSION	DRAWING NO	REV
PROJECT #:	--	SIZE	SE208777	
DOCUMENT TYPE:	Sales		M	
REL LEVEL:	Released	D	SHEET 12 OF 20	

REV	DATE	DESCRIPTION	ECO	BY	C'K.
M	2017-10-31 00:00:00 EDT	YA8C2TC38E16 & YA1C2TC38E16 CATALOG ADDED TO SHEET 2 & 7 RLY	47886	BK	MB





CATALOG NO.	FIG. NO.	CONDUCTOR		BOLT SIZE	DIMENSIONS										INSTALLATION TOOLING (# CRIMPS)										DIELESS (# CRIMPS)	WIRE STRIP LENGTH													
		SOZE	NAVY		B	C	E	H	K	L	N	O.D.	T REF.	Y MIN.	DIE INDEX	COLOR CODE	MECHANICAL		HYDRAULIC																				
YA302TC38	1								-																														
YA302TC3845	2	300kcmil	300	3/8	2.00 [51]	1.20 [30]	1.00 [25]	2.46 [62]	.40 [10]	4.07 [103]	.41 [10]	.81 [21]	.16 [4]	1.43 [36]	17 OR 298	WHITE	MD7-34R W30RT (4)	BCT500 Y500CT W30RT (4)	Y34A A28R A30R (4)	Y750,Y35 Y39 U28ART U30RT (4)	Y46 U28ART U30RT (4)	Y45 U28ART U30RT (4)	Y48B C28AR (4) C30R (1)	Y486RB F28AR (4)	Y60B L30RT (1)	HYDRAULIC: Y644, Y644M Y644MBH BAT644M Y1000 Y1000BH (1)	2-1/16												
YA302TC3890	3							2.89 [73]		2.37 [60]																													

SEE SHEET 1 OF 20 FOR VIEWS & NOTES

TO ORDER BURNDY® PRODUCTS CALL UNITED STATES 1-800-346-4175 (LONDONDERRY, NH) CANADA: 1-800-361-6975 (QUEBEC) 1-800-387-6487 (ALL OTHER PROVINCES) FOR PRODUCT INFO: http://www.burndy.com		HYLUG™	
		ITEM NO: N/A	CAT. NO: YA-2TC- (TABLE)
DRAWN BY: J.MICHAUD 11/8/93		CHECKER: R.ROBICHEAU 1/10/94	
DSN APPVL: C.PALAGI 1/12/94		MFG APPVL: N/A --	
QA APPVL: A.LLOYD 1/24/94		MKT APPVL: G.GORDON 1/20/94	
PROD FAM: CM&R COMPRESSION	DRAWING NO	SCALE: NTS	REV
PROJECT #: --	SIZE	SE208777	M
DOCUMENT TYPE: Sales	D	SHEET 13 OF 20	
REL LEVEL: Released			

REV: PE0200

REV	DATE	DESCRIPTION	ECO	BY	CHK.
M	2017-10-31 00:00:00 EDT	YA8C2TC38E16 & YA1C2TC38E16 CATALOG ADDED TO SHEET 2 & 7 RLY	47886	BK	MB

CATALOG NO.	FIG. NO.	CONDUCTOR		BOLT SIZE	DIMENSIONS									INSTALLATION TOOLING (# CRIMPS)										DIELESS (#CRIMPS)	WIRE STRIP LENGTH									
		SIZE	NAVY 		B	C	E	H	K	L	N	O.D.	T REF.	Y MIN.	DIE INDEX	COLOR CODE	MECHANICAL		HYDRAULIC															
																	MD7-34R	BCT500 Y500CT	Y34A 	Y750, Y35 Y39	Y46 	Y45 	Y48B			Y486RB	Y60B							
YA312TC14E2	1	350 kcmil	350	1/4	2.00 [51]	1.29 [33]	-	4.05 [103]	.31 [8]	.88 [22]	.18 [5]	1.09 [28]	18 OR 324	RED	W31VT W31RT (4)	W31VT W31RT (4)	A29AR A31R (4)	U29ART U31RT (4)	U29ART U31RT (4)	U29ART U31RT (4)	C29AR C31R (1)	F29AR F31R (1)	L29ART L31RT (1)	HYDRAULIC: Y644, Y644MB BAT644M Y1000 Y1000BH (1)	2-1/16									
YA312TC14E245	2						2.54 [65]	.27 [7]					3.68 [94]	↑	↑	↑	↑	↑	↑	↑	↑	↑	↑		↑	↑	↑	↑	↑	↑	↑	↑	↑	
YA312TC14E290	3						2.96 [75]	1.97 [50]					↑	↑	↑	↑	↑	↑	↑	↑	↑	↑	↑		↑	↑	↑	↑	↑	↑	↑	↑	↑	
YA312TC38	1	350 kcmil	350	3/8	2.00 [51]	1.29 [33]	-	4.49 [114]	.41 [10]	.88 [22]	.18 [5]	1.43 [36]	18 OR 324	RED	W31VT W31RT (4)	W31VT W31RT (4)	A29AR A31R (4)	U29ART U31RT (4)	U29ART U31RT (4)	U29ART U31RT (4)	C29AR C31R (1)	F29AR F31R (1)	L29ART L31RT (1)		HYDRAULIC: Y644, Y644MB BAT644M Y1000 Y1000BH (1)	2-1/16								
YA312TC3845	2						2.54 [65]	.40 [10]					4.12 [105]	↓	↓	↓	↓	↓	↓	↓	↓	↓	↓			↓	↓	↓	↓	↓	↓	↓	↓	↓
YA312TC3890	3						2.96 [75]	2.41 [61]					↓	↓	↓	↓	↓	↓	↓	↓	↓	↓	↓			↓	↓	↓	↓	↓	↓	↓	↓	↓

SEE SHEET 1 OF 20 FOR VIEWS & NOTES

TO ORDER BURNDY® PRODUCTS CALL UNITED STATES 1-800-346-4175 (LONDONDERRY, NH) CANADA: 1-800-361-6975 (QUEBEC) 1-800-387-6487 (ALL OTHER PROVINCES) FOR PRODUCT INFO: http://www.burndy.com		HYLUG™	
		ITEM NO: N/A	CAT. NO: YA-2TC- (TABLE)
DRAWN BY: J. MICHAUD 11/8/93		CHECKER: R. ROBICHEAU 1/10/94	
DSN APPVL: C. PALAGI 1/12/94		MFG APPVL: N/A --	
QA APPVL: A. LLOYD 1/24/94		MKT APPVL: G. GORDON 1/20/94	
PROD FAM: CM&R COMPRESSION		DRAWING NO: REV	
PROJECT #: --		SCALE: NTS	
DOCUMENT TYPE: Sales		SIZE: SE208777	
REL LEVEL: Released		SHEET 14 OF 20	



REV: PEO200

REV	DATE	DESCRIPTION	ECO	BY	C'K
M	2017-10-31 00:00:00 EDT	YA8C2TC38E16 & YA1C2TC38E16 CATALOG ADDED TO SHEET 2 & 7 RLY	47886	BK	MB

D

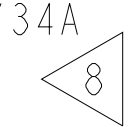
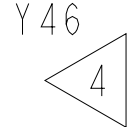
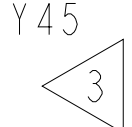
CATALOG NO.	FIG. NO.	CONDUCTOR		BOLT SIZE	DIMENSIONS									INSTALLATION TOOLING (# CRIMPS)										DIELESS (# CRIMPS)	WIRE STRIP LENGTH		
		SIZE	NAVY 		B	C	E	H	K	L	N	O.D.	T REF.	Y MIN.	MECHANICAL		HYDRAULIC										
															MD7-34R	BCT500 Y500CT	Y34A 	Y750, Y35 Y39	Y46 	Y45 	Y48B	Y486RB	Y60B				
YA322TC38	1																										
YA322TC3845	2	400 kcmil	400	3/8	2.12 [54]	1.40 [36]	1.00 [25]	2.72 [69]	.40 [10]	4.28 [109]	.41 [10]	.95 [24]	.19 [5]	1.43 [36]	19 OR 470	BLUE	W32RT (4)	W32RT (4)	A30AR A32R (4)	U30ART U32RT (4)	U30ART U32RT (4)	U30ART U32RT (4)	C30AR C32R (1)	F30AR (1)	L30ART L32RT (1)	HYDRAULIC: Y644, Y644M Y644MBH Y1000 Y1000BH (1)	2-3/16
YA322TC3890	3							3.16 [80]		2.46 [62]																	

C

B

A

SEE SHEET 1 OF 20 FOR VIEWS & NOTES

TO ORDER BURNDY® PRODUCTS CALL UNITED STATES 1-800-346-4175 (LONDONDERRY, NH) CANADA: 1-800-361-6975 (QUEBEC) 1-800-387-6487 (ALL OTHER PROVINCES) FOR PRODUCT INFO: http://www.burndy.com	HYLUG™		
	ITEM NO:	N/A	
	CAT. NO:	YA-2TC- (TABLE)	
	DRAWN BY:	J. MICHAUD 11/8/93	
	CHECKER:	R. ROBICHEAU 1/10/94	
	DSN APPVL:	C. PALAGI 1/12/94	
	MFG APPVL:	N/A --	
	QA APPVL:	A. LLOYD 1/24/94	
	MKT APPVL:	G. GORDON 1/20/94	
	PROD FAM:	CM&R COMPRESSION	
PROJECT #:	SIZE	DRAWING NO	REV
DOCUMENT TYPE:	Sales	SE208777	M
REL LEVEL:	Released	D	SHEET 15 OF 20



REV: PEO200

D

C

B

A

D	CATALOG NO.	FIG. NO.	CONDUCTOR SIZE	BOLT SIZE	DIMENSIONS									INSTALLATION TOOLING (# CRIMPS)											WIRE STRIP LENGTH		
					B	C	E	H	K	L	N	O.D.	T REF.	Y MIN.	DIE INDEX	COLOR CODE	MECHANICAL			HYDRAULIC						DIELESS (# CRIMPS)	
																	MD7-34R	BCT500 Y500CT	Y34A 8	Y750,Y35 Y39	Y46 4	Y45 3	Y48B	Y486RB			Y60B
YA342TC14E2	1	500 kcmil	1/4	2.25 [57]	1.55 [39]	-	4.46 [113]	.27 [7]	.31 [8]	1.06 [27]	.23 [6]	1.09 [28]	20 OR 299	BROWN	W34RT (4)	W34RT (4)	A34R (4)	U31ART (2) U34RT (4)	U31ART (2) U34RT (4)	U31ART (2) U34RT (4)	C31AR (1) C34R (2)	F31AR (1)	L34RT (2)	HYDRAULIC: Y644, Y644M Y644MBH BAT644M Y1000 Y1000BH (1)	2-5/16		
YA342TC14E245	2					.75 [19]	2.96 [75]						4.07 [104]	2.09 [53]	20 OR 299	BROWN	W34RT (4)	W34RT (4)	A34R (4)	U31ART (2) U34RT (4)	U31ART (2) U34RT (4)	U31ART (2) U34RT (4)	C31AR (1) C34R (2)		F31AR (1)	L34RT (2)	2-5/16
YA342TC14E290	3					3.43 [88]	2.09 [53]						20 OR 299	BROWN	W34RT (4)	W34RT (4)	A34R (4)	U31ART (2) U34RT (4)	U31ART (2) U34RT (4)	U31ART (2) U34RT (4)	C31AR (1) C34R (2)	F31AR (1)	L34RT (2)		2-5/16		
YA342TC38	1	500 kcmil	3/8	2.25 [57]	1.55 [39]	-	4.90 [124]	.40 [10]	.41 [10]	1.06 [27]	.23 [6]	1.43 [36]	20 OR 299	BROWN	W34RT (4)	W34RT (4)	A34R (4)	U31ART (2) U34RT (4)	U31ART (2) U34RT (4)	U31ART (2) U34RT (4)	C31AR (1) C34R (2)	F31AR (1)	L34RT (2)	HYDRAULIC: Y644, Y644M Y644MBH BAT644M Y1000 Y1000BH (1)	2-5/16		
YA342TC3845	2					1.00 [25]	2.96 [75]						4.51 [115]	2.53 [65]	20 OR 299	BROWN	W34RT (4)	W34RT (4)	A34R (4)	U31ART (2) U34RT (4)	U31ART (2) U34RT (4)	U31ART (2) U34RT (4)	C31AR (1) C34R (2)		F31AR (1)	L34RT (2)	2-5/16
YA342TC3890	3					3.43 [88]	2.53 [65]						20 OR 299	BROWN	W34RT (4)	W34RT (4)	A34R (4)	U31ART (2) U34RT (4)	U31ART (2) U34RT (4)	U31ART (2) U34RT (4)	C31AR (1) C34R (2)	F31AR (1)	L34RT (2)		2-5/16		
YA342G66	1	500 kcmil	1/2	2.00 [51]	-	.56 [14]	6.33 [161]	.63 [16]	2.65 [67]	20 OR 299	BROWN	W34RT (4)	W34RT (4)	A34R (4)	U31ART (2) U34RT (4)	U31ART (2) U34RT (4)	U31ART (2) U34RT (4)	C31AR (1) C34R (2)	F31AR (1)	L34RT (2)	2-5/16						

SEE SHEET 1 OF 20 FOR VIEWS & NOTES

TO ORDER BURNDY® PRODUCTS CALL		HYLUG™	
UNITED STATES 1-800-346-4175 (LONDONDERRY, NH)		ITEM NO:	N/A
CANADA: 1-800-361-6975 (QUEBEC) 1-800-387-6487 (ALL OTHER PROVINCES)		CAT. NO:	YA-2TC- (TABLE)
FOR PRODUCT INFO: http://www.burndy.com		DRAWN BY:	J. MICHAUD 11/8/93
		CHECKER:	R. ROBICHEAU 1/10/94
		DSN APPVL:	C. PALAGI 1/12/94
		MFG APPVL:	N/A --
		QA APPVL:	A. LLOYD 1/24/94
		MKT APPVL:	G. GORDON 1/20/94
		PROD FAM:	CM&R COMPRESSION
		PROJECT #:	--
		DOCUMENT TYPE:	Sales
		REL LEVEL:	Released
		SCALE:	NTS
		DRAWING NO:	SE208777
		REV:	M
		SHEET:	16 OF 20

REV: PEO200

REV	DATE	DESCRIPTION	ECO	BY	CHK.
M	2017-10-31 00:00:00 EDT	YA8C2TC38E16 & YA1C2TC38E16 CATALOG ADDED TO SHEET 2 & 7 RLY	47886	BK	MB

CATALOG NO.	FIG. NO.	CONDUCTOR SIZE (CODE)	BOLT SIZE	DIMENSIONS										INSTALLATION TOOLING (# CRIMPS)													
				B	C	E	H	K	L	N	O.D.	T REF.	Y MIN.	DIE INDEX	COLOR CODE	HYDRAULIC					DIELESS (# CRIMPS)	WIRE STRIP LENGTH					
																Y750, Y35 Y39	Y46	Y45	Y48B	Y60B							
YA362TC38	1	600 kcmil	3/8				-		5.59 [142]								22 OR 472	GREEN	U36RT U32ART (4)	U36RT U32ART (4)	U36RT U32ART (4)	C36R C32AR (2)	L36RT L32ART (2)	HYDRAULIC: Y644, Y644M Y644MBH, BAT644M Y1000 Y1000BH (1)	2-3/4		
YA362TC3845	2			2.69 [68]	1.74 [44]	1.00 [25]	3.44 [87]	.40 [10]	5.17 [131]	.50 [13]	1.19 [30]	.26 [7]	1.53 [39]														
YA362TC3890	3			4.04 [103]			2.81 [71]																				
YA382TC38	1	700 kcmil	3/8				-		5.76 [146]								400	PINK	U38RT (4)	U38RT (4)	U38RT (4)	-	L38RT (2)	HYDRAULIC: Y644M (1) BAT644M (1)	2-7/8		
YA382TC3845	2			2.81 [71]	1.84 [47]	1.00 [25]	3.60 [91]	.40 [10]	5.29 [134]	.50 [13]	1.25 [32]	.27 [7]	1.53 [39]														
YA382TC3890	3			4.21 [107]			2.84 [72]																				

SEE SHEET 1 OF 20 FOR VIEWS & NOTES

TO ORDER BURNDY® PRODUCTS CALL		HYLUG™	
UNITED STATES 1-800-346-4175 (LONDONDERRY, NH)		ITEM NO: N/A	
CANADA: 1-800-361-6975 (QUEBEC) 1-800-387-6487 (ALL OTHER PROVINCES)		CAT. NO: YA-2TC- (TABLE)	
FOR PRODUCT INFO: http://www.burndy.com		DRAWN BY: J. MICHAUD 11/8/93	
		CHECKER: R. ROBICHEAU 1/10/94	
		DSN APPVL: C. PALAGI 1/12/94	
		MFG APPVL: N/A --	
		QA APPVL: A. LLOYD 1/24/94	
		MKT APPVL: G. GORDON 1/20/94	
		SCALE: NTS	
		PROD. FAM: CM&R COMPRESSION	
		DRAWING NO	
		REV	
		PROJECT #: --	
		SIZE	
		DOCUMENT TYPE: Sales	
		REL LEVEL: Released	
		SE208777	
		SHEET 17 OF 20	
		M	

REV: PE0200

REV	DATE	DESCRIPTION	ECO	BY	C'K
M	2017-10-31 00:00:00 EDT	YA8C2TC38E16 & YA1C2TC38E16 CATALOG ADDED TO SHEET 2 & 7 RLY	47886	BK	MB

D

D

C

C

B

B

A

A

CATALOG NO.	FIG. NO.	CONDUCTOR SIZE	BOLT SIZE	DIMENSIONS										INSTALLATION TOOLING (# CRIMPS)										
				B	C	E	H	K	L	N	O.D.	T REF.	Y MIN.	DIE INDEX	COLOR CODE	HYDRAULIC						DIELESS (# CRIMPS)	WIRE STRIP LENGTH	
																Y750, Y35 Y39	Y46	Y45	Y48B	Y486RB	Y60B			
YA392NT38	1	750 kcmil	3/8	2.88 [73]	1.63 [41]	1.00 [25]	-	.40 [10]	5.87 [149]	.50 [13]	1.30 [33]	.27 [7]	1.53 [39]	24	BLACK	U39RT (4)	U39RT (4)	U39RT (4)	C39R (2)	F39R (2)	L39RT (2)	HYDRAULIC: Y644, Y644M Y644MBH, BAT644M Y1000 Y1000BH (1)	2-15/16	
YA392NT3845	2			1.63 [41]	3.71 [94]		5.38 [137]	24	BLACK	U39RT (4)	U39RT (4)	U39RT (4)	C39R (2)	F39R (2)	L39RT (2)	2-15/16								
YA392NT3890	3			1.63 [41]	4.32 [110]		2.87 [73]	24	BLACK	U39RT (4)	U39RT (4)	U39RT (4)	C39R (2)	F39R (2)	L39RT (2)	2-15/16								
YA392TC38	1	750 kcmil	3/8	2.88 [73]	1.91 [49]	1.00 [25]	-	.40 [10]	5.87 [149]	.50 [13]	1.30 [33]	.27 [7]	1.53 [39]	24	BLACK	U39RT (4)	U39RT (4)	U39RT (4)	C39R (2)	F39R (2)	L39RT (2)		HYDRAULIC: Y644, Y644M Y644MBH, BAT644M Y1000 Y1000BH (1)	2-15/16
YA392TC3845	2			1.91 [49]	3.71 [94]		5.38 [137]	24	BLACK	U39RT (4)	U39RT (4)	U39RT (4)	C39R (2)	F39R (2)	L39RT (2)	2-15/16								
YA392TC3890	3			1.91 [49]	4.32 [110]		2.87 [73]	24	BLACK	U39RT (4)	U39RT (4)	U39RT (4)	C39R (2)	F39R (2)	L39RT (2)	2-15/16								

SEE SHEET 1 OF 20 FOR VIEWS & NOTES

TO ORDER BURNDY® PRODUCTS CALL		HYLUG™	
UNITED STATES 1-800-346-4175 (LONDONDERRY, NH)		ITEM NO: N/A	
CANADA: 1-800-361-6975 (QUEBEC) 1-800-387-6487 (ALL OTHER PROVINCES)		CAT. NO: YA- 2TC- (TABLE)	
FOR PRODUCT INFO: http://www.burndy.com		DRAWN BY: J. MICHAUD 11/8/93	
		CHECKER: R. ROBICHEAU 1/10/94	
		DSN APPVL: C. PALAGI 1/12/94	
		MFG APPVL: N/A --	
		QA APPVL: A. LLOYD 1/24/94	
		MKT APPVL: G. GORDON 1/20/94	
		SCALE: NTS	
		PROD. FAM: CM&R COMPRESSION	
		DRAWING NO	
		REV	
		PROJECT #: --	
		SIZE	
		DOCUMENT TYPE: Sales	
		REL LEVEL: Released	
		SE208777	
		M	
		SHEET 18 OF 20	



REV: PEO200

REV	DATE	DESCRIPTION	ECO	BY	C'K
M	2017-10-31 00:00:00 EDT	YA8C2TC38E16 & YA1C2TC38E16 CATALOG ADDED TO SHEET 2 & 7 RLY	47886	BK	MB

D

D

CATALOG NO.	FIG. NO.	CONDUCTOR SIZE	BOLT SIZE	DIMENSIONS										INSTALLATION TOOLING (# CRIMPS)								
				B	C	E	H	K	L	N	O.D.	T REF.	Y MIN.	DIE INDEX	COLOR CODE	HYDRAULIC				DIELESS (# CRIMPS)	WIRE STRIP LENGTH	
																Y46	Y45	Y48B	Y60B			
YA402TC38	1																					
YA402TC3845	2	800 kcmil	3/8	2.94 [75]	1.98 [50]	1.00 [25]	3.81 [97]	.40 [10]	5.94 [151]	5.49 [139]	.50 [13]	1.35 [34]	.30 [8]	1.53 [39]	25	ORANGE	P40RT (4)	S40RT (4)	C40R (2)	L40RT (2)	HYDRAULIC: Y644, Y644M Y644MBH BAT644M, Y1000 Y1000BH (1)	3-1/16
YA402TC3890	3						4.46 [113]		2.91 [74]													

C

C

B

B

A

A

SEE SHEET 1 OF 20 FOR VIEWS & NOTES

TO ORDER BURNDY® PRODUCTS CALL UNITED STATES 1-800-346-4175 (LONDONDERRY, NH) CANADA: 1-800-361-6975 (QUEBEC) 1-800-387-6487 (ALL OTHER PROVINCES) FOR PRODUCT INFO: http://www.burndy.com	HYLUG™	
	ITEM NO: N/A	
	CAT. NO: YA- 2TC- (TABLE)	
	DRAWN BY: J. MICHAUD 11/8/93	
	CHECKER: R. ROBICHEAU 1/10/94	
	DSN APPVL: C. PALAGI 1/12/94	
	MFG APPVL: N/A --	
	QA APPVL: A. LLOYD 1/24/94	
MKT APPVL: G. GORDON 1/20/94		SCALE: NTS
PROD FAM: CM&R COMPRESSION	DRAWING NO	REV
PROJECT #: --	SIZE	SE208777
DOCUMENT TYPE: Sales	D	M
REL LEVEL: Released		SHEET 19 OF 20

REV: PEO200

REV	DATE	DESCRIPTION	ECO	BY	CHK.
M	2017-10-31 00:00:00 EDT	YA8C2TC38E16 & YA1C2TC38E16 CATALOG ADDED TO SHEET 2 & 7 RLY	47886	BK	MB

D

D

CATALOG NO.	FIG. NO.	CONDUCTOR SIZE	BOLT SIZE	DIMENSIONS										INSTALLATION TOOLING (# CRIMPS)												
				B	C	E	H	K	L	N	O.D.	T REF.	Y MIN.	DIE INDEX	COLOR CODE	HYDRAULIC					DIELESS (# CRIMPS)	WIRE STRIP LENGTH				
																Y46	Y45	Y48B	Y486RB	Y60B						
YA442TC38	1						-		6.14 [156]																	
YA442TC3845	2	1000 kcmil	3/8	3.00 [76]	2.19 [56]	1.00 [25]	4.06 [103]	.40 [10]	5.71 [145]	.50 [13]	1.50 [38]	.33 [8]	1.53 [39]	27	WHITE	S44RT (4)	P44RT (4)	C44R (2)	F44R (2)	L44RT (2)	HYDRAULIC: Y644, Y644M BAT644M, Y644MBH Y1000 Y1000BH (1)	3-1/16				
YA442TC3890	3						4.70 [119]		3.02 [77]																	

C

C

B

B

A

A

SEE SHEET 1 OF 20 FOR VIEWS & NOTES

TO ORDER BURNDY® PRODUCTS CALL UNITED STATES 1-800-346-4175 (LONDONDERRY, NH) CANADA: 1-800-361-6975 (QUEBEC) 1-800-387-6487 (ALL OTHER PROVINCES) FOR PRODUCT INFO: http://www.burndy.com	HYLUG™	
	ITEM NO:	N/A
	CAT. NO:	YA- 2TC- (TABLE)
	DRAWN BY:	J. MICHAUD 11/8/93
	CHECKER:	R. ROBICHEAU 1/10/94
	DSN APPVL:	C. PALAGI 1/12/94
	MFG APPVL:	N/A --
	QA APPVL:	A. LLOYD 1/24/94
	MKT APPVL:	G. GORDON 1/20/94
	PROD FAM:	CM&R COMPRESSION
PROJECT #:	--	
DOCUMENT TYPE:	Sales	
REL LEVEL:	Released	
DRAWING NO	SE208777	
SCALE:	NTS	
REV	M	
SHEET	20 OF 20	



REV: PEO200