

CONNECTOR SIZE	TOLERANCES					
	B	C	K DIA.	L	N	O.D.
-10C	±.03	±.04	±.02	±.06	±.03	±.01
8C - 25	±.06	±.04	±.02	±.09	±.03	±.01
26 - 34	±.08	±.04	±.02	±.12	±.03	±.01
35 AND UP	±.09	±.06	±.02	±.15	±.06	±.01

REV	DATE	DESCRIPTION	ECO	BY	C'H'K.
M	05/05/2017 16:12:00 PM	YA32LN516FX135 ADDED AS PER MU	46658	SM	MB

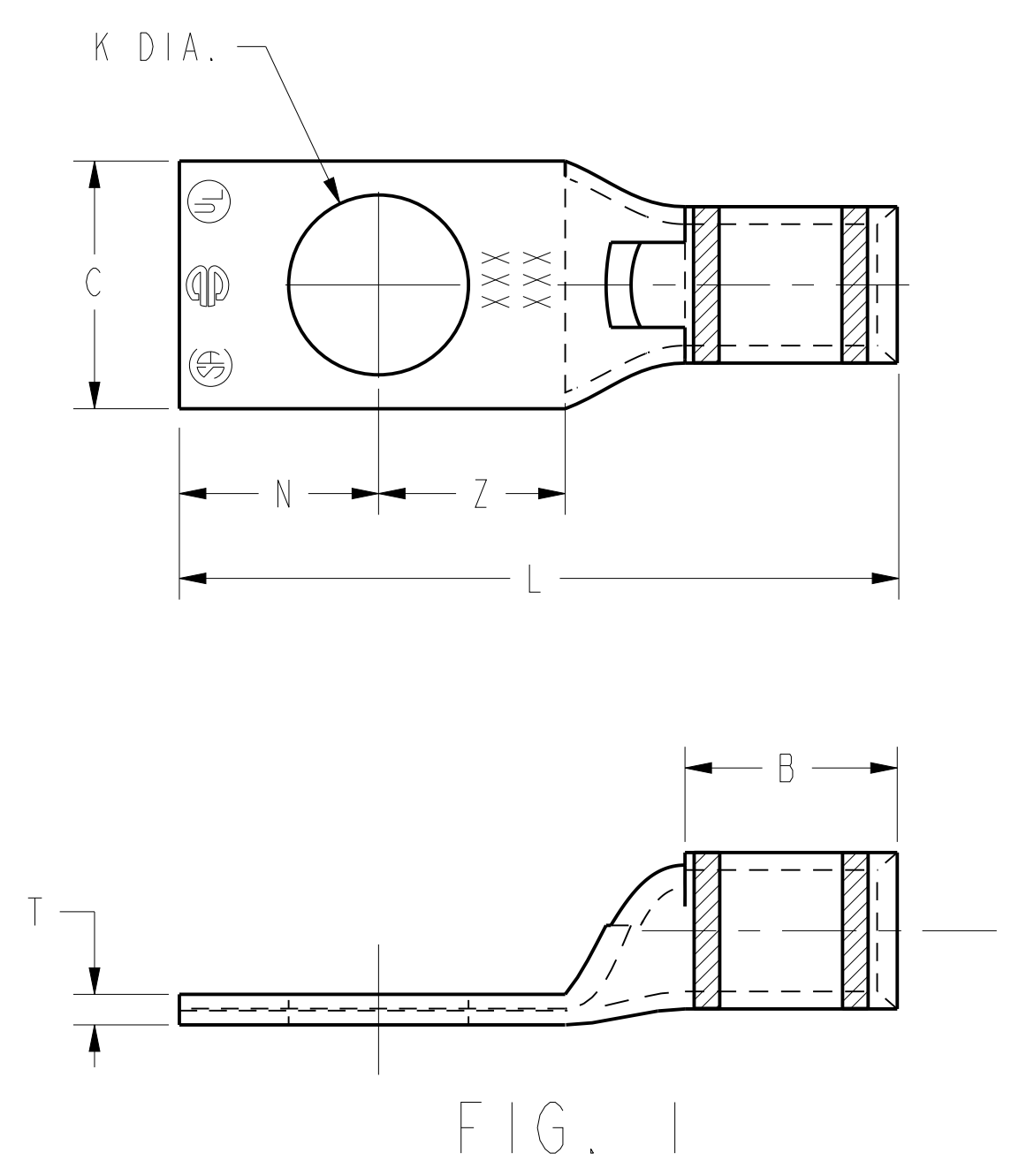

FIG. 1

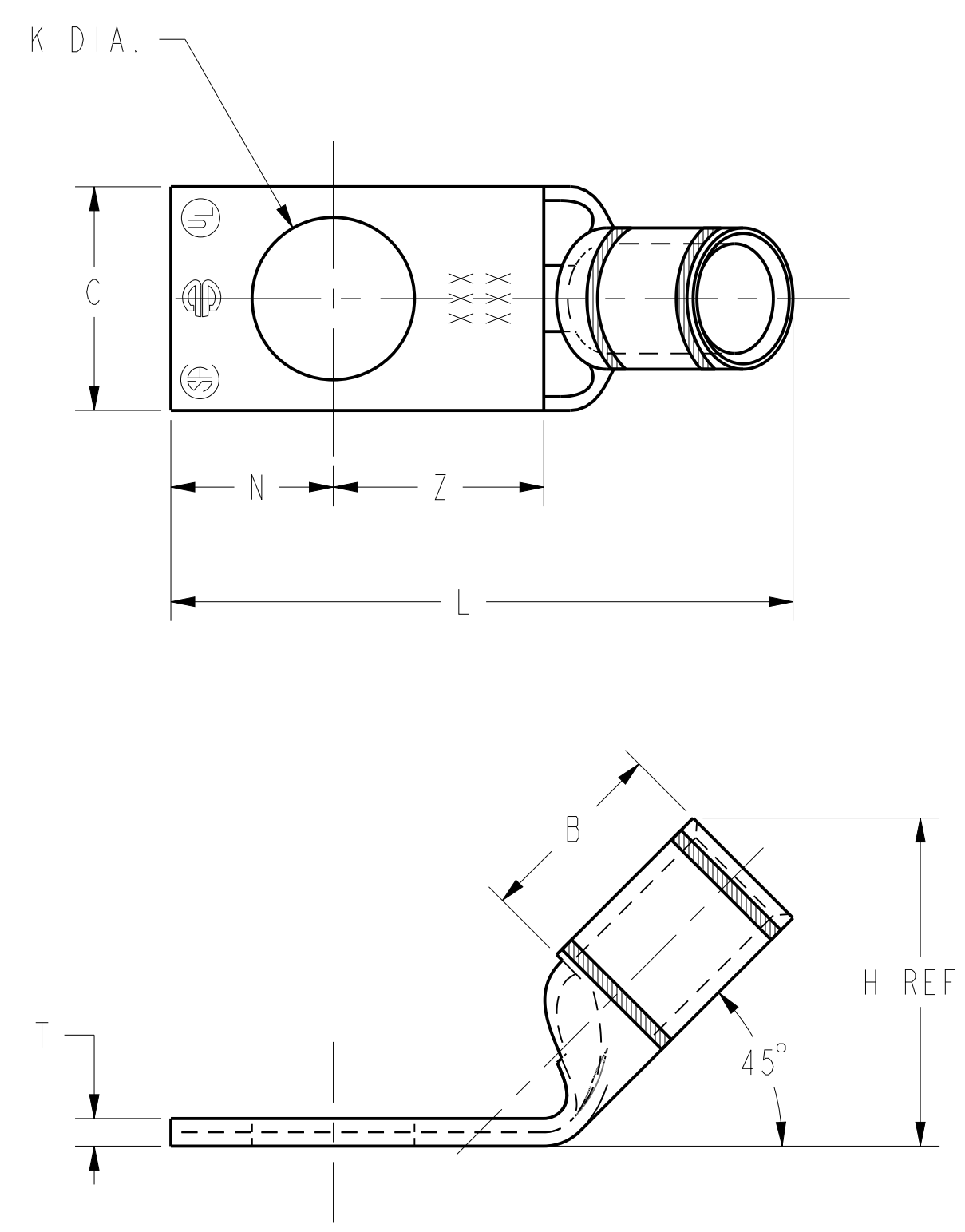

FIG. 2

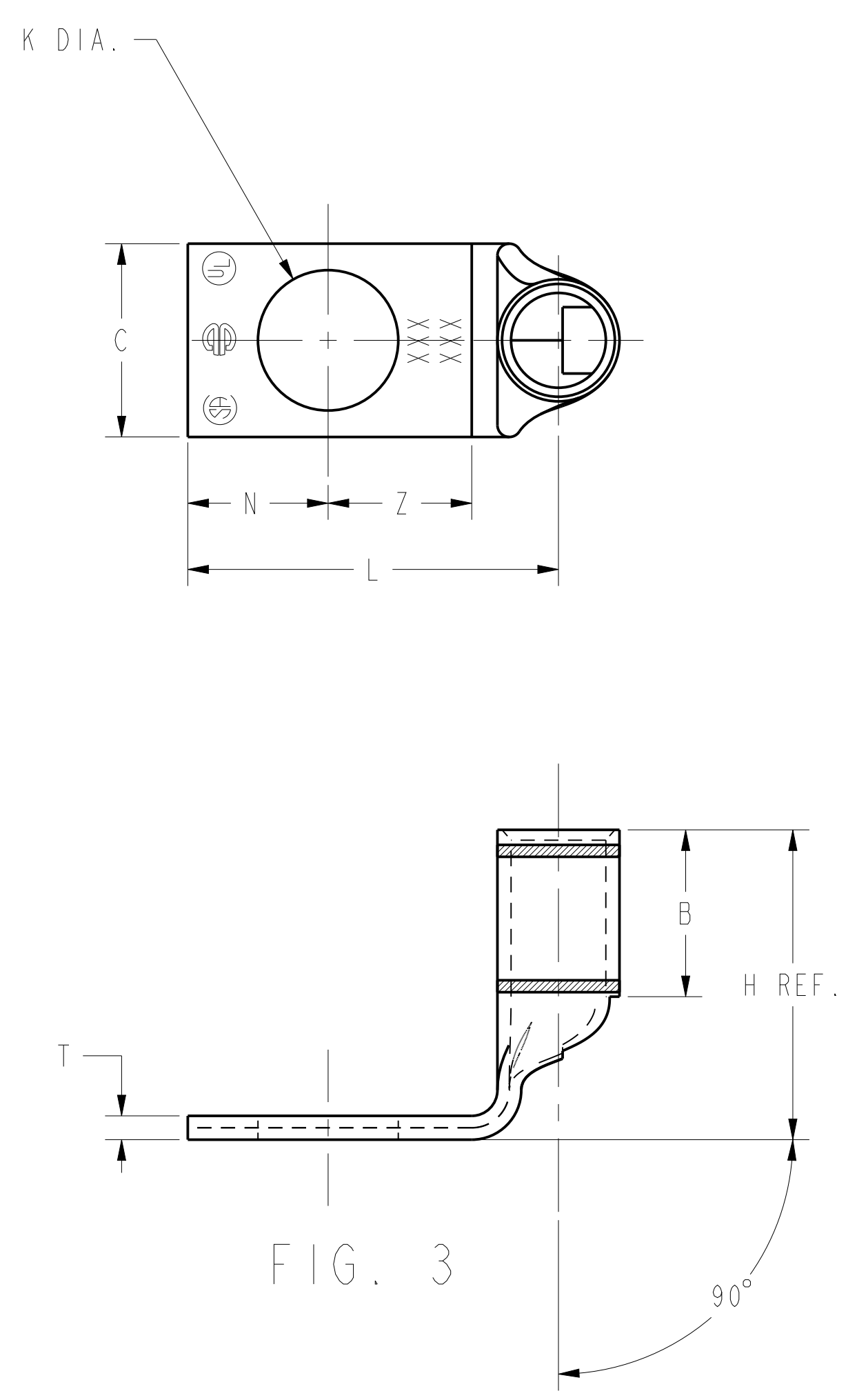

FIG. 3

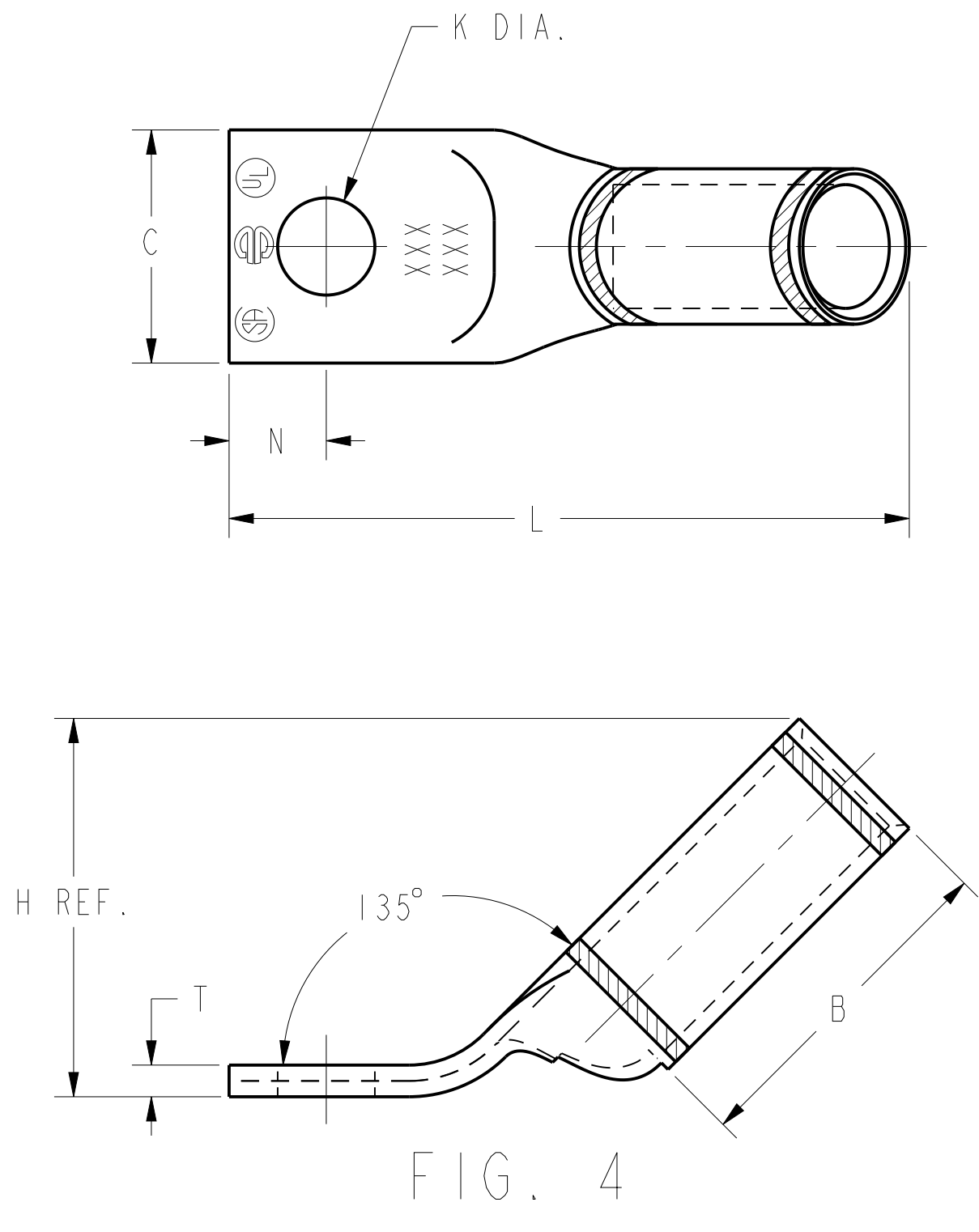

FIG. 4

NOTES:

1. MATERIAL: COPPER TUBING.
2. FINISH: TIN PLATED. THE FOLLOWING SUFFIXES DENOTE OPTIONAL PLATING TYPES. BR=BARE; LD=LEAD; NK=NICKEL; SV=SILVER. (EXAMPLE: YAV6CLTC38FXBR).
3. CATALOG # PT6515 ADAPTOR IS REQUIRED TO USE "U" DIES IN Y45 SERIES TOOLS.
4. CATALOG # PUADP-1 ADAPTOR IS REQUIRED TO USE "U" DIES IN Y46 SERIES TOOLS.
5. NAVY CABLE SIZE MAY BE OMITTED ON SOME SIZES BECAUSE OF SPACE LIMITATIONS.
6. PERMANENT DIE IN TOOLING.
7. DIMENSIONS IN [ ] BRACKETS ARE IN MILLIMETERS, ROUNDED OFF TO THE NEAREST MILLIMETER UNLESS OTHERWISE NOTED. METRIC DIMENSIONS ARE FOR REFERENCE ONLY.
8. IF HIGHEST REVISION OF THIS SALES PRINT IS AFFECTED, UPDATE PRINT WSA208758 TO INCLUDE THE NEW REVISION.
9. ALL OF THE CATALOG NUMBERS FOR THESE HYLUGS™, CAN BE ORDERED WITH OR WITHOUT SKIVE.  
EXAMPLE: YA34L-TC12-FX (SKIVE)  
YAG34L-TC12-FX (NO SKIVE)
10. UL LISTED AND CSA CERTIFIED CONNECTORS.
11. UNDRILLED VERSIOSNS ARE NOT UL LISTED OR CSA CERTIFIED.
12. FOR UNDRILLED VERSIONS ADD SUFFIX "-U" TO END OF CATALOG NUMBER.  
FOR UNDRILLED VERSIONS, USE D MIN. = N MAX. + Z MIN.
13. THESE CATALOG NUMBERS CANNOT BE INSTALLED WITH Y45 OR Y46 TOOLING.

TO ORDER BURNDY® PRODUCTS CALL		HYLUG™	
UNITED STATES		DRAWING NO	
1-800-346-4175 (LONDONDERRY, NH)		REV	
CANADA:		SCALE: NTS	
1-800-361-6975 (QUEBEC)		PROJECT #	
1-800-387-6487 (ALL OTHER PROVINCES)		SIZE	
FOR PRODUCT INFO: <a href="http://www.burndy.com">http://www.burndy.com</a>		DOCUMENT TYPE: Sales	
		REL LEVEL: Released	
		D	
		SE208001	
		SHEET 1 OF 18	
		M	

REV: PEO200

REV	DATE	DESCRIPTION	ECO	BY	CHK.
M	05/05/2017 16:12:00 PM	YA32LN516FX135 ADDED AS PER MU	46658	SM	MB

D	CATALOG NO.	COPPER CONDUCTOR			BOLT SIZE	FIG. NO.	DIMENSIONS							BURNDY® INSTALLATION TOOLING (# CRIMPS)										D																
		FLEX	CODE (AWG)	NAVY			B	C	H	K	L	N	O.D.	T REF.	Z MIN.	DIE INDEX	COLOR CODE	MECHANICAL			HYDRAULIC				DIELESS (# CRIMPS)	WIRE STRIP LENGTH														
																		MD7-34R MD6	OUR840	YIMRTC Y122CMR	PATMD6, PAT600, YCT500	Y750, Y35, Y39, BAT35, PAT750	Y46 PAT46				Y45													
YAV6CLTC10FX	6 AWG CLASS G-M DLO(61/24)	#6 AWG CLASS B,C	30	#10	1	.50 [13]	-----	1.30 [33]	.25 [6]	.31 [8]	.08 [2]	.27 [7]	7 OR 374	BLUE	W5CRT X5CRT W5CVT (1)	X5CRT W5CVT (1)	(1 CRIMP)	W5CRT X5CRT W5CVT (1)	U5CRT (1)	U5CRT (1)	U5CRT (1)	MECHANICAL: MY29-11 (1)	HYDRAULIC: Y644M (1) PAT644 (1) Y81KFT (1) PAT81KFT (1) Y4PC834 (1) PAT4PC834 (1)	1/2"																
YAV6CLTC10FX45	16 mm² CLASS 5		2			.48 [12]	.78 [20]	.21 [5]																	1.26 [32]															
YAV6CLTC10FX90			3			.90 [23]	.76 [19]																																	
YAV6CLTC14FX				1/4	1	.48 [12]	-----	1.43 [36]	.31 [8]	.08 [2]	.33 [8]	7 OR 374	BLUE	W5CRT X5CRT W5CVT (1)	X5CRT W5CVT (1)	(1 CRIMP)	W5CRT X5CRT W5CVT (1)	U5CRT (1)	U5CRT (1)	U5CRT (1)	MECHANICAL: MY29-11 (1)	HYDRAULIC: Y644M (1) PAT644 (1) Y81KFT (1) PAT81KFT (1) Y4PC834 (1) PAT4PC834 (1)	1/2"																	
YAV6CLTC14FX45			2				.78 [20]	.27 [7]																1.39 [35]																
YAV6CLTC14FX90			3				.90 [23]	.88 [22]																																
YAV6CLTC516FX				5/16	1	.52 [13]	-----	1.49 [38]	.34 [9]	.07 [2]	.36 [9]	7 OR 374	BLUE	W5CRT X5CRT W5CVT (1)	X5CRT W5CVT (1)	(1 CRIMP)	W5CRT X5CRT W5CVT (1)	U5CRT (1)	U5CRT (1)	U5CRT (1)	MECHANICAL: MY29-11 (1)	HYDRAULIC: Y644M (1) PAT644 (1) Y81KFT (1) PAT81KFT (1) Y4PC834 (1) PAT4PC834 (1)	1/2"																	
YAV6CLTC516FX45			2				.78 [20]	.33 [8]																1.44 [37]																
YAV6CLTC516FX90			3				.89 [23]	.94 [24]																																
YAV6CLTC38FX				3/8	1	.58 [15]	-----	1.61 [41]	.41 [10]	.06 [2]	.42 [11]	7 OR 374	BLUE	W5CRT X5CRT W5CVT (1)	X5CRT W5CVT (1)	(1 CRIMP)	W5CRT X5CRT W5CVT (1)	U5CRT (1)	U5CRT (1)	U5CRT (1)	MECHANICAL: MY29-11 (1)	HYDRAULIC: Y644M (1) PAT644 (1) Y81KFT (1) PAT81KFT (1) Y4PC834 (1) PAT4PC834 (1)	1/2"																	
YAV6CLTC38FX45			2				.77 [20]	.40 [10]																1.54 [39]																
YAV6CLTC38FX90			3				.87 [22]	1.06 [27]																																
YAV6CLTC12FX				1/2	1	.75 [19]	-----	1.86 [47]	.53 [13]	.12 [3]	.55 [14]	7 OR 374	BLUE	W5CRT X5CRT W5CVT (1)	X5CRT W5CVT (1)	(1 CRIMP)	W5CRT X5CRT W5CVT (1)	U5CRT (1)	U5CRT (1)	U5CRT (1)	MECHANICAL: MY29-11 (1)	HYDRAULIC: Y644M (1) PAT644 (1) Y81KFT (1) PAT81KFT (1) Y4PC834 (1) PAT4PC834 (1)	1/2"																	
YAV6CLTC12FX45			2				.80 [20]	.53 [13]																1.92 [49]																
YAV6CLTC12FX90			3				.98 [25]	1.34 [34]																																
YAV6CLTC34FX				3/4	1	1.04 [26]	-----	2.66 [68]	.75 [19]	.09 [2]	.97 [25]	7 OR 374	BLUE	W5CRT X5CRT W5CVT (1)	X5CRT W5CVT (1)	(1 CRIMP)	W5CRT X5CRT W5CVT (1)	U5CRT (1)	U5CRT (1)	U5CRT (1)	MECHANICAL: MY29-11 (1)	HYDRAULIC: Y644M (1) PAT644 (1) Y81KFT (1) PAT81KFT (1) Y4PC834 (1) PAT4PC834 (1)	1/2"																	
YAV6CLTC34FX45	6 AWG CLASS G-M DLO(61/24)		2				.83 [21]	.81 [21]																2.46 [62]																
YAV6CLTC34FX90			3				1.01 [26]	1.86 [47]																																
YAV6CLTC14FX135	16 mm² CLASS 5	#6 AWG CLASS B, C	30	1/4	4	.50 [13]	.48 [12]	.61 [15]	.27 [7]	1.55 [39]	.31 [8]	.33 [8]	7 OR 374	BLUE	W5CRT X5CRT W5CVT (1)	X5CRT W5CVT (1)	(1 CRIMP)	W5CRT X5CRT W5CVT (1)	U5CRT (1)	U5CRT (1)	U5CRT (1)	MECHANICAL: MY29-11 (1)	HYDRAULIC: Y644M (1) PAT644 (1) Y81KFT (1) PAT81KFT (1) Y4PC834 (1) PAT4PC834 (1)	1/2"																

SEE SHEET 1 OF 18 FOR NOTES

TO ORDER BURNDY® PRODUCTS CALL  
 UNITED STATES  
 1-800-346-4175 (LONDONDERRY, NH)  
 CANADA:  
 1-800-361-6975 (QUEBEC)  
 1-800-387-6487 (ALL OTHER PROVINCES)  
 FOR PRODUCT INFO: <http://www.burndy.com>

HYLUG™

ITEM NO:	N/A
CAT. NO:	YAV6CL-TCLFX- (TABLE)
DRAWN BY:	D FILLION 11/30/92
CHECKER:	K HENRY 12/02/92
DSN APPVL:	C PALAGI 12/04/92
MFG APPVL:	--
QA APPVL:	A LLOYD 12/07/92
MKT APPVL:	--
PROD FAM:	CM&R Compression
PROJECT #:	SIZE
DOCUMENT TYPE:	Sales
REL LEVEL:	Released

BURNDY

SCALE: 1:1  
 DRAWING NO: SE208001  
 SHEET 2 OF 18  
 REV: M

REV: PEO200



REV	DATE	DESCRIPTION	ECO	BY	C.H.K.
M	05/05/2017 16:12:00 PM	YA32LN516FX135 ADDED AS PER MU	46658	SM	MB

D	CATALOG NO.	CONDUCTOR			BOLT SIZE	FIG. NO.	DIMENSIONS								BURNDY® INSTALLATION TOOLING (# CRIMPS)								WIRE STRIP LENGTH	D		
		FLEX	CODE (AWG)	5 NAVY			B	C	H	K	L	N	O.D.	T REF.	Z MIN.	DIE INDEX	COLOR CODE	MECHANICAL			HYDRAULIC				DIELESS (# CRIMPS)	
																		MD7-34R MD6	OUR840	YIMRTC Y122CMR	PATMD6, PAT600, YCT500	Y750, Y35 Y39, BAT35 PAT750				Y46 PAT46
YAV3CLTC14FX	3 AWG FLEX G-M 25 mm <sup>2</sup> CLASS 5	3 AWG CLASS B,C	--	1/4	I	.88 [22]	.60 [15]	-----	.27 [7]	1.84 [47]	.31 [8]	.42 [11]	.11 [3]	.33 [8]	9	WHITE	W3CRT (1)	X3CRT (1)	(1 CRIMP)	W3CRT (1)	U3CRT (1)	U3CRT (1)	U3CRT (1)	MECHANICAL: MY29-11 (1) HYDRAULIC: Y644M (1) PAT644 (1) Y81KFT (1) PAT81KFT (1) Y4PC834 (1) PAT4PC834 (1)	15/16"	

C

C

B

B

A

A

SEE SHEET 1 OF 18 FOR NOTES

TO ORDER BURNDY® PRODUCTS CALL		HYLUG™	
UNITED STATES 1-800-346-4175 (LONDONDERRY, NH)		ITEM NO: 518541	
CANADA: 1-800-361-6975 (QUEBEC) 1-800-387-6487 (ALL OTHER PROVINCES)		CAT. NO: YAV3CL-TCLFX- (TABLE)	
FOR PRODUCT INFO: <a href="http://www.burndy.com">http://www.burndy.com</a>		DRAWN BY: D FILLION 11/25/92	
		CHECKER: K HENRY 10/02/92	
		DSN APPVL: C PALAGI 12/04/92	
		MFG APPVL: -- --	
		QA APPVL: A LLOYD 12/07/92	
		MKT APPVL: T NELSON 12/04/92	
		PROD FAM: CM&R Compression	
		DRAWING NO	
		PROJECT #: -- SIZE	
		DOCUMENT TYPE: Sales	
		REL LEVEL: Released	
		SCALE: 3:1	
		SE208001	
		SHEET 4 OF 18	
		M	

REV: PE0200

REV	DATE	DESCRIPTION	ECO	BY	C'H'K.
M	05/05/2017 16:12:00 PM	YA32LN516FX135 ADDED AS PER MU	46658	SM	MB

D	CATALOG NO.	CONDUCTOR			BOLT SIZE	FIG. NO.	DIMENSIONS							BURNDY® INSTALLATION TOOLING (# CRIMPS)										DIELESS (# CRIMPS)	WIRE STRIP LENGTH																			
		FLEX	CODE (AWG)	5 NAVY			B	C	H	K	L	N	O.D.	T REF.	Z MIN.	DIE INDEX	COLOR CODE	MECHANICAL			HYDRAULIC																							
																		MD7-34R MD6	OUR840	Y1MRTC Y122CMR 6	PATMD6, PAT600, YCT500	Y750, Y35 Y39, BAT35 PAT750	Y46 PAT46 4			Y45 3																		
YAV2CLTC10FX	2 AWG CLASS G-M DLO(125/24) (150/24)	2 AWG CLAS B,C	60	#10 [M5]	.63 [16]	-----	.21 [5]	1.50 [38]	.25 [6]	.46 [12]	.10 [3]	.27 [7]	10	BROWN	W2CRT X2CRT W2CVT (1)	X2CRT W2CVT (1)	(2 CRIMP)	W2CRT X2CRT W2CVT (1)	U2CRT (1)	U2CRT (1)	U2CRT (1)	MECHANICAL: MY29-11 (1)	11/16"																					
YAV2CLTC10FX45																								35 mm² CLASS 5	1/4 [M6]	1	.68 [17]	1.04 [26]	.27 [7]	1.62 [41]	.31 [8]	.10 [3]	.33 [8]	10	BROWN	W2CRT X2CRT W2CVT (1)	X2CRT W2CVT (1)	(2 CRIMP)	W2CRT X2CRT W2CVT (1)	U2CRT (1)	U2CRT (1)	U2CRT (1)	MECHANICAL: MY29-11 (1)	11/16"
YAV2CLTC10FX90																								35 mm² CLASS 5																				
YAV2CLTC14FX	2 AWG CLASS G-M DLO(125/24) (150/24)	2 AWG CLAS B,C	60	1/4 [M6]	1	.68 [17]	1.04 [26]	.27 [7]	1.58 [40]	.31 [8]	.10 [3]	.33 [8]	10	BROWN	W2CRT X2CRT W2CVT (1)	X2CRT W2CVT (1)	(2 CRIMP)	W2CRT X2CRT W2CVT (1)	U2CRT (1)	U2CRT (1)	U2CRT (1)	MECHANICAL: MY29-11 (1)	11/16"																					
YAV2CLTC14FX45																								35 mm² CLASS 5	3/8 [M10]	2	.68 [17]	1.04 [26]	.40 [10]	1.77 [45]	.41 [10]	.10 [3]	.42 [11]	10	BROWN	W2CRT X2CRT W2CVT (1)	X2CRT W2CVT (1)	(2 CRIMP)	W2CRT X2CRT W2CVT (1)	U2CRT (1)	U2CRT (1)	U2CRT (1)	MECHANICAL: MY29-11 (1)	11/16"
YAV2CLTC14FX90																								35 mm² CLASS 5																				
YAV2CLTC516FX	2 AWG CLASS G-M DLO(125/24) (150/24)	2 AWG CLAS B,C	60	1/4 [M6]	1	.68 [17]	1.04 [26]	.27 [7]	1.69 [43]	.31 [8]	.10 [3]	.33 [8]	10	BROWN	W2CRT X2CRT W2CVT (1)	X2CRT W2CVT (1)	(2 CRIMP)	W2CRT X2CRT W2CVT (1)	U2CRT (1)	U2CRT (1)	U2CRT (1)	MECHANICAL: MY29-11 (1)	11/16"																					
YAV2CLTC516FX45																								35 mm² CLASS 5	5/8 [M16]	1	1.02 [26]	-----	.69 [18]	2.37 [60]	.66 [17]	.14 [4]	.67 [17]	10	BROWN	W2CRT X2CRT W2CVT (1)	X2CRT W2CVT (1)	(2 CRIMP)	W2CRT X2CRT W2CVT (1)	U2CRT (1)	U2CRT (1)	U2CRT (1)	MECHANICAL: MY29-11 (1)	11/16"
YAV2CLTC516FX90																								35 mm² CLASS 5																				
YAV2CLTC38FX	2 AWG CLASS G-M DLO(125/24) (150/24)	2 AWG CLAS B,C	60	3/8 [M10]	2	.68 [17]	1.04 [26]	.40 [10]	1.77 [45]	.41 [10]	.10 [3]	.42 [11]	10	BROWN	W2CRT X2CRT W2CVT (1)	X2CRT W2CVT (1)	(2 CRIMP)	W2CRT X2CRT W2CVT (1)	U2CRT (1)	U2CRT (1)	U2CRT (1)	MECHANICAL: MY29-11 (1)	11/16"																					
YAV2CLTC38FX45																								35 mm² CLASS 5	1/2 [M12]	3	.68 [17]	1.04 [26]	.33 [8]	1.03 [26]	.34 [9]	.10 [3]	.36 [9]	10	BROWN	W2CRT X2CRT W2CVT (1)	X2CRT W2CVT (1)	(2 CRIMP)	W2CRT X2CRT W2CVT (1)	U2CRT (1)	U2CRT (1)	U2CRT (1)	MECHANICAL: MY29-11 (1)	11/16"
YAV2CLTC38FX90																								35 mm² CLASS 5																				
YAV2CLTC12FX	2 AWG CLASS G-M DLO(125/24) (150/24)	2 AWG CLAS B,C	60	1/2 [M12]	2	.73 [18]	1.07 [27]	.53 [13]	2.03 [52]	.53 [13]	.09 [2]	.55 [14]	10	BROWN	W2CRT X2CRT W2CVT (1)	X2CRT W2CVT (1)	(2 CRIMP)	W2CRT X2CRT W2CVT (1)	U2CRT (1)	U2CRT (1)	U2CRT (1)	MECHANICAL: MY29-11 (1)	11/16"																					
YAV2CLTC12FX45																								35 mm² CLASS 5	5/8 [M16]	1	1.02 [26]	-----	.69 [18]	2.37 [60]	.66 [17]	.14 [4]	.67 [17]	10	BROWN	W2CRT X2CRT W2CVT (1)	X2CRT W2CVT (1)	(2 CRIMP)	W2CRT X2CRT W2CVT (1)	U2CRT (1)	U2CRT (1)	U2CRT (1)	MECHANICAL: MY29-11 (1)	11/16"
YAV2CLTC12FX90																								35 mm² CLASS 5																				
YAV2CLTC14FX135	2 AWG CLASS G-M DLO(125/24) (150/24)	2 AWG CLAS B,C	60	1/4 [M6]	1	.68 [17]	1.04 [26]	.27 [7]	1.84 [47]	.31 [8]	.10 [3]	.33 [8]	10	BROWN	W2CRT X2CRT W2CVT (1)	X2CRT W2CVT (1)	(2 CRIMP)	W2CRT X2CRT W2CVT (1)	U2CRT (1)	U2CRT (1)	U2CRT (1)	MECHANICAL: MY29-11 (1)	11/16"																					
YAV2CLTC58FX																								35 mm² CLASS 5	5/8 [M16]	1	1.02 [26]	-----	.69 [18]	2.37 [60]	.66 [17]	.14 [4]	.67 [17]	10	BROWN	W2CRT X2CRT W2CVT (1)	X2CRT W2CVT (1)	(2 CRIMP)	W2CRT X2CRT W2CVT (1)	U2CRT (1)	U2CRT (1)	U2CRT (1)	MECHANICAL: MY29-11 (1)	11/16"
YAV2CLNT14FX																								35 mm² CLASS 5																				

SEE SHEET 1 OF 18 FOR NOTES

TO ORDER BURNDY® PRODUCTS CALL  
 UNITED STATES  
 1-800-346-4175 (LONDONDERRY, NH)  
 CANADA:  
 1-800-361-6975 (QUEBEC)  
 1-800-387-6487 (ALL OTHER PROVINCES)  
 FOR PRODUCT INFO: <http://www.burndy.com>

HYLUG™

ITEM NO:	N/A
CAT. NO:	YAV2CL-TC-FX- (TABLE)
DRAWN BY:	D FILLION 11/30/92
CHECKER:	K HENRY 12/02/92
DSN APPVL:	C PALAGI 12/04/92
MFG APPVL:	--
QA APPVL:	A LLOYD 12/07/92
MKT APPVL:	T NELSON 12/04/92
PROD FAM:	CM&R Compression
PROJECT #:	--
DOCUMENT TYPE:	Sales
REL LEVEL:	Released

BURNDY

DRAWING NO	SE208001	SCALE	1:1
REV	M		

SHEET 5 OF 18

REV: PEO200

REV	DATE	DESCRIPTION	ECO	BY	C.H.K.
M	05/05/2017 16:12:00 PM	YA32LN516FX135 ADDED AS PER MU	46658	SM	MB

D

D

C

C

B

B

A

A

CATALOG NO.	CONDUCTOR			BOLT SIZE	FIG. NO.	DIMENSIONS							BURNDY® INSTALLATION TOOLING (# CRIMPS)										
	FLEX	CODE (AWG)	5 NAVY			B	C	H	K	L	N	O.D.	T REF.	Z MIN.	DIE INDEX	COLOR CODE	MECHANICAL		HYDRAULIC			DIELESS (# CRIMPS)	WIRE STRIP LENGTH
																	MD7-34R MD6	OUR840	PATMD6, PAT600, YCT500	Y750, Y35 Y39, BAT35 PAT750	Y46 PAT46		
YAVICLTC10FX	1 AWG CLASS G-M DLO (175/24) (225/24)	1 AWG CLASS B,C	75	#10 [M5]	1	.62 [16]	.75 [19]	-----	1.52 [39]	.25 [6]	.51 [13]	.12 [3]	.27 [7]	11 OR 375	GREEN	WICRT	XICRT	WICRT	UICRT (1)	UICRT (1)	UICRT (1)	MECHANICAL: MY29-11 (1)  HYDRAULIC: Y644M (1) PAT644 (1) Y81KFT (1) PAT81KFT (1) Y4PC834 (1) PAT4PC834 (1)	11/16"
2					1.10 [28]	.21 [5]	1.52 [39]	WICRT	XICRT							WICRT	UICRT (1)	UICRT (1)	UICRT (1)				
3					1.20 [30]		.88 [22]	WICRT	XICRT							WICRT	UICRT (1)	UICRT (1)	UICRT (1)				
YAVICLTC14FX				1/4 [M6]	1			1.65 [42]	.31 [8]							WICRT	XICRT	WICRT	UICRT (1)	UICRT (1)	UICRT (1)		
2					1.10 [28]	.27 [7]	1.64 [42]	WICRT								XICRT	WICRT	UICRT (1)	UICRT (1)	UICRT (1)			
3					1.20 [30]		1.00 [25]	WICRT								XICRT	WICRT	UICRT (1)	UICRT (1)	UICRT (1)			
YAVICLTC516FX				5/16 [M8]	1			1.71 [43]	.34 [9]							WICRT	XICRT	WICRT	UICRT (1)	UICRT (1)	UICRT (1)		
2					1.10 [28]	.33 [8]	1.70 [43]	WICRT								XICRT	WICRT	UICRT (1)	UICRT (1)	UICRT (1)			
3					1.20 [30]		1.07 [27]	WICRT								XICRT	WICRT	UICRT (1)	UICRT (1)	UICRT (1)			
YAVICLTC38FX				3/8 [M10]	1			1.84 [47]	.41 [10]							WICRT	XICRT	WICRT	UICRT (1)	UICRT (1)	UICRT (1)		
2					1.10 [28]	.41 [10]	1.83 [46]	WICRT								XICRT	WICRT	UICRT (1)	UICRT (1)	UICRT (1)			
3					1.20 [30]		1.19 [30]	WICRT								XICRT	WICRT	UICRT (1)	UICRT (1)	UICRT (1)			
YAVICLTC12FX				1/2 [M12]	1			2.09 [53]	.53 [13]							WICRT	XICRT	WICRT	UICRT (1)	UICRT (1)	UICRT (1)		
2					1.10 [28]	.53 [13]	2.08 [53]	WICRT								XICRT	WICRT	UICRT (1)	UICRT (1)	UICRT (1)			
3					.62 [16]	.75 [19]	1.20 [30]	1.44 [37]								.51 [13]	.12 [3]	.55 [14]	11 OR 375	GREEN	WICRT		

SEE SHEET 1 OF 18 FOR NOTES

TO ORDER BURNDY® PRODUCTS CALL		HYLUG™	
UNITED STATES 1-800-346-4175 (LONDONDERRY, NH)		ITEM NO: N/A	
CANADA: 1-800-361-6975 (QUEBEC) 1-800-387-6487 (ALL OTHER PROVINCES)		CAT. NO: YAVICL-TC-FX-	
FOR PRODUCT INFO: <a href="http://www.burndy.com">http://www.burndy.com</a>		DRAWN BY: R NARESH 04/06/05	
		CHECKER: K BABU 04/06/05	
		DSN APPVL: -- --	
		MFG APPVL: -- --	
		QA APPVL: -- --	
		MKT APPVL: -- --	
		SCALE: 1:1	
		PROD. FAM: CM&R Compression	
		DRAWING NO: SE208001	
		PROJECT #: --	
		DOCUMENT TYPE: Sales	
		REL LEVEL: Released	
		SHEET 6 OF 18	
		M	

REV: PEO200

REV	DATE	DESCRIPTION	ECO	BY	C'H'K.
M	05/05/2017 16:12:00 PM	YA32LN516FX135 ADDED AS PER MU	46658	SM	MB

D

D

C

C

B

B

A

A

CATALOG NO.	CONDUCTOR			BOLT SIZE	FIG. NO.	DIMENSIONS								BURNDY® INSTALLATION TOOLING (#CRIMPS)																								
	FLEX	CODE (AWG)	5 NAVY			B	C	H	K	L	N	O.D.	T REF.	Z MIN.	DIE INDEX	COLOR CODE	MECHANICAL RATCHET		HYDRAULIC			DIELESS (# CRIMPS)	WIRE STRIP LENGTH															
																	MD7-34R MD6	OUR840	BCT500 Y500CT PAT600	Y750 Y35, Y39 PAT750	Y46 PAT46 4			Y45 3														
YAV25LTC10FX	1/0 AWG CLASS G-M DLO (275/24) 50 mm² CLASS 5	1/0 AWG CLASS B,C	100	10	.69 [18]	.83 [21]	-----	.21 [5]	1.63 [41]	.25 [6]	.56 [14]	.12 [3]	.27 [7]	12 OR 348	PINK	W25RT	X25RT	W25RT	U25RT	U25RT	U25RT	MECHANICAL: MY29-11 (1)  HYDRAULIC: Y644M (1) PAT644 (1) Y81KFT (1) PAT81KFT (1) Y4PC834 (1) PAT4PC834 (1)	11/16"															
YAV25LTC14FX				1/4	1	.21 [5]	1.63 [41]	.25 [6]	.56 [14]	.12 [3]						.27 [7]	1.75 [44]	12 OR 348	PINK	W25RT	X25RT			W25RT	U25RT	U25RT	U25RT											
YAV25LTC14FX45					2												1.20 [30]											.27 [7]	1.71 [43]	.31 [8]	12 OR 348	PINK	W25RT	X25RT	W25RT	U25RT	U25RT	U25RT
YAV25LTC14FX90					3												1.31 [33]											1.03 [26]	12 OR 348	PINK								
YAV25LTC516FX				5/16	1	.21 [5]	1.63 [41]	.25 [6]	.56 [14]	.12 [3]						.27 [7]	1.81 [46]	12 OR 348	PINK	W25RT	X25RT			W25RT	U25RT	U25RT	U25RT											
YAV25LTC516FX45					2												1.20 [30]											.33 [8]			1.77 [45]	.34 [9]	12 OR 348	PINK	W25RT	X25RT	W25RT	U25RT
YAV25LTC516FX90					3												1.31 [33]											1.09 [28]	12 OR 348	PINK	W25RT	X25RT						
YAV25LTC38FX				3/8	1	.21 [5]	1.63 [41]	.25 [6]	.56 [14]	.12 [3]						.27 [7]	1.94 [49]	12 OR 348	PINK	W25RT	X25RT			W25RT	U25RT	U25RT	U25RT											
YAV25LTC38FX45					2												1.20 [30]											.40 [10]					1.90 [48]	.41 [10]	12 OR 348	PINK	W25RT	X25RT
YAV25LTC38FX90					3												1.31 [33]											1.22 [31]	12 OR 348	PINK	W25RT	X25RT	W25RT	U25RT				
YAV25LTC12FX	1/2	1	.21 [5]	1.63 [41]	.25 [6]	.56 [14]	.12 [3]	.27 [7]	2.19 [56]	12 OR 348	PINK	W25RT	X25RT	W25RT	U25RT	U25RT	U25RT																					
YAV25LTC12FX45		2							1.20 [30]									.53 [13]	2.15 [55]	.53 [13]	12 OR 348	PINK	W25RT	X25RT	W25RT	U25RT	U25RT	U25RT										
YAV25LTC12FX90		3							1.31 [33]									1.47 [37]	12 OR 348	PINK									W25RT	X25RT	W25RT	U25RT	U25RT	U25RT				

SEE SHEET 1 OF 18 FOR NOTES

TO ORDER BURNDY® PRODUCTS CALL		HYLUG™	
UNITED STATES 1-800-346-4175 (LONDONDERRY, NH)		ITEM NO: N/A	CAT. NO: YAV25L-TC-FX-
CANADA: 1-800-361-6975 (QUEBEC) 1-800-387-6487 (ALL OTHER PROVINCES)		DRAWN BY: D FILLION 11/30/92	CHECKER: K HENRY 12/02/92
FOR PRODUCT INFO: <a href="http://www.burndy.com">http://www.burndy.com</a>		DSN APPVL: C PALAGI 12/04/92	MFG APPVL: --
		QA APPVL: A LLOYD 12/07/92	MKT APPVL: T NELSON 12/04/92
		PROD FAM: CM&R Compression	DRAWING NO: SE208001
		PROJECT #: --	SCALE: 1:1
		DOCUMENT TYPE: Sales	SHEET 7 OF 18
		REL LEVEL: Released	M

REV: PEO200

REV	DATE	DESCRIPTION	ECO	BY	C.H.K.
M	05/05/2017 16:12:00 PM	YA32LN516FX135 ADDED AS PER MU	46658	SM	MB

D	CONDUCTOR			BOLT SIZE	CATALOG NO.	FIG. NO.	DIMENSIONS							BURNDY® INSTALLATION TOOLING (# CRIMPS)							DIELESS (# CRIMPS)	WIRE STRIP LENGTH	D				
	FLEX	CODE (AWG)	NAVY 5				B	C	H	K	L	N	O.D.	T REF.	Z MIN.	DIE INDEX	COLOR CODE	MECHANICAL RATCHET		HYDRAULIC							
																		MD7-34R MD6	OUR840	BCT500 Y500CT PAT600				Y750, Y35 Y39 PAT750	Y46 PAT46	Y45	
C	2/0 AWG CLASS G-M DLO (325/24) 70 mm² CLASS 5	2/0 AWG CLASS B,C	125	#10 [M5]	YAV26LTC10FX	1	.81 [21]	.93 [24]	-----	1.80 [46]		.63 [16]	.13 [3]		13	BLACK	W26RT X26RT W26VT (2)	X26RT W26VT (2)	W26RT X26RT W26VT (2)	U26RT UR5184WE (1)	U26RT UR5184WE (1)	U26RT UR5184WE (1)	MECHANICAL: MY29-11 (1)  HYDRAULIC: Y644M (1) PAT644 (1) Y81KFT (1) PAT81KFT (1) Y4PC834 (1) PAT4PC834 (1)	13/16"			
					YAV26LTC10FX45	2	1.38 [35]	.21 [5]	1.73 [44]	.25 [6]			.27 [7]														
					YAV26LTC10FX90	3	1.49 [38]		.94 [24]																		
					YAV26LTC14FX	1	-----	1.92 [49]																			
					YAV26LTC14FX45	2	1.38 [35]	.27 [7]	1.85 [47]	.31 [8]			.33 [8]														
					YAV26LTC14FX90	3	1.49 [38]		1.07 [27]																		
	B	2/0 AWG CLASS G-M DLO (325/24) 70 mm² CLASS 5	2/0 AWG CLASS B,C	125	5/16 [M8]	YAV26LTC516FX	1	-----	1.98 [50]																	MECHANICAL: MY29-11 (1)  HYDRAULIC: Y644M (1) PAT644 (1) Y81KFT (1) PAT81KFT (1) Y4PC834 (1) PAT4PC834 (1)	13/16"
						YAV26LTC516FX45	2	1.38 [35]	.33 [8]	1.92 [49]	.34 [9]			.36 [9]													
						YAV26LTC516FX90	3	1.49 [38]		1.13 [29]																	
						YAV26LTC38FX	1	-----	2.11 [54]																		
						YAV26LTC38FX45	2	1.38 [35]	.40 [10]	2.04 [52]	.41 [10]			.42 [11]													
						YAV26LTC38FX90	3	1.49 [38]		1.26 [32]																	
A	2/0 AWG CLASS G-M DLO (325/24) 70 mm² CLASS 5	2/0 AWG CLASS B,C	125	1/2 [M12]	YAV26LTC12FX	1	-----	2.36 [60]															MECHANICAL: MY29-11 (1)  HYDRAULIC: Y644M (1) PAT644 (1) Y81KFT (1) PAT81KFT (1) Y4PC834 (1) PAT4PC834 (1)	13/16"			
					YAV26LTC12FX45	2	1.38 [35]	.53 [13]	2.29 [58]	.53 [13]			.55 [14]														
					YAV26LTC12FX90	3	1.49 [38]		1.51 [38]																		
					YAV26LTC58FX	1	-----	2.61 [66]																			
					YAV26LTC58FX45	2	1.38 [35]	.69 [17]	2.54 [65]	.66 [17]			.67 [17]														
					YAV26LTC58FX90	3	1.49 [38]		1.76 [45]																		
A	2/0 AWG CLASS G-M DLO (325/24) 70 mm² CLASS 5	2/0 AWG CLASS B,C	125	3/4 [M20]	YAV26LTC34FX	1	-----	2.89 [73]														MECHANICAL: MY29-11 (1)  HYDRAULIC: Y644M (1) PAT644 (1) Y81KFT (1) PAT81KFT (1) Y4PC834 (1) PAT4PC834 (1)			13/16"		
					YAV26LTC34FX45	2	1.44 [37]	.81 [21]	2.75 [70]	.75 [19]			.77 [19]														
					YAV26LTC34FX90	3	1.55 [39]		1.93 [49]																		

REV: PE0200	SEE SHEET 1 OF 18 FOR NOTES	TO ORDER BURNDY® PRODUCTS CALL UNITED STATES 1-800-346-4175 (LONDONDERRY, NH) CANADA: 1-800-361-6975 (QUEBEC) 1-800-387-6487 (ALL OTHER PROVINCES) FOR PRODUCT INFO: <a href="http://www.burndy.com">http://www.burndy.com</a>	HYLUG™	
			ITEM NO: N/A	CAT. NO: YAV26L-TC-FX-
			DRAWN BY: D FILLION 11/30/92	CHECKER: K HENRY 12/02/92
			DSN APPVL: C PALAGI 12/04/92	MFG APPVL: --
			QA APPVL: A LLOYD 12/07/92	MKT APPVL: T NELSON 12/04/92
			PROD FAM: CM&R Compression	DRAWING NO: SE208001
			PROJECT #: --	SCALE: 1:1
			DOCUMENT TYPE: Sales	REL LEVEL: Released
				SHEET 8 OF 18
				M

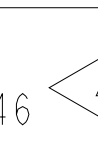
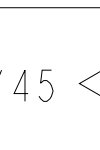

REV	DATE	DESCRIPTION	ECO	BY	C'H'K.
M	05/05/2017 16:12:00 PM	YA32LN516FX135 ADDED AS PER MU	46658	SM	MB

CONDUCTOR			BOLT SIZE	CATALOG NO.	FIG. NO.	DIMENSIONS							BURNDY® INSTALLATION TOOLING (# CRIMPS)																
FLEX	CODE (AWG)	NAVY 				B	C	H	K	L	N	O.D.	T REF.	Z MIN.	DIE INDEX	COLOR CODE	MECHANICAL RATCHET		HYDRAULIC			DIELESS (# CRIMPS)	WIRE STRIP LENGTH						
																	MD7-34R MD6	OUR840	BCT500 Y500CT PAT600	Y750, Y35 Y39, PAT750	Y46 PAT46 			Y45 					
3/0 AWG CLASS G-M DLO (450/24)  95 mm² CLASS 5	3/0 AWG CLASS B,C	150	#10	YAV27LTC10FX	1	1.00 [25]	1.03 [26]	-----		2.03 [51]			.70 [18]	.14 [4]			14	ORANGE	W27RT (2) X27RT (3) W27VT (2)	X27RT (3) W27VT (2)	W27RT (2) X27RT (3) W27VT (2)	U27RT (1)	U27RT (1)	U27RT (1)	MECHANICAL: MY29-11 (1)  HYDRAULIC: Y644M (1) PAT644 (1) Y81KFT (2) PAT81KFT (2) Y4PC834 (2) PAT4PC834 (2)	1"			
				YAV27LTC10FX45	2			1.59 [40]	.21 [5]	1.91 [49]	.25 [6]			.27 [7]															
				YAV27LTC10FX90	3			1.74 [44]		.98 [25]																			
				YAV27LTC14FX	1			-----				2.15 [55]																	
				YAV27LTC14FX45	2			1.59 [40]	.27 [7]	2.04 [52]	.31 [8]				.33 [8]														
				YAV27LTC14FX90	3			1.74 [44]		1.10 [28]																			
				YAV27LTC516FX	1			-----				2.21 [56]																	
				YAV27LTC516FX45	2			1.59 [40]	.33 [8]	2.10 [53]	.34 [9]				.36 [9]														
				YAV27LTC516FX90	3			1.74 [44]		1.17 [30]																			
			YAV27LTC38FX	1			-----				2.34 [59]																		
			YAV27LTC38FX45	2			1.59 [40]	.40 [10]	2.22 [56]	.41 [10]				.42 [11]															
			YAV27LTC38FX90	3			1.74 [44]		1.29 [33]																				
YAV27LTC12FX	1			-----				2.59 [66]																					
YAV27LTC12FX45	2			1.59 [40]	.53 [13]	2.47 [63]	.53 [13]				.55 [14]																		
YAV27LTC12FX90	3			1.74 [44]		1.54 [39]						.70 [18]	.14 [4]																
3/0 AWG CLASS G-M DLO (450/24) 95 mm² CLASS 5	3/0 AWG CLASS B,C	150				1.00 [25]	1.03 [26]	1.74 [44]				.70 [18]	.14 [4]																

REV: PEO200

SEE SHEET 1 OF 18 FOR NOTES

TO ORDER BURNDY® PRODUCTS CALL UNITED STATES 1-800-346-4175 (LONDONDERRY, NH) CANADA: 1-800-361-6975 (QUEBEC) 1-800-387-6487 (ALL OTHER PROVINCES) FOR PRODUCT INFO: <a href="http://www.burndy.com">http://www.burndy.com</a>		HYLUG™ ITEM NO: N/A CAT. NO: YAV27L-TC-FX- DRAWN BY: D FILLION 11/30/92 CHECKER: K HENRY 12/02/92 DSN APPVL: C PALAGI 12/04/92 MFG APPVL: -- QA APPVL: A LLOYD 12/07/92 MKT APPVL: T NELSON 12/04/92 PROD FAM: CM&R Compression PROJECT #: -- DOCUMENT TYPE: Sales REL LEVEL: Released		SCALE: 1:1 DRAWING NO: SE208001 SHEET 9 OF 18 REV: M	
--	--	--	--	---	--



REV	DATE	DESCRIPTION	ECO	BY	CHK.
M	05/05/2017 16:12:00 PM	YA32LN516FX135 ADDED AS PER MU	46658	SM	MB

D	CATALOG NO.	CONDUCTOR			BOLT SIZE	FIG. NO.	DIMENSIONS							BURNDY® INSTALLATION TOOLING (# CRIMPS)											
		FLEX	CODE (AWG)	NAVY			B	C	H	K	L	N	O.D.	T REF.	Z MIN.	DIE INDEX	COLOR CODE	MECHANICAL RATCHET		HYDRAULIC				DIELESS (# CRIMPS)	WIRE STRIP LENGTH
																		MD7-34R MD6	OUR840	BCT500 Y500CT PAT600	Y750, Y35 Y39, PAT750	Y46 PAT46	Y45		
	YAV28LTC14FX	4/0 AWG CLASS G-M DLO (550/24) 120 mm² CLASS 2,5	4/0 AWG CLASS B,C	200	1/4	1	1.03 [26]	-----	-----	2.23 [57]	.31 [8]	.77 [20]	.15 [4]	.33 [8]	15	PURPLE	W28RT (2)	X28RT (3)	W28RT (2)	U28RT UR4205WE (1)	U28RT UR4205WE (1)	U28RT UR4205WE (1)	MECHANICAL: MY29-11 (1)  HYDRAULIC: Y644M (1) PAT644 (1) Y81KFT (2) PAT81KFT (2) Y4PC834 (2) PAT4PC834 (2)	1-1/16"	
	YAV28LTC14FX45						1.14 [29]	1.70 [43]	.27 [7]	2.11 [53]							W28RT (3)	W28VT (2)	X28RT (3)	U28RT UR4205WE (1)	U28RT UR4205WE (1)	U28RT UR4205WE (1)			
	YAV28LTC14FX90						1.83 [47]	1.14 [29]	1.83 [47]	2.29 [58]							W28VT (2)	W28VT (2)	W28VT (2)	U28RT UR4205WE (1)	U28RT UR4205WE (1)	U28RT UR4205WE (1)			
	YAV28LNT516FX	4/0 AWG CLASS G-M DLO (550/24) 120 mm² CLASS 2,5	4/0 AWG CLASS B,C	200	5/16	1	1.03 [26]	-----	-----	2.29 [58]	.34 [9]	.77 [20]	.15 [4]	.36 [9]	15	PURPLE	W28RT (2)	X28RT (3)	W28RT (2)	U28RT UR4205WE (1)	U28RT UR4205WE (1)	U28RT UR4205WE (1)	MECHANICAL: MY29-11 (1)  HYDRAULIC: Y644M (1) PAT644 (1) Y81KFT (2) PAT81KFT (2) Y4PC834 (2) PAT4PC834 (2)	1-1/16"	
	YAV28LNT516FX45							.94 [24]	1.70 [43]	.33 [8]							2.17 [55]	W28RT (3)	W28VT (2)	X28RT (3)	U28RT UR4205WE (1)	U28RT UR4205WE (1)			U28RT UR4205WE (1)
	YAV28LNT516FX90							1.83 [47]	1.21 [31]	1.83 [47]							2.29 [58]	W28VT (2)	W28VT (2)	W28VT (2)	U28RT UR4205WE (1)	U28RT UR4205WE (1)			U28RT UR4205WE (1)
	YAV28LTC516FX	4/0 AWG CLASS G-M DLO (550/24) 120 mm² CLASS 2,5	4/0 AWG CLASS B,C	200	5/16	1	1.03 [26]	-----	-----	2.29 [58]	.34 [9]	.77 [20]	.15 [4]	.36 [9]	15	PURPLE	W28RT (2)	X28RT (3)	W28RT (2)	U28RT UR4205WE (1)	U28RT UR4205WE (1)	U28RT UR4205WE (1)	MECHANICAL: MY29-11 (1)  HYDRAULIC: Y644M (1) PAT644 (1) Y81KFT (2) PAT81KFT (2) Y4PC834 (2) PAT4PC834 (2)	1-1/16"	
	YAV28LTC516FX45							1.14 [29]	1.70 [43]	.33 [8]							2.17 [55]	W28RT (3)	W28VT (2)	X28RT (3)	U28RT UR4205WE (1)	U28RT UR4205WE (1)			U28RT UR4205WE (1)
	YAV28LTC516FX90							1.83 [47]	1.21 [31]	1.83 [47]							2.29 [58]	W28VT (2)	W28VT (2)	W28VT (2)	U28RT UR4205WE (1)	U28RT UR4205WE (1)			U28RT UR4205WE (1)
	YAV28LNT38FX	4/0 AWG CLASS G-M DLO (550/24) 120 mm² CLASS 2,5	4/0 AWG CLASS B,C	200	3/8	1	1.03 [26]	-----	-----	2.42 [61]	.41 [10]	.77 [20]	.15 [4]	.42 [11]	15	PURPLE	W28RT (2)	X28RT (3)	W28RT (2)	U28RT UR4205WE (1)	U28RT UR4205WE (1)	U28RT UR4205WE (1)	MECHANICAL: MY29-11 (1)  HYDRAULIC: Y644M (1) PAT644 (1) Y81KFT (2) PAT81KFT (2) Y4PC834 (2) PAT4PC834 (2)	1-1/16"	
	YAV28LNT38FX45							.94 [24]	1.70 [43]	.41 [10]							2.29 [58]	W28RT (3)	W28VT (2)	X28RT (3)	U28RT UR4205WE (1)	U28RT UR4205WE (1)			U28RT UR4205WE (1)
	YAV28LNT38FX90							1.83 [47]	1.33 [34]	1.83 [47]							2.29 [58]	W28VT (2)	W28VT (2)	W28VT (2)	U28RT UR4205WE (1)	U28RT UR4205WE (1)			U28RT UR4205WE (1)
	YAV28LTC38FX	4/0 AWG CLASS G-M DLO (550/24) 120 mm² CLASS 2,5	4/0 AWG CLASS B,C	200	3/8	1	1.03 [26]	1.14 [29]	-----	2.42 [61]	.41 [10]	.77 [20]	.15 [4]	.42 [11]	15	PURPLE	W28RT (2)	X28RT (3)	W28RT (2)	U28RT UR4205WE (1)	U28RT UR4205WE (1)	U28RT UR4205WE (1)	MECHANICAL: MY29-11 (1)  HYDRAULIC: Y644M (1) PAT644 (1) Y81KFT (2) PAT81KFT (2) Y4PC834 (2) PAT4PC834 (2)	1-1/16"	
	YAV28LTC38FX45							1.14 [29]	1.70 [43]	.41 [10]							2.29 [58]	W28RT (3)	W28VT (2)	X28RT (3)	U28RT UR4205WE (1)	U28RT UR4205WE (1)			U28RT UR4205WE (1)
	YAV28LTC38FX90							1.83 [47]	1.33 [34]	1.83 [47]							2.29 [58]	W28VT (2)	W28VT (2)	W28VT (2)	U28RT UR4205WE (1)	U28RT UR4205WE (1)			U28RT UR4205WE (1)
	YAV28LTC12FX	4/0 AWG CLASS G-M DLO (550/24) 120 mm² CLASS 2,5	4/0 AWG CLASS B,C	200	1/2	1	1.03 [26]	-----	-----	2.67 [68]	.53 [13]	.77 [20]	.15 [4]	.55 [14]	15	PURPLE	W28RT (2)	X28RT (3)	W28RT (2)	U28RT UR4205WE (1)	U28RT UR4205WE (1)	U28RT UR4205WE (1)	MECHANICAL: MY29-11 (1)  HYDRAULIC: Y644M (1) PAT644 (1) Y81KFT (2) PAT81KFT (2) Y4PC834 (2) PAT4PC834 (2)	1-1/16"	
	YAV28LTC12FX45							1.70 [43]	2.54 [65]	.53 [13]							2.54 [65]	W28RT (3)	W28VT (2)	X28RT (3)	U28RT UR4205WE (1)	U28RT UR4205WE (1)			U28RT UR4205WE (1)
	YAV28LTC12FX90							1.83 [47]	1.58 [40]	1.83 [47]							2.54 [65]	W28VT (2)	W28VT (2)	W28VT (2)	U28RT UR4205WE (1)	U28RT UR4205WE (1)			U28RT UR4205WE (1)
	YAV28LTC58FX	4/0 AWG CLASS G-M DLO (550/24) 120 mm² CLASS 2,5	4/0 AWG CLASS B,C	200	5/8	1	1.03 [26]	-----	-----	2.92 [74]	.66 [17]	.77 [20]	.15 [4]	.67 [17]	15	PURPLE	W28RT (2)	X28RT (3)	W28RT (2)	U28RT UR4205WE (1)	U28RT UR4205WE (1)	U28RT UR4205WE (1)	MECHANICAL: MY29-11 (1)  HYDRAULIC: Y644M (1) PAT644 (1) Y81KFT (2) PAT81KFT (2) Y4PC834 (2) PAT4PC834 (2)	1-1/16"	
	YAV28LTC58FX45							1.70 [43]	2.79 [71]	.69 [17]							2.79 [71]	W28RT (3)	W28VT (2)	X28RT (3)	U28RT UR4205WE (1)	U28RT UR4205WE (1)			U28RT UR4205WE (1)
	YAV28LTC58FX90							1.83 [47]	1.83 [46]	1.83 [47]							2.79 [71]	W28VT (2)	W28VT (2)	W28VT (2)	U28RT UR4205WE (1)	U28RT UR4205WE (1)			U28RT UR4205WE (1)
	YAV28LTC34FX	4/0 AWG CLASS G-M DLO (550/24) 120 mm² CLASS 2,5	4/0 AWG CLASS B,C	200	3/4	1	1.03 [26]	-----	-----	3.11 [79]	.75 [19]	.77 [20]	.15 [4]	.77 [19]	15	PURPLE	W28RT (2)	X28RT (3)	W28RT (2)	U28RT UR4205WE (1)	U28RT UR4205WE (1)	U28RT UR4205WE (1)	MECHANICAL: MY29-11 (1)  HYDRAULIC: Y644M (1) PAT644 (1) Y81KFT (2) PAT81KFT (2) Y4PC834 (2) PAT4PC834 (2)	1-1/16"	
	YAV28LTC34FX45							1.70 [43]	2.98 [76]	.81 [21]							2.98 [76]	W28RT (3)	W28VT (2)	X28RT (3)	U28RT UR4205WE (1)	U28RT UR4205WE (1)			U28RT UR4205WE (1)
	YAV28LTC34FX90							1.83 [47]	2.02 [51]	1.83 [47]							2.98 [76]	W28VT (2)	W28VT (2)	W28VT (2)	U28RT UR4205WE (1)	U28RT UR4205WE (1)			U28RT UR4205WE (1)

SEE SHEET 1 OF 18 FOR NOTES

TO ORDER BURNDY® PRODUCTS CALL		HYLUG™	
UNITED STATES 1-800-346-4175 (LONDONDERRY, NH)		ITEM NO: N/A	
CANADA: 1-800-361-6975 (QUEBEC) 1-800-387-6487 (ALL OTHER PROVINCES)		CAT. NO: YAV28L - (TABLE)	
FOR PRODUCT INFO: <a href="http://www.burndy.com">http://www.burndy.com</a>		DRAWN BY: D FILLION 11/30/92	
		CHECKER: K HENRY 12/02/92	
		DSN APPVL: C PALAGI 12/04/92	
		MFG APPVL: -- --	
		QA APPVL: A LLOYD 12/02/92	
		MKT APPVL: T NELSON 12/04/92	
		SCALE: 1:1	
		PROJECT #: -- SIZE	
		DOCUMENT TYPE: Sales	
		REL LEVEL: Released	
		DRAWING NO: SE208001	
		REV: M	
		SHEET 10 OF 18	

REV: PEO200

REV	DATE	DESCRIPTION	ECO	BY	C'H'K.
M	05/05/2017 16:12:00 PM	YA32LN516FX135 ADDED AS PER MU	46658	SM	MB

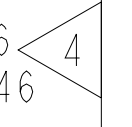
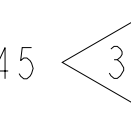
CONDUCTOR			BOLT SIZE	CATALOG NO.	FIG. NO.	DIMENSIONS							BURNDY® INSTALLATION TOOLING (# CRIMPS)														
FLEX	CODE (AWG)	NAVY 				B	C	H	K	L	N	O.D.	T REF.	Z MIN.	DIE INDEX	COLOR CODE	MECHANICAL RATCHET		HYDRAULIC			DIELESS (# CRIMPS)	WIRE STRIP LENGTH				
																	MD7-34R MD6	OUR840	BCT500 Y500CT PAT600	Y750, Y35 Y39, PAT750	Y46 PAT46 			Y45 			
250 FLEX CLASS G: 259 STR	-----	-----	5/16	YA30LTC516FX	1	1.03 [26]	1.20 [30]	-----		2.31 [59]			.81 [21]	.16 [4]		16	YELLOW	W29VT (2)	X29VT (2)	W29VT (2)	U29RT (1)	U29RT (1)	U29RT (1)	HYDRAULIC: Y644M (1) PAT644 (1) Y81KFT (2) PAT81KFT (2) Y4PC834 (2) PAT4PC834 (2)	1-1/16"		
				YA30LTC516FX45	2			1.75 [44]	.33 [8]	2.22 [56]	.34 [9]																
				YA30LTC516FX90	3			1.89 [48]		1.24 [31]																	
CLASS H: 427 STR	-----	-----	3/8	YA30LTC38FX	1			-----		2.44 [62]													HYDRAULIC: Y644M (1) PAT644 (1) Y81KFT (2) PAT81KFT (2) Y4PC834 (2) PAT4PC834 (2)	1-1/16"			
				YA30LTC38FX45	2			1.75 [44]	.40 [10]	2.35 [60]	.41 [10]																
				YA30LTC38FX90	3			1.89 [48]		1.36 [35]																	
250 FLEX CLASS G: 259 STR	-----	-----	1/2	YA30LTC12FX	1			-----		2.69 [68]													HYDRAULIC: Y644M (1) PAT644 (1) Y81KFT (2) PAT81KFT (2) Y4PC834 (2) PAT4PC834 (2)	1-1/16"			
				YA30LTC12FX45	2			1.75 [44]	.53 [13]	2.60 [66]	.53 [13]																
				YA30LTC12FX90	3			1.89 [48]		1.61 [41]																	
CLASS H: 427 STR	-----	-----	5/8	YA30LTC58FX	1			-----		2.94 [75]													HYDRAULIC: Y644M (1) PAT644 (1) Y81KFT (2) PAT81KFT (2) Y4PC834 (2) PAT4PC834 (2)	1-1/16"			
				YA30LTC58FX45	2			1.75 [44]	.69 [17]	2.85 [72]	.66 [17]																
				YA30LTC58FX90	3			1.89 [48]		1.86 [47]																	
250 FLEX CLASS G: 259 STR	-----	-----	3/4	YA30LTC34FX	1			-----		3.12 [79]													HYDRAULIC: Y644M (1) PAT644 (1) Y81KFT (2) PAT81KFT (2) Y4PC834 (2) PAT4PC834 (2)	1-1/16"			
				YA30LTC34FX45	2			1.75 [44]	.81 [21]	3.04 [77]	.75 [19]																
				YA30LTC34FX90	3	1.03 [26]	1.20 [30]	1.89 [48]		2.05 [52]																	

SEE SHEET 1 OF 18 FOR NOTES

TO ORDER BURNDY® PRODUCTS CALL

UNITED STATES  
1-800-346-4175 (LONDONDERRY, NH)

CANADA:  
1-800-361-6975 (QUEBEC)  
1-800-387-6487 (ALL OTHER PROVINCES)

FOR PRODUCT INFO: <http://www.burndy.com>

HYLUG™

ITEM NO: N/A

CAT. NO: YA30L-TC-FX-

DRAWN BY: D FILLION 11/30/92

CHECKER: K HENRY 12/02/92

DSN APPVL: C PALAGI 12/04/92

MFG APPVL: --

QA APPVL: A LLOYD 12/07/92

MKT APPVL: T NELSON 12/04/92

PROD FAM: CM&R Compression

PROJECT #: --

DOCUMENT TYPE: Sales

REL LEVEL: Released

SCALE: 1:1

DRAWING NO: SE208001

SHEET 11 OF 18

REV: M

REV	DATE	DESCRIPTION	ECO	BY	C'K.
M	05/05/2017 16:12:00 PM	YA32LN516FX135 ADDED AS PER MU	46658	SM	MB

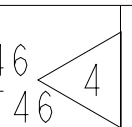
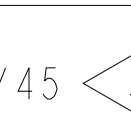
CONDUCTOR			BOLT SIZE	CATALOG NO.	FIG. NO.	DIMENSIONS							BURNDY® INSTALLATION TOOLING (# CRIMPS)																
FLEX	CODE (AWG)	NAVY 				B	C	H	K	L	N	O.D	T REF.	Z MIN.	DIE INDEX	COLOR CODE	MECHANICAL RATCHET		HYDRAULIC			DIELESS (# CRIMPS)	WIRE STRIP LENGTH						
																	MD7-34R MD6	OUR840	BCT500 Y500CT PAT600	Y750, Y35 Y39, PAT750	Y46 PAT46 			Y45 					
250 FLEX CLASS I, K, M DLO (637/24) 150 mm² CLASS 5	-----	-----	1/4	YA31LTC14FX	1	1.06 [27]	1.29 [33]	-----		2.31 [59]			.88 [22]	.18 [4]			17 OR 298	WHITE	W30VT (2)	X30VT (2)	W30VT (2)	U30RT (2)	U30RT (2)	U30RT (2)		1-1/8"			
				YA31LTC14FX45	2			1.85 [47]	.27 [7]	2.23 [57]	.31 [8]																		
				YA31LTC14FX90	3			1.98 [50]		1.19 [30]																			
			5/16	YA31LTC516FX	1			-----			2.37 [60]																		
				YA31LTC516FX45	2			1.85 [47]	.33 [8]	2.30 [58]	.34 [9]																		
				YA31LTC516FX90	3			1.98 [50]		1.27 [32]																			
			3/8	YA31LTC38FX	1			-----			2.50 [64]																		
				YA31LTC38FX45	2			1.85 [47]	.40 [10]	2.42 [61]	.41 [10]																		
				YA31LTC38FX90	3			1.98 [50]		1.40 [36]																			
			1/2	YA31LNT12FX	1			-----			2.75 [70]																		
				YA31LNT12FX45	2			.96 [24]	1.85 [47]	.53 [13]	2.67 [68]	.53 [13]																	
				YA31LNT12FX90	3			1.98 [50]		1.65 [42]																			
1/2	YA31LTC12FX	1			1.29 [33]	-----		2.75 [70]																					
	YA31LTC12FX45	2				1.85 [47]	.53 [13]	2.67 [68]	.53 [13]																				
	YA31LTC12FX90	3			1.98 [50]		1.65 [42]																						
5/8	YA31LTC58FX	1			-----			3.00 [76]																					
	YA31LTC58FX45	2			1.85 [47]	.69 [17]	2.92 [74]	.66 [17]																					
	YA31LTC58FX90	3			1.98 [50]		1.90 [48]																						
3/4	YA31LTC34FX	1			-----			3.19 [81]																					
	YA31LTC34FX45	2			1.85 [47]	.81 [21]	3.11 [79]	.75 [19]																					
	YA31LTC34FX90	3			1.06 [27]	1.29 [33]	1.98 [50]		2.09 [53]			.88 [22]	.18 [4]			17 OR 298	WHITE	W30VT (2)	X30VT (2)	W30VT (2)	U30RT (2)	U30RT (2)	U30RT (2)		1-1/8"				

HYDRAULIC:  
Y644M (1)  
PAT644 (1)  
Y81KFT (2)  
PAT81KFT (2)  
Y4PC834 (2)  
PAT4PC834 (2)

REV: PEO200

SEE SHEET 1 OF 18 FOR NOTES

TO ORDER BURNDY® PRODUCTS CALL		HYLUG™	
UNITED STATES 1-800-346-4175 (LONDONDERRY, NH)		ITEM NO: N/A	
CANADA: 1-800-361-6975 (QUEBEC) 1-800-387-6487 (ALL OTHER PROVINCES)		CAT. NO: YA31L-TC-FX-	
FOR PRODUCT INFO: <a href="http://www.burndy.com">http://www.burndy.com</a>		DRAWN BY: D FILLION 12/01/92	
		CHECKER: K HENRY 12/02/92	
		DSN APPVL: C PALAGI 12/04/92	
		MFG APPVL: --	
		QA APPVL: A LLOYD 12/07/92	
		MKT APPVL: T NELSON 12/04/92	
		PROD FAM: CM&R Compression	
		DRAWING NO: SE208001	
		PROJECT #: --	
		DOCUMENT TYPE: Sales	
		REL LEVEL: Released	
		SCALE: 1:1	
		SHEET 12 OF 18	





REV	DATE	DESCRIPTION	ECO	BY	CHK.
M	05/05/2017 16:12:00 PM	YA32LN516FX135 ADDED AS PER MU	46658	SM	MB

D	CATALOG NO.	FIG. NO.	CONDUCTOR			BOLT SIZE	DIMENSIONS							BURNDY® INSTALLATION TOOLING (# CRIMPS)										D																																					
			FLEX	CODE (AWG)	NAVY		B	C	H	K DIA.	L	N	O.D.	T REF.	Z MIN.	DIE INDEX	COLOR CODE	MECHANICAL RATCHET		HYDRAULIC					DIELESS (# CRIMPS)	WIRE STRIP LENGTH																																			
																		MD7-34R MD6	OUR840	BCT500 Y500CT PAT600	Y750, Y35 Y39, PAT750	Y46 PAT46	Y45																																						
	YA32LNT516FX	1	313.1 Kcmil DLO (775/24) (300 Kcmil FLEX)  185 mm² CLASS 5	-----	-----	5/16 [M8]	1.19 [30]	.96 [24]	-----	.33 [8]	2.65 [65]	.34 [9]	.95 [24]	.19 [5]	.36 [9]	18 OR 324	RED	W31VT (2)	X31VT (2)	W31VT (2)	U31RT (2)	U31RT (2)	U31RT (2)	HYDRAULIC: Y644M (1) BAT644M(1) PAT644M(1) PAT644 (1) Y81KFT (2) PAT81KFT (2) Y4PC834 (2) PAT4PC834 (2)	1-1/4"																																				
	YA32LNT516FX45	2					2.03 [52]	2.46 [62]	.33 [8]		.96 [24]							.41 [10]	.41 [10]	.42 [11]	W31VT (2)	X31VT (2)	W31VT (2)			U31RT (2)	U31RT (2)	U31RT (2)																																	
	YA32LNT516FX90	3					2.19 [56]	2.19 [56]																					.33 [8]	.96 [24]	.41 [10]	.41 [10]	.42 [11]	W31VT (2)	X31VT (2)	W31VT (2)	U31RT (2)	U31RT (2)	U31RT (2)																						
	YA32LN516FX135	4					1.40 [36]	2.75 [70]		.33 [8]																														.96 [24]	.41 [10]	.41 [10]	.42 [11]	W31VT (2)	X31VT (2)	W31VT (2)	U31RT (2)	U31RT (2)	U31RT (2)												
	YA32LNT38FX	1					-----	2.68 [68]	.33 [8]																																									.96 [24]	.41 [10]	.41 [10]	.42 [11]	W31VT (2)	X31VT (2)	W31VT (2)	U31RT (2)	U31RT (2)	U31RT (2)		
	YA32LNT38FX45	2					2.03 [52]	2.58 [66]																					.33 [8]																															.96 [24]	.41 [10]
	YA32LNT38FX90	3				2.19 [56]	1.45 [37]	.33 [8]		.96 [24]		.41 [10]	.41 [10]	.42 [11]	W31VT (2)	X31VT (2)	W31VT (2)																																												
	YA32LTC38FX	1				1.40 [36]	2.68 [68]		.33 [8]		.96 [24]							.41 [10]	.41 [10]	.42 [11]	W31VT (2)	X31VT (2)	W31VT (2)			U31RT (2)	U31RT (2)	U31RT (2)																																	
	YA32LTC38FX45	2				2.03 [52]	2.58 [66]																						.33 [8]	.96 [24]	.41 [10]	.41 [10]	.42 [11]	W31VT (2)	X31VT (2)	W31VT (2)	U31RT (2)	U31RT (2)	U31RT (2)																						
	YA32LTC38FX90	3				2.19 [56]	1.45 [37]	.33 [8]																																.96 [24]	.41 [10]	.41 [10]	.42 [11]	W31VT (2)	X31VT (2)	W31VT (2)	U31RT (2)	U31RT (2)	U31RT (2)												
	YA32LTC12FX	1				-----	2.93 [74]		.33 [8]																																									.96 [24]	.41 [10]	.41 [10]	.42 [11]	W31VT (2)	X31VT (2)	W31VT (2)	U31RT (2)	U31RT (2)	U31RT (2)		
	YA32LTC12FX45	2				2.03 [52]	2.83 [72]																						.33 [8]																															.96 [24]	.41 [10]
	YA32LTC12FX90	3				2.19 [56]	1.70 [43]	.33 [8]		.96 [24]		.41 [10]	.41 [10]	.42 [11]	W31VT (2)	X31VT (2)	W31VT (2)																																												
	YA32LTC58FX	1				-----	3.18 [81]		.33 [8]		.96 [24]							.41 [10]	.41 [10]	.42 [11]	W31VT (2)	X31VT (2)	W31VT (2)			U31RT (2)	U31RT (2)	U31RT (2)																																	
	YA32LTC58FX45	2				2.03 [52]	3.08 [78]																						.33 [8]	.96 [24]	.41 [10]	.41 [10]	.42 [11]	W31VT (2)	X31VT (2)	W31VT (2)	U31RT (2)	U31RT (2)	U31RT (2)																						
	YA32LTC58FX90	3				2.19 [56]	1.95 [49]	.33 [8]																																.96 [24]	.41 [10]	.41 [10]	.42 [11]	W31VT (2)	X31VT (2)	W31VT (2)	U31RT (2)	U31RT (2)	U31RT (2)												
	YA32LTC78FX	1				-----	3.62 [92]		.33 [8]																																									.96 [24]	.41 [10]	.41 [10]	.42 [11]	W31VT (2)	X31VT (2)	W31VT (2)	U31RT (2)	U31RT (2)	U31RT (2)		
	YA32LTC78FX45	2				2.03 [52]	3.52 [89]																						.33 [8]																															.96 [24]	.41 [10]
	YA32LTC78FX90	3	2.19 [56]	2.38 [60]	.33 [8]	.96 [24]	.41 [10]	.41 [10]		.42 [11]		W31VT (2)	X31VT (2)	W31VT (2)	U31RT (2)	U31RT (2)	U31RT (2)																																												

A	SEE SHEET 1 OF 18 FOR NOTES	TO ORDER BURNDY® PRODUCTS CALL		HYLUG™		8 BURNDY	
		UNITED STATES		ITEM NO:	N/A		
		1-800-346-4175 (LONDONDERRY, NH)		CAT. NO:	YA32L- (TABLE)		
		CANADA:		DRAWN BY:	D FILLION 12/01/92		
		1-800-361-6975 (QUEBEC)		CHECKER:	K HENRY 12/02/92		
1-800-387-6487 (ALL OTHER PROVINCES)		DSN APPVL:	C PALAGI 12/04/92				
FOR PRODUCT INFO: <a href="http://www.burndy.com">http://www.burndy.com</a>		MFG APPVL:	--				
		GA APPVL:	A LLOYD 12/07/92				
		MKT APPVL:	T NELSON 12/04/92				
		PROD FAM:	CM&R Compression	DRAWING NO:	REV		
		PROJECT #:	--	SIZE	SE208001		
		DOCUMENT TYPE:	Sales		M		
		REL LEVEL:	Released		SHEET 13 OF 18		

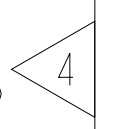
REV	DATE	DESCRIPTION	ECO	BY	C'H'K.
M	05/05/2017 16:12:00 PM	YA32LN516FX135 ADDED AS PER MU	46658	SM	MB

CONDUCTOR			BOLT SIZE	CATALOG NO.	FIG. NO.	DIMENSIONS							BURNDY® INSTALLATION TOOLING (# CRIMPS)															
FLEX	CODE (AWG)	NAVY 				B	C	H	K	L	N	O.D.	T REF.	Z MIN.	DIE INDEX	COLOR CODE	MECHANICAL RATCHET		HYDRAULIC			DIELESS (# CRIMPS)	WIRE STRIP LENGTH					
															MD7-34R MD6	OUR840	BCT500 Y500CT PAT600	Y750, Y35 Y39, PAT750	Y46 PAT46 	Y45 								
373.7 Kcmil DLO (925/24) (350 Kcmil/FLEX) 240 mm² CLASS 5	----- ↑	----- ↑	5/16	YA34LTC516FX	1	1.27 [32]	1.55 [39]	-----		2.74 [70]			1.06 [27]	.23 [6]			19 OR 470	BLUE	W32VT (2)	X32VT (2)	W32VT (2)	U32RT (2)	U32RT (2)	U32RT (2)	HYDRAULIC: Y644M (1) PAT644 (1) Y81KFT (2) PAT81KFT (2) Y4PC834 (2) PAT4PC834 (2)	1-5/16"		
				YA34LTC516FX45	2	↑	↑	2.24 [57]	.33 [8]	2.66 [67]	.34 [9]	↑	↑	.36 [9]	↑	↑	↑	↑	↑	↑	↑	↑	↑	↑			↑	↑
				YA34LTC516FX90	3			2.41 [61]		1.40 [36]																		
373.7 Kcmil DLO (925/24) (350 Kcmil/FLEX) 240 mm² CLASS 5	----- ↑	----- ↑	3/8	YA34LTC38FX	1	↑	↑	-----		2.87 [73]			↑	↑	↑	↑	↑	↑	↑	↑	↑	↑	↑	↑	↑			
				YA34LTC38FX45	2			2.24 [57]	.40 [10]	2.78 [70]	.41 [10]	.42 [11]																
				YA34LTC38FX90	3			2.41 [61]		1.52 [39]																		
373.7 Kcmil DLO (925/24) (350 Kcmil/FLEX) 240 mm² CLASS 5	----- ↑	----- ↑	1/2	YA34LTC12FX	1	↑	↑	-----		3.12 [79]			↑	↑	↑	↑	↑	↑	↑	↑	↑	↑	↑	↑	↑			
				YA34LTC12FX45	2			2.24 [57]	.53 [13]	3.03 [76]	.53 [13]	.55 [14]																
				YA34LTC12FX90	3			2.41 [61]		1.77 [45]																		
373.7 Kcmil DLO (925/24) (350 Kcmil/FLEX) 240 mm² CLASS 5	----- ↑	----- ↑	5/8	YA34LTC58FX	1	↓	↓	-----		3.37 [86]			↓	↓	↓	↓	↓	↓	↓	↓	↓	↓	↓	↓	↓			
				YA34LTC58FX45	2			2.24 [57]	.69 [18]	3.28 [83]	.66 [17]	.67 [17]																
				YA34LTC58FX90	3			1.27 [32]	1.55 [39]	2.41 [61]		2.02 [52]															1.06 [27]	.23 [6]

SEE SHEET 1 OF 18 FOR NOTES

TO ORDER BURNDY® PRODUCTS CALL		HYLUG™	
UNITED STATES 1-800-346-4175 (LONDONDERRY, NH)		ITEM NO: N/A	
CANADA: 1-800-361-6975 (QUEBEC) 1-800-387-6487 (ALL OTHER PROVINCES)		CAT. NO: YA34L-TC-FX-	
FOR PRODUCT INFO: <a href="http://www.burndy.com">http://www.burndy.com</a>		DRAWN BY: D FILLION 12/01/92	
		CHECKER: K HENRY 12/02/92	
		DSN APPVL: C PALAGI 12/04/92	
		MFG APPVL: -- --	
		QA APPVL: A LLOYD 12/07/92	
		MKT APPVL: -- --	
		SCALE: 1:1	
		PROD FAM: CM&R Compression	
		DRAWING NO	
		PROJECT #: --	
		SIZE	
		DOCUMENT TYPE: Sales	
		REL LEVEL: Released	
		DRAWING NO: SE208001	
		REV: M	
		SHEET 14 OF 18	

REV: PEO200

REV	DATE	DESCRIPTION	ECO	BY	C'H'K.
M	05/05/2017 16:12:00 PM	YA32LN516FX135 ADDED AS PER MU	46658	SM	MB

D

D

C

C

B

B

A

A

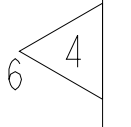
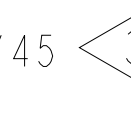
CATALOG NO.	CONDUCTOR			BOLT SIZE	FIG. NO.	DIMENSIONS							BURNDY® INSTALLATION TOOLING (# CRIMPS)								
	FLEX	CODE (AWG)	NAVY 			B	C	H	K	L	N	O.D.	T REF.	Z MIN.	DIE INDEX	COLOR CODE	HYDRAULIC			DIELESS (# CRIMPS)	WIRE STRIP LENGTH
																	Y750 Y35 Y39, PAT750	Y46 PAT46 	Y45 		
YA36LTC38FX	444.4 Kcmil DLO (1100/24) (450 Kcmil FLEX)	-----	-----	3/8	1.38 [35]	1.74 [44]	-----	.41 [10]	3.23 [82]	.50 [13]	1.19 [31]	.27 [7]	.51 [13]	20 OR 299	BROWN	U34RT (2)	U34RT (2)	U34RT (2)	HYDRAULIC: Y644M (1) PAT644 (1) Y81KFT (2) PAT81KFT (2) Y4PC834 (2) PAT4PC834 (2)	1-3/8"	
YA36LTC38FX45							2.48 [63]		3.20 [81]												
YA36LTC38FX90							2.68 [68]		1.80 [46]												
YA36LTC12FX	444.4 Kcmil DLO (1100/24) (450 Kcmil FLEX)	-----	-----	1/2	1.38 [35]	1.74 [44]	-----	.53 [13]	3.29 [84]	.53 [13]	1.19 [31]	.27 [7]	.55 [14]	20 OR 299	BROWN	U34RT (2)	U34RT (2)	U34RT (2)	HYDRAULIC: Y644M (1) PAT644 (1) Y81KFT (2) PAT81KFT (2) Y4PC834 (2) PAT4PC834 (2)	1-3/8"	
YA36LTC12FX45							2.48 [63]		3.26 [83]												
YA36LTC12FX90							2.68 [68]		1.86 [47]												
YA36LTC58FX	444.4 Kcmil DLO (1100/24) (450 Kcmil FLEX)	-----	-----	5/8	1.38 [35]	1.74 [44]	-----	.69 [17]	3.54 [90]	.66 [17]	1.19 [31]	.27 [7]	.67 [17]	20 OR 299	BROWN	U34RT (2)	U34RT (2)	U34RT (2)	HYDRAULIC: Y644M (1) PAT644 (1) Y81KFT (2) PAT81KFT (2) Y4PC834 (2) PAT4PC834 (2)	1-3/8"	
YA36LTC58FX45							2.48 [63]		3.51 [89]												
YA36LTC58FX90							2.68 [68]		2.11 [54]												
YA36LTC78FX	444.4 Kcmil DLO (1100/24) (450 Kcmil FLEX)	-----	-----	7/8	1.38 [35]	1.74 [44]	-----	.94 [24]	3.98 [101]	.88 [23]	1.19 [31]	.27 [7]	.89 [23]	20 OR 299	BROWN	U34RT (2)	U34RT (2)	U34RT (2)	HYDRAULIC: Y644M (1) PAT644 (1) Y81KFT (2) PAT81KFT (2) Y4PC834 (2) PAT4PC834 (2)	1-3/8"	
YA36LTC78FX							2.48 [63]		3.98 [101]												

SEE SHEET 1 OF 18 FOR NOTES

TO ORDER BURNDY® PRODUCTS CALL		HYLUG™	
UNITED STATES 1-800-346-4175 (LONDONDERRY, NH)		ITEM NO: N/A	
CANADA: 1-800-361-6975 (QUEBEC) 1-800-387-6487 (ALL OTHER PROVINCES)		CAT. NO: YA36L-TC--FX- (TABLE)	
FOR PRODUCT INFO: <a href="http://www.burndy.com">http://www.burndy.com</a>		DRAWN BY: D FILLION 12/01/92	
		CHECKER: K HENRY 12/02/92	
		DSN APPVL: C PALAGI 12/04/92	
		MFG APPVL: --	
		QA APPVL: A LLOYD 12/07/92	
		MKT APPVL: T NELSON 12/07/92	
		PROD FAM: CM&R Compression	
		DRAWING NO	
		PROJECT #: --	
		SIZE	
		DOCUMENT TYPE: Sales	
		REL LEVEL: Released	
		SCALE: 1:1	
		DRAWING NO	
		REV	
		SE208001	
		M	
		SHEET 15 OF 18	



REV: PEO200

REV	DATE	DESCRIPTION	ECO	BY	CHK.
M	05/05/2017 16:12:00 PM	YA32LN516FX135 ADDED AS PER MU	46658	SM	MB

D	CONDUCTOR			BOLT SIZE	CATALOG NO.	FIG. NO.	DIMENSIONS							BURNDY® INSTALLATION TOOLING (# CRIMPS)					D								
	FLEX	CODE (AWG)	NAVY				B	C	H	K	L	N	O.D.	T REF.	Z MIN.	DIE INDEX	COLOR CODE	HYDRAULIC			DIELESS (# CRIMPS)	WIRE STRIP LENGTH					
																		Y750 Y35 Y39, PAT750		Y46 PAT46			Y45				
C	535.3 Kcmil DLO (1325/24) (500 Kcmil FLEX)	-----	-----	5/16	YA38LTC516FX	1	1.45 [37]	1.84 [47]	-----		3.03 [77]		1.25 [32]	.27 [7]				L99	PINK	U38XRT UR4140WE (2)	U38XRT UR4140WE (2)	U38XRT UR4140WE (2)	HYDRAULIC: Y644M (1) PAT644 (1) Y81KFT (2) PAT81KFT (3) Y4PC834 (3) PAT4PC834 (3)	1-7/16"			
					YA38LTC516FX45	2		2.60 [66]	.33 [8]	2.97 [75]	.34 [9]																
					YA38LTC516FX90	3		2.80 [71]		1.52 [39]																	
					YA38LTC38FX	1		-----		3.34 [85]																	
					YA38LTC38FX45	2		2.60 [66]	.40 [10]	3.29 [84]	.50 [13]																
					YA38LTC38FX90	3		2.80 [71]		1.83 [46]																	
	535.3 Kcmil DLO (1325/24) (500 Kcmil FLEX)	-----	-----	3/8	YA38LTC12FX	1	-----		3.41 [87]																		
					YA38LTC12FX45	2	2.60 [66]	.53 [13]	3.35 [85]	.53 [13]																	
					YA38LTC12FX90	3	2.80 [71]		1.90 [48]																		
					YA38LTC58FX	1	-----		3.66 [93]																		
					YA38LTC58FX45	2	2.60 [66]	.69 [17]	3.60 [91]	.66 [17]																	
					YA38LTC58FX90	3	1.45 [37]	1.84 [47]	2.80 [71]		2.15 [55]																
300 mm <sup>2</sup> CLASS 5	-----	-----	5/8	YA38LTC58FX	1	-----		3.66 [93]																			
				YA38LTC58FX45	2	2.60 [66]	.69 [17]	3.60 [91]	.66 [17]																		
				YA38LTC58FX90	3	1.45 [37]	1.84 [47]	2.80 [71]		2.15 [55]																	
				U38XRT UR4140WE (2)																							
				U38XRT UR4140WE (2)																							
				U38XRT UR4140WE (2)																							

B

A

SEE SHEET 1 OF 18 FOR NOTES

TO ORDER BURNDY® PRODUCTS CALL  
 UNITED STATES  
 1-800-346-4175 (LONDONDERRY, NH)  
 CANADA:  
 1-800-361-6975 (QUEBEC)  
 1-800-387-6487 (ALL OTHER PROVINCES)  
 FOR PRODUCT INFO: <http://www.burndy.com>

HYLUG™

ITEM NO:	N/A
CAT. NO:	YA38L-TC-FX-
DRAWN BY:	D FILLION 12/01/92
CHECKER:	K HENRY 12/02/92
DSN APPVL:	C PALAGI 12/04/92
MFG APPVL:	--
QA APPVL:	A LLOYD 12/07/92
MKT APPVL:	T NELSON 12/04/92
PROD FAM:	CM&R Compression
PROJECT #:	--
DOCUMENT TYPE:	Sales
REL LEVEL:	Released



SCALE: 1:1  
 DRAWING NO: SE208001  
 SHEET 16 OF 18



REV	DATE	DESCRIPTION	ECO	BY	C.H.K.
M	05/05/2017 16:12:00 PM	YA32LN516FX135 ADDED AS PER MU	46658	SM	MB

D  
C  
B  
A

D  
C  
B  
A

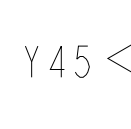

CONDUCTOR			BOLT SIZE	CATALOG NO.	FIG. NO.	DIMENSIONS							BURNDY® INSTALLATION TOOLING (# CRIMPS)											
FLEX	CODE (AWG)	NAVY 				B	C	H	K	L	N	O.D.	T REF.	Z MIN.	DIE INDEX	COLOR CODE	HYDRAULIC			DIELESS (# CRIMPS)	WIRE STRIP LENGTH			
																	Y750 Y35 Y39, PAT750	Y46 PAT46 	Y45 					
646 Kcmil DLO (1600/24) (650 Kcmil FLEX)  400 mm² CLASS 5	↑	↑	5/16	YA40LTC516FX	1	1.42 [36]	1.98 [50]	-----		3.05 [77]			1.35 [34]	.30 [8]		24	BLACK	U39RT (2)	U39RT (2)	U39RT (2)		1-5/16"		
				YA40LTC516FX45	2	↑	↑	2.71 [69]	.33 [8]	3.06 [78]	.34 [9]	↑	↑	↑	↑	↑	↑	↑	↑	↑	↑	↑	↑	↑
				YA40LTC516FX90	3	↑	↑	2.89 [73]		1.59 [40]		↑	↑	↑	↑	↑	↑	↑	↑	↑	↑	↑	↑	↑
646 Kcmil DLO (1600/24) (650 Kcmil FLEX)  400 mm² CLASS 5	↑	↑	3/8	YA40LTC38FX	1	↑	↑	-----		3.38 [86]			↑	↑	↑	24	BLACK	U39RT (2)	U39RT (2)	U39RT (2)	HYDRAULIC: Y644M (1) PAT644 (1) Y81KFT (2) PAT81KFT (3) Y4PC834 (3) PAT4PC834 (3)	1-5/16"		
				YA40LTC38FX45	2			2.71 [69]	.40 [10]	3.38 [86]	.50 [13]	.52 [13]												
				YA40LTC38FX90	3			2.89 [73]		1.91 [49]														
646 Kcmil DLO (1600/24) (650 Kcmil FLEX)  400 mm² CLASS 5	↑	↑	1/2	YA40LTC12FX	1	↑	↑	-----		3.43 [87]			↑	↑	↑	24	BLACK	U39RT (2)	U39RT (2)	U39RT (2)	HYDRAULIC: Y644M (1) PAT644 (1) Y81KFT (2) PAT81KFT (3) Y4PC834 (3) PAT4PC834 (3)	1-5/16"		
				YA40LTC12FX45	2			2.71 [69]	.53 [13]	3.44 [87]	.53 [13]	.55 [14]												
				YA40LTC12FX90	3			2.89 [73]		1.96 [50]														
646 Kcmil DLO (1600/24) (650 Kcmil FLEX)  400 mm² CLASS 5	↑	↑	5/8	YA40LTC58FX	1	↑	↑	-----		3.68 [93]			↑	↑	↑	24	BLACK	U39RT (2)	U39RT (2)	U39RT (2)	HYDRAULIC: Y644M (1) PAT644 (1) Y81KFT (2) PAT81KFT (3) Y4PC834 (3) PAT4PC834 (3)	1-5/16"		
				YA40LTC58FX45	2			2.71 [69]	.69 [17]	3.69 [94]	.66 [17]	.67 [17]												
				YA40LTC58FX90	3			2.89 [73]		2.21 [56]														

SEE SHEET 1 OF 18 FOR NOTES

TO ORDER BURNDY® PRODUCTS CALL		HYLUG™	
UNITED STATES 1-800-346-4175 (LONDONDERRY, NH)		ITEM NO: N/A	CAT. NO: YA40L-TC-FX-
CANADA: 1-800-361-6975 (QUEBEC) 1-800-387-6487 (ALL OTHER PROVINCES)		DRAWN BY: D FILLION 12/01/91	CHECKER: K HENRY 12/02/92
FOR PRODUCT INFO: <a href="http://www.burndy.com">http://www.burndy.com</a>		DSN APPVL: C PALAGI 12/04/92	MFG APPVL: --
		GA APPVL: A LLOYD 12/07/92	MKT APPVL: T NELSON 12/04/92
		PROD FAM: CM&R Compression	DRAWING NO: SE208001
		PROJECT #: --	SCALE: 1:1
		DOCUMENT TYPE: Sales	REV: M
		REL LEVEL: Released	SHEET 17 OF 18

REV: PEO200

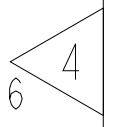
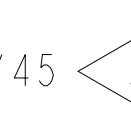
REV	DATE	DESCRIPTION	ECO	BY	C.H.K.
M	05/05/2017 16:12:00 PM	YA32LN516FX135 ADDED AS PER MU	46658	SM	MB

CATALOG NO.	FIG. NO.	CONDUCTOR			BOLT SIZE	DIMENSIONS								BURNDY® INSTALLATION TOOLING (# CRIMPS)												
		FLEX	CODE (AWG)	NAVY 		B	C	H	K	L	N	O.D.	T REF.	Z MIN.	DIE INDEX	COLOR CODE	HYDRAULIC			DIELESS (# CRIMPS)	WIRE STRIP LENGTH					
																	Y750 Y35 Y39 BAT750 PAT750	Y46 PAT46 	Y45 							
YA44LTC12FX	1	777.7 Kcmil DLO (1925/24) (750 Kcmil FLEX)	500 mm <sup>2</sup> CLASS 5		1/2 [M12]	1.65 [42]	2.19 [56]	-----	.53 [13]	3.79 [96]	.53 [13]	1.50 [38]	.33 [8]	.55 [14]	L115	YELLOW	U44XRT UR4141WE (2)	U44XRT UR4141WE (2)	U44XRT UR4141WE (2)	HYDRAULIC: Y644M (1) PAT644 (1) Y81KFT (2) PAT81KFT (3) Y4PC834 (3) PAT4PC834 (3)	1-5/8"					
YA44LTC12FX45	2					3.06 [78]	3.74 [95]																			
YA44LTC12FX90	3					3.28 [84]	2.06 [53]																			
YA44LTC58FX	1					-----	4.04 [103]	.66 [17]	.67 [17]	L115	YELLOW	U44XRT UR4141WE (2)	U44XRT UR4141WE (2)	U44XRT UR4141WE (2)												
YA44LTC58FX45	2					3.06 [78]	.69 [18]								3.99 [101]											
YA44LTC58FX90	3					2.19 [56]	3.28 [84]								2.31 [59]											
YA44LNT12FX	1					-----	-----		1/2 [M12]	1.65 [42]	1.62 [41]	-----	.56 [14]	3.98 [101]	.62 [16]	1.50 [38]	.33 [8]	.64 [16]	L115			YELLOW	U44XRT UR4141WE (2)	U44XRT UR4141WE (2)	U44XRT UR4141WE (2)	
YA44LTC38FX	1									3/8 [M10]	2.19 [56]	-----	.41 [10]	3.73 [95]	.50 [13]	.51 [13]										

B

B

A

A

SEE SHEET 1 OF 18 FOR NOTES

TO ORDER BURNDY® PRODUCTS CALL		HYLUG™	
UNITED STATES 1-800-346-4175 (LONDONDERRY, NH)		ITEM NO: N/A	CAT. NO: YA44L-TC-FX-
CANADA: 1-800-361-6975 (QUEBEC) 1-800-387-6487 (ALL OTHER PROVINCES)		DRAWN BY: D FILLION 12/17/92	CHECKER: K HENRY 12/18/92
FOR PRODUCT INFO: <a href="http://www.burndy.com">http://www.burndy.com</a>		DSN APPVL: C PALAGI 12/22/92	MFG APPVL: --
		GA APPVL: A LLOYD 12/31/92	MKT APPVL: T NELSON 01/12/93
		PROD FAM: CM&R Compression	DRAWING NO: SE208001
		PROJECT #: --	SCALE: 1:1
		DOCUMENT TYPE: Sales	SHEET 18 OF 18
		REL LEVEL: Released	REV: M



REV: PEO200