

User Manual Utilities ISU-01

S-700 Standalone Rack Access Control SmartCard + Passcode



Designed and manufactured by Austin Hughes

FC CE  REACH

Legal Information

First English printing, January 2018

Information in this document has been carefully checked for accuracy; however, no guarantee is given to the correctness of the contents. The information in this document is subject to change without notice. We are not liable for any injury or loss that results from the use of this equipment.

Safety Instructions

Please read all of these instructions carefully before you use the device. Save this manual for future reference.

- Unplug equipment before cleaning. Don't use liquid or spray detergent; use a moist cloth.
- Keep equipment away from excessive humidity and heat. Preferably, keep it in an air-conditioned environment with temperatures not exceeding 40° Celsius (104° Fahrenheit).
- When installing, place the equipment on a sturdy, level surface to prevent it from accidentally falling and causing damage to other equipment or injury to persons nearby.
- When the equipment is in an open position, do not cover, block or in any way obstruct the gap between it and the power supply. Proper air convection is necessary to keep it from overheating.
- Arrange the equipment's power cord in such a way that others won't trip or fall over it.
- If you are using a power cord that didn't ship with the equipment, ensure that it is rated for the voltage and current labeled on the equipment's electrical ratings label. The voltage rating on the cord should be higher than the one listed on the equipment's ratings label.
- Observe all precautions and warnings attached to the equipment.
- If you don't intend on using the equipment for a long time, disconnect it from the power outlet to prevent being damaged by transient over-voltage.
- Keep all liquids away from the equipment to minimize the risk of accidental spillage. Liquid spilled on to the power supply or on other hardware may cause damage, fire or electrical shock.
- Only qualified service personnel should open the chassis. Opening it yourself could damage the equipment and invalidate its warranty.
- If any part of the equipment becomes damaged or stops functioning, have it checked by qualified service personnel.

What the warranty does not cover

- Any product, on which the serial number has been defaced, modified or removed.
- Damage, deterioration or malfunction resulting from:
 - Accident, misuse, neglect, fire, water, lightning, or other acts of nature, unauthorized product modification, or failure to follow instructions supplied with the product.
 - Repair or attempted repair by anyone not authorized by us.
 - Any damage of the product due to shipment.
 - Removal or installation of the product.
 - Causes external to the product, such as electric power fluctuation or failure.
 - Use of supplies or parts not meeting our specifications.
 - Normal wear and tear.
 - Any other causes which does not relate to a product defect.
- Removal, installation, and set-up service charges.

Regulatory Notices Federal Communications Commission (FCC)

This equipment has been tested and found to comply with the limits for a Class B digital device, pursuant to Part 15 of the FCC rules. These limits are designed to provide reasonable protection against harmful interference in a residential installation.

Any changes or modifications made to this equipment may void the user's authority to operate this equipment. This equipment generates, uses, and can radiate radio frequency energy and, if not installed and used in accordance with the instructions, may cause harmful interference to radio communications.

However, there is no guarantee that interference will not occur in a particular installation. If this equipment does cause harmful interference to radio or television reception, which can be determined by turning the equipment off and on, the user is encouraged to try to correct the interference by one or more of the following measures:

- Re-position or relocate the receiving antenna.
- Increase the separation between the equipment and receiver.
- Connect the equipment into an outlet on a circuit different from that to which the receiver is connected.

Notice : The changes or modifications not expressly approved by the party responsible for compliance could void the user's authority to operate the equipment.

IMPORTANT NOTE: To comply with the FCC RF exposure compliance requirements, no change to the antenna or the device is permitted. Any change to the antenna or the device could result in the device exceeding the RF exposure requirements and void user's authority to operate the device.

Content

Part I. Required Cables	P.1
Part II. Package Contents	P.2
Part III. Key Hardware	
< 3.1 > Handle	P.3
< 3.2 > Control Panel	P.5
< 3.3 > Connector Box	P.6
< 3.4 > Junction Box	P.7
Part IV. Installation	
< 4.1 > Installation Diagram	P.8
< 4.2 > Handle	P.10
< 4.3 > Control Panel & Connector Box	P.16
< 4.4 > Junction Box	P.18
< 4.5 > Door Sensor	P.20
Part V. Initial Setup by Control Panel	
< 5.1 > Admin Passcode Assignment	P.25
< 5.2 > Control Panel Firmware	P.26
< 5.3 > User Passcode Assignment	P.28
< 5.4 > User Card Addition	P.29
< 5.5 > Screen	P.30
< 5.5 > Calibration	P.31

Content

Part VI. Utilities ISU-01

< 6.1 >	Software Features & Hardware Requirements	P.32
< 6.2 >	Supported OS Platform & Language	P.33
< 6.3 >	Utilities ISU-01 Download & Installation	P.34
< 6.4 >	Driver Installation for Data Input Cable	P.35
< 6.5 >	Initial Control Panel Configuration	P.39
< 6.6 >	User Card Assignment	P.42
< 6.7 >	Export & Import of Control Panel Configuration	P.43

Part VII. Control Panel & Handle Operation

< 7.1 >	Two Important Notes	P.46
< 7.2 >	Control Panel & Handle Operation	P.48

Part VIII. FAQ & Troubleshooting P.50

Part IX. Accessories P.52

Part I. Required Cables

 Below cable not provided

① Cat5 Cable

- For connection between Junction Box & Handle / Control Panel
- The cable length can be customized subject to rack size
- NOT provided



Part II. Package Contents

Unpacking

The equipment comes with the standard parts shown on the package contents. Check and make sure they are included and in good condition. If anything is missing, or damage, contact the supplier immediately.

	S-701P	S-702P	S-701M	S-702M
① Handle, pair	Proximity	Proximity	MiFARE	MiFARE
② SmartCard, 1pc				
③ Control panel	1	2	1	2
④ Connector box	1	2	1	2
⑤ Connector box to handle cable	1	2	1	2
⑥ Control panel screw set	1	2	1	2
⑦ Junction box	1	1	1	1
⑧ Key	1	1	1	1
⑨ Power cord, 6ft	1	1	1	1
⑩ Handle screw set	1	1	1	1
⑪ Cable clip	8	8	8	8



- ⑥ Control panel screw set :
- Mounting kit. pair
 - M3 x 10mm screw, 4pcs



- ⑨ 6ft Power cord x 1

- ⑩ Handle screw set
- refer to user manual < 4.2 >

- ⑪ Cable clip x 8

Part III. Key Hardware

< 3.1 > Handle

Unit : mm

Cut-out
(Universal Mounting)

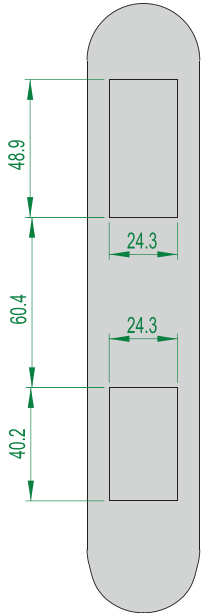

Front View

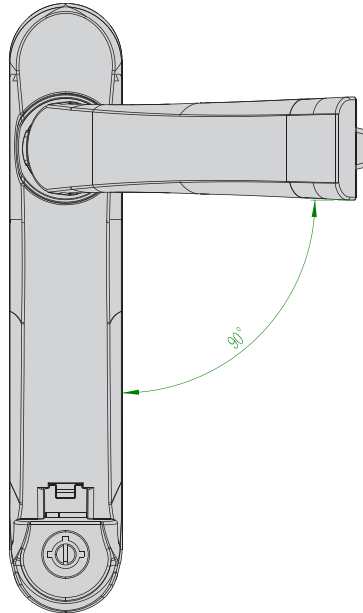

Side View Open

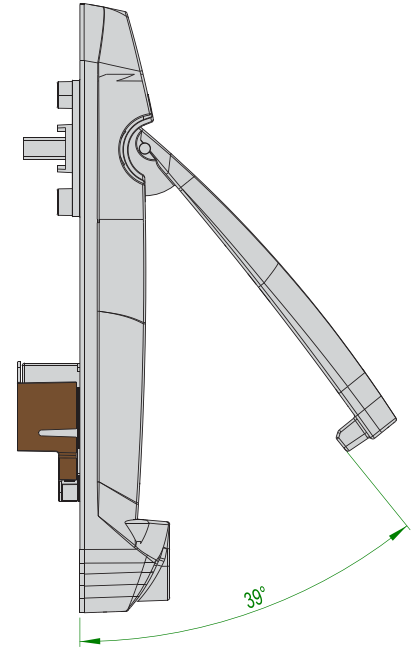

Back View

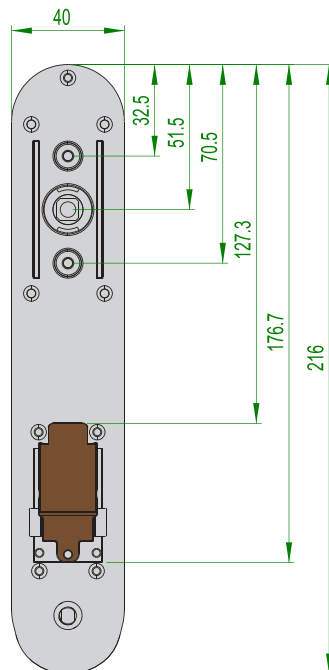

Side View Close

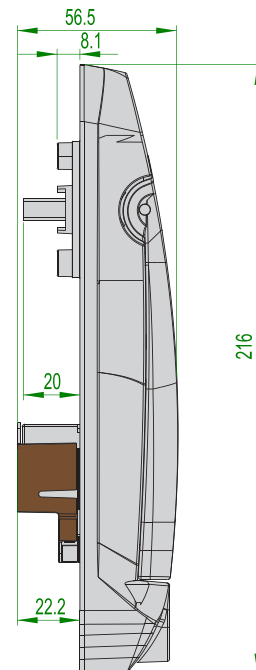

< 3.1 > Handle

①	Connect door sensor cable (Mechanical / IR)
②	To Connector Box via bundled Cat5 cable (400mm)
③	Connect Temp. / TH sensor



< 3.2 > Control Panel

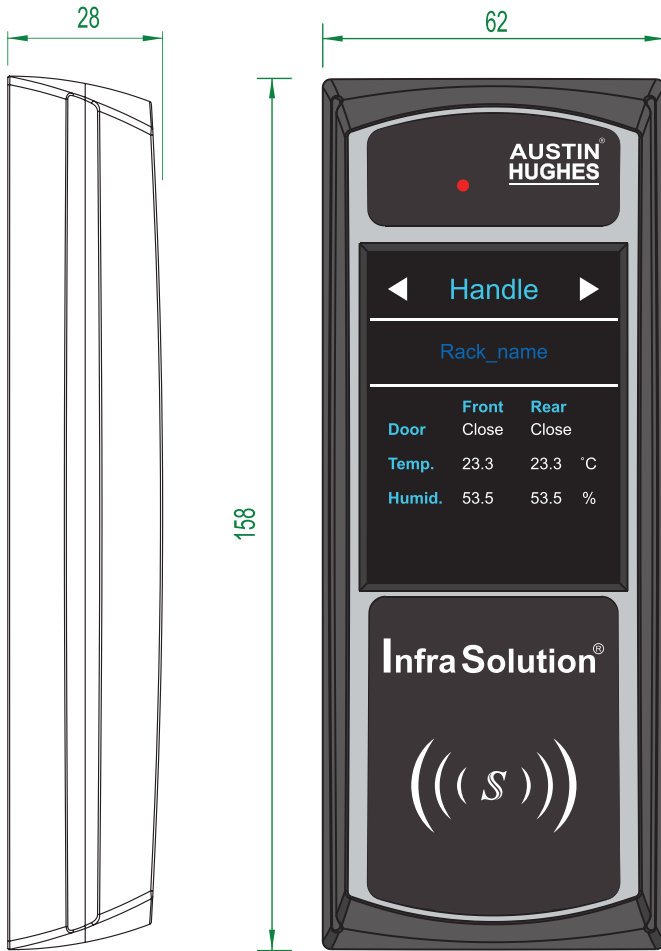

Reset Button

To re-power the panel if necessary but won't cause any change on setting and memories

2.8" color LCD w/ Touchscreen

Sensor area

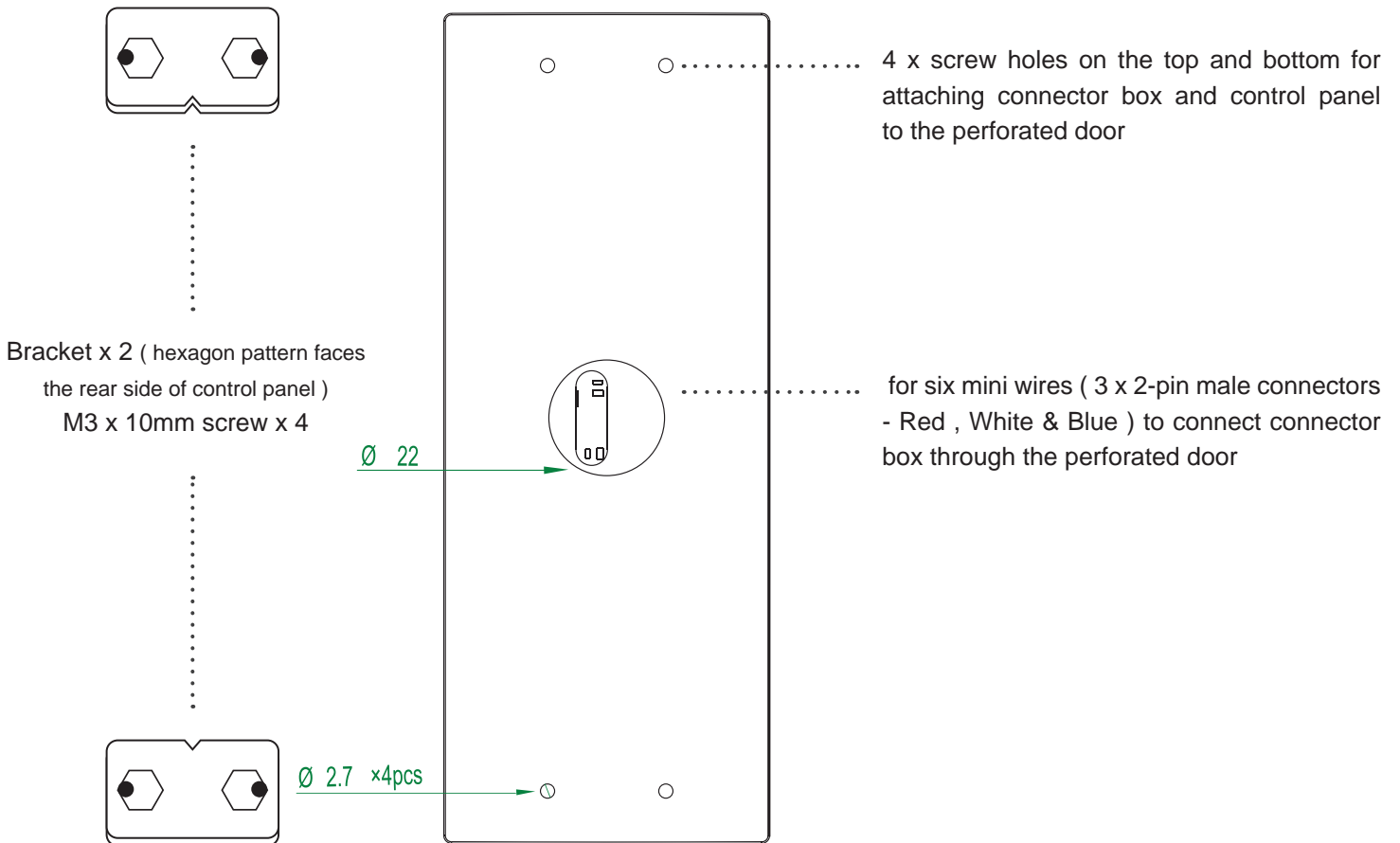

< 3.3 > Connector Box

Unit : mm

Top View

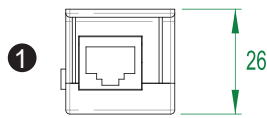

①	2 x RJ-45 connector to handle (top & bottom)
②	3 x 2-pin mini female connectors (Red, White & Blue)
③	1 x RJ-45 connector to Junction box
④	Data input connector Phone jack for data input cable (ISW-USB-1.8)
⑤	2 x screw hole for fixing to control panel (top & bottom)

Right Side View

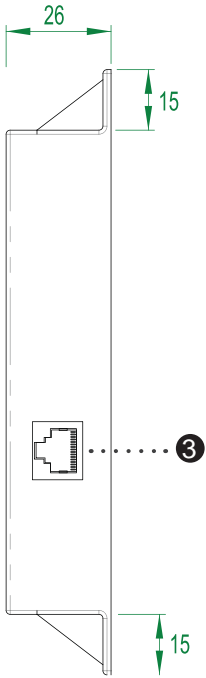

Bottom View

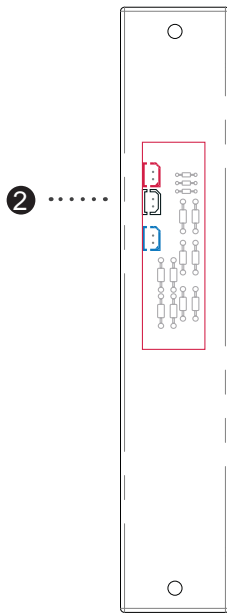

Left Side View

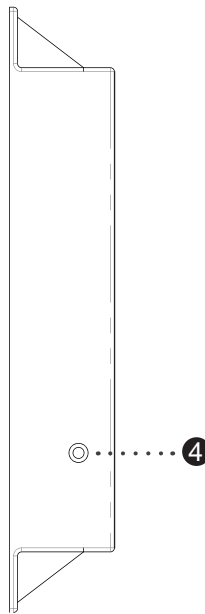

Front View

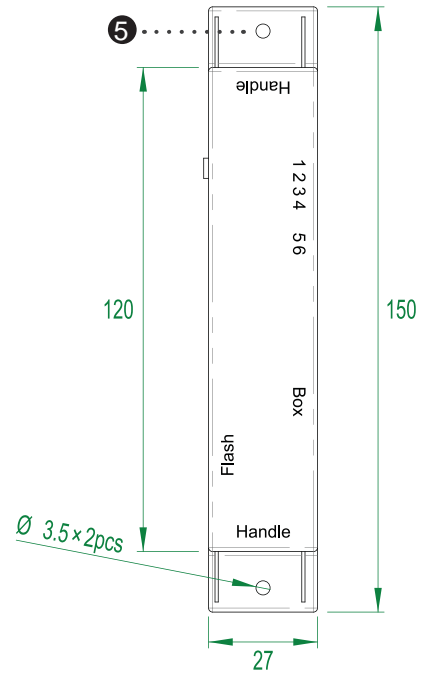

Correct installation position for **right side open**

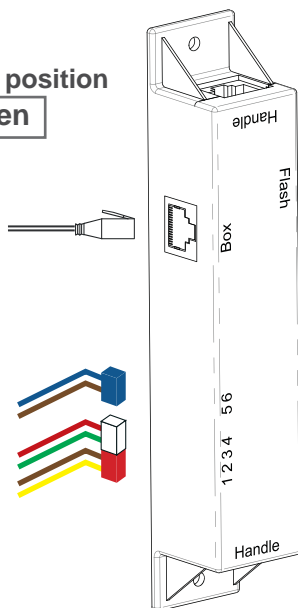

Correct installation position for **left side open**

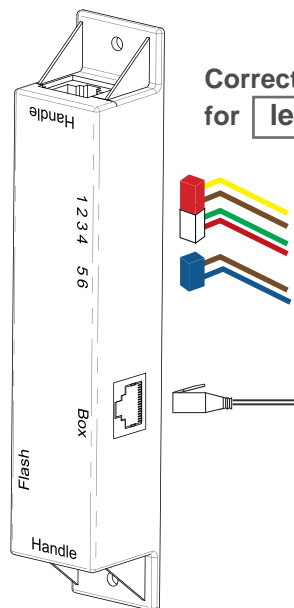

 Incorrect installation may cause installation difficulties

< 3.4 > Junction Box

Junction box dimension :

Unit : mm

Top View

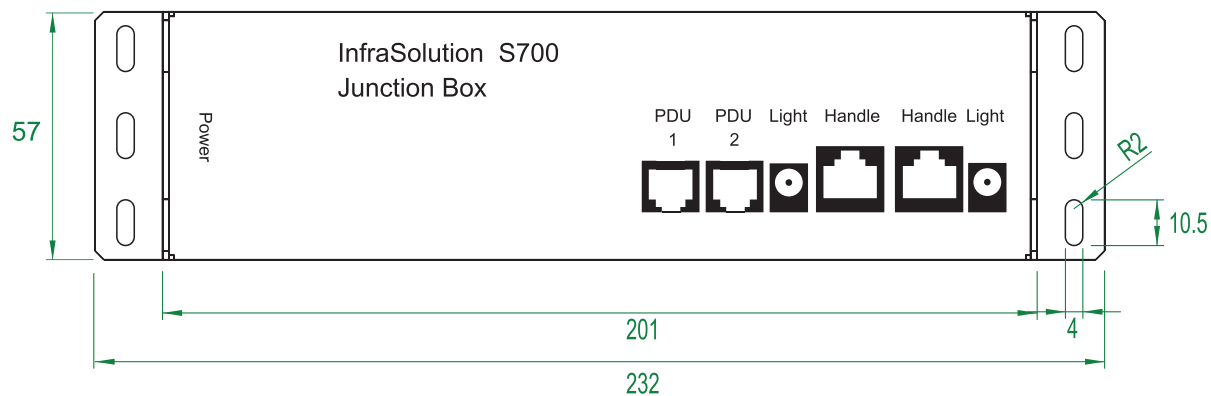

Front View

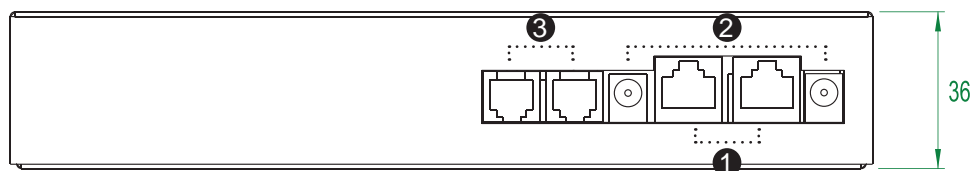

①	2 x RJ-45 connectors to handle / connector box
②	2 x IR LED light bar connectors
③	2 x RJ-11 connectors to TH2 port of W3 PDU meter

Part IV. Installation

< 4.1 > Installation Diagram

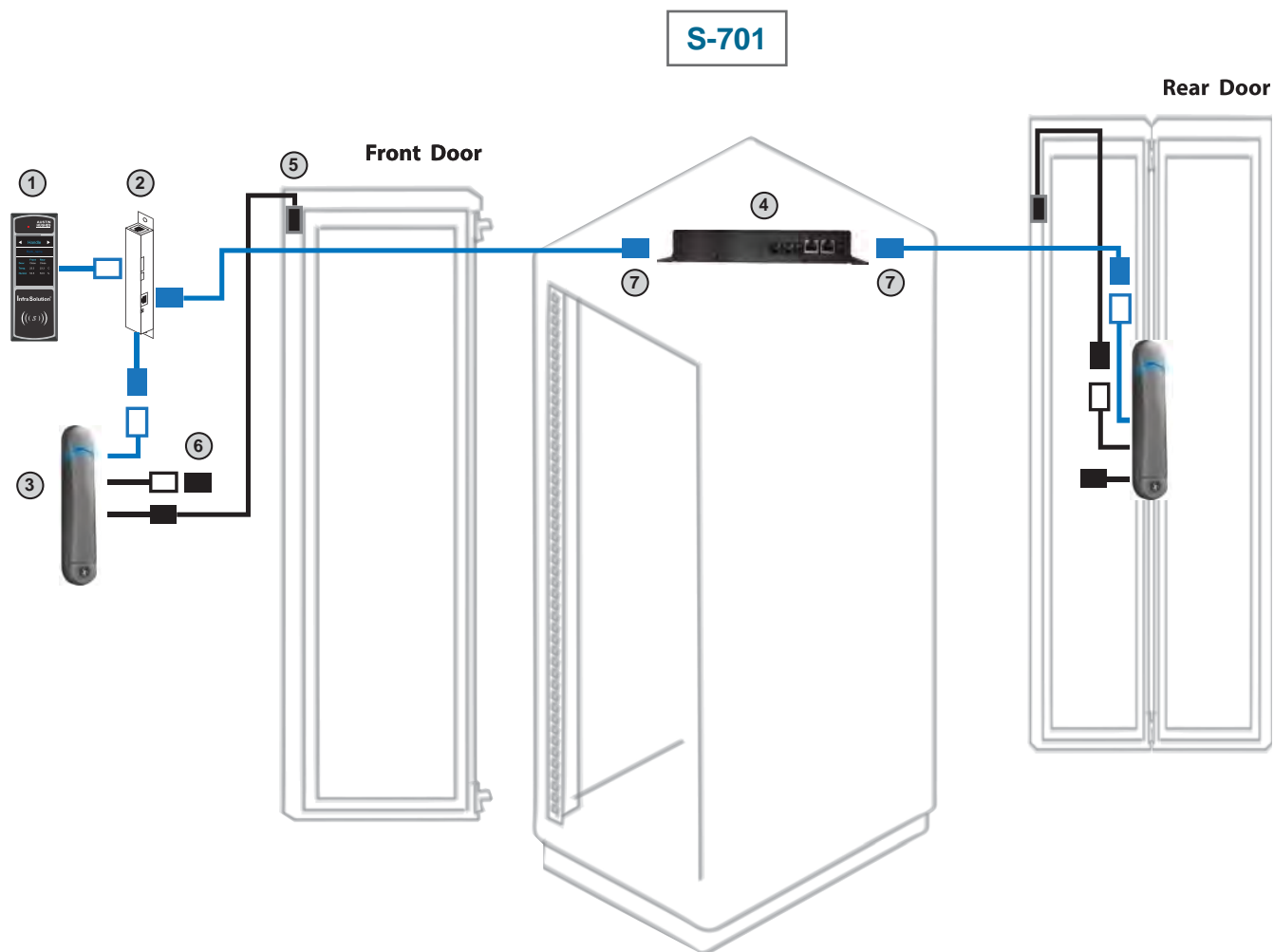

- ① Control Panel * Please refer to Package Contents on P.2
- ② Connector Box
 - for data input / configuration
- ③ S-700 SmartCard handle
 - Proximity or MiFARE
- ④ Junction Box
 - data communication for control panels & handles
 - provides connectors for light bar & W3 PDU integration
 - built-in power adapter
- ⑤ Door sensor with 2m cable
 - for front & rear doors
- ⑥ Temp. / TH sensor connector
- ⑦ Cat5 cable
 - for connection between junction box & handle / control panel
 - The cable length can be customized subject to rack size
 - NOT provided

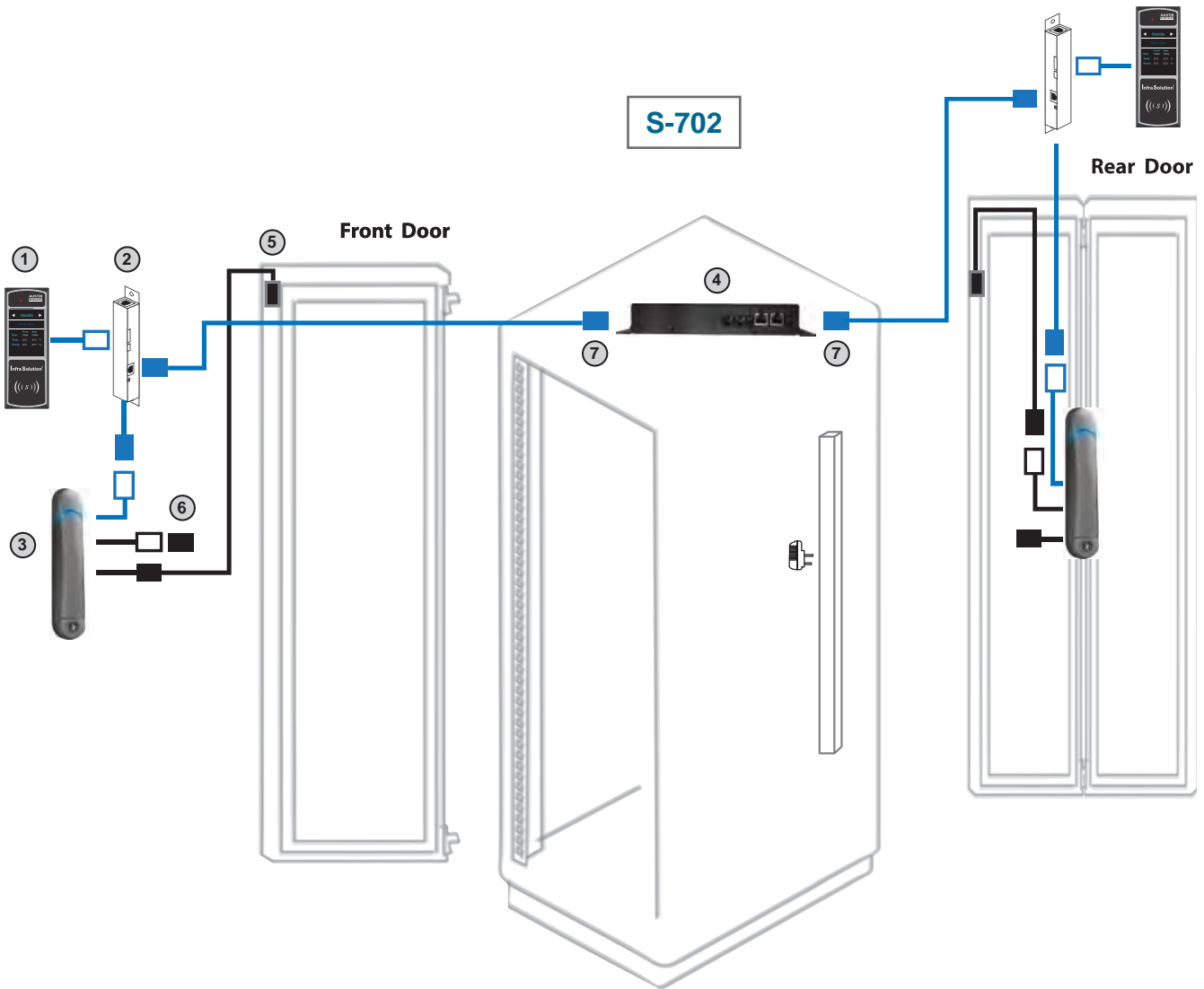

- ① Control Panel * Please refer to Package Contents on P.2
- ② Connector Box
 - for data input / configuration
- ③ S-700 SmartCard handle
 - Proximity or MiFARE
- ④ Junction Box
 - data communication for control panels & handles
 - provides connectors for light bar & W3 PDU integration
 - built-in power adapter
- ⑤ Door sensor with 2m cable
 - for front & rear doors
- ⑥ Temp. / TH sensor connector
- ⑦ Cat5 cable
 - for connection between junction box & handle / control panel
 - The cable length can be customized subject to rack size
 - NOT provided

< 4.2 > Handle

Single Point Lock

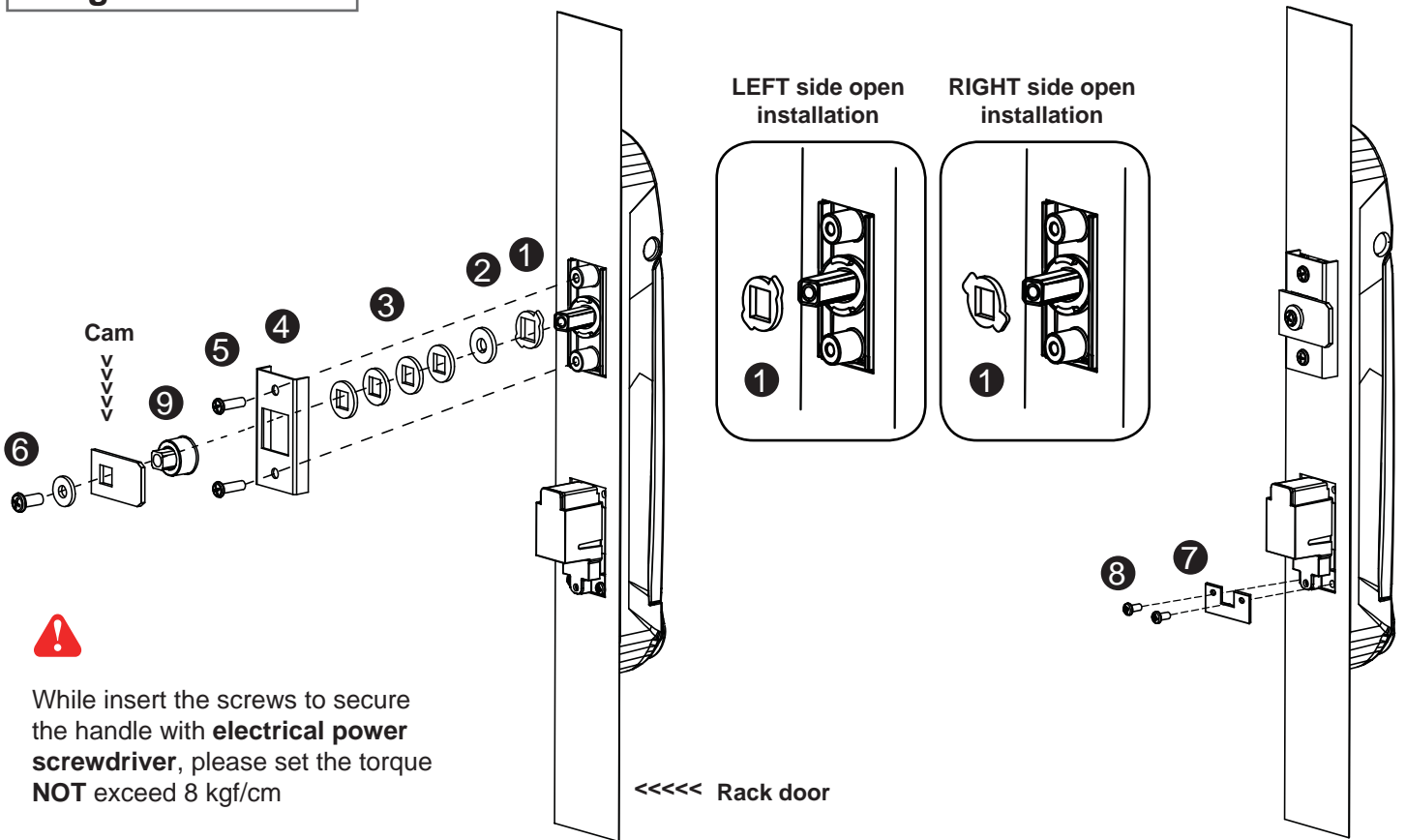

1. Insert **1** metal washer, **2** plastic washer and **3** metal square hole washer x 4 to the spigot of the smartcard handle.
2. Mount the smartcard handle to the universal mounting position.
3. Place the **4** handle mounting bracket with **5** M4 x 9mm screw x 2 to secure the handle.
4. Attach the **Cam** with **3** metal square washer(s) to adjust and to fit the cam locking position.
The extension spigot **9** required or not for installation is subject to the rack door locking design.
Note : - If the cam cannot fit the locking position after adjustment, customization for the cam is required.
- Cam customization service upon your request, please contact your sales representative.
5. Insert the **6** M6 x 15mm screw x 1 with circle hole washer to secure the **Cam** to the handle.
6. Place the **7** U bracket with **8** M3 x 10mm screw x 2 to further secure the handle in place.

Handle mounting screw set for single point lock

		Qty.	Single Point Lock
1	Metal washer (related to Left or Right side open)	2	✓
2	Plastic washer	2	✓
3	Metal square hole washer	8	✓
4	Handle mounting bracket	2	✓
5	M4 x 9mm screw for 4	4	✓
6	Circle hole washer w/ M6 x 15mm screw	2	✓
7	U bracket	2	✓
8	M3 x 10mm screw for 7	4	✓
9	Extensions spigot	2	✓

< 4.2 > Handle

 Pay attention to the below. Otherwise, it may cause operation problem.

1. Make sure
 - ① Cam lock can slide into the hole without stress.
 - ② The cut-out of the cam hole with enough space tolerance.



Cam lock hole
 enough
tolerance

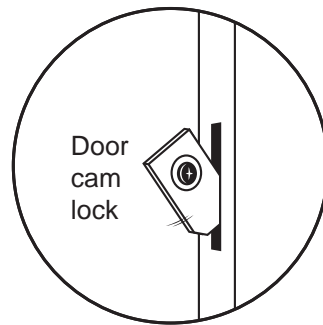

Cam lock hole
 limited
tolerance

 Cam lock customization may be required to retrofit your rack.

2. Make sure the rack doors are rigid and no bending.

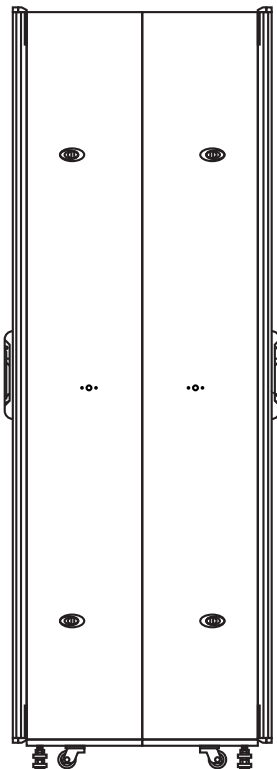

 Rigid
door

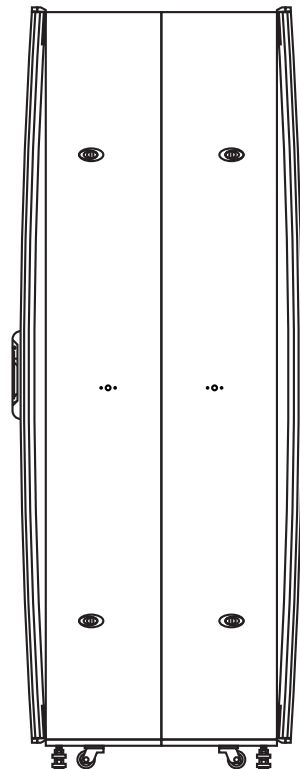

 Bending
door

< 4.2 > Handle

2-point Lock (light-duty rod-latch)

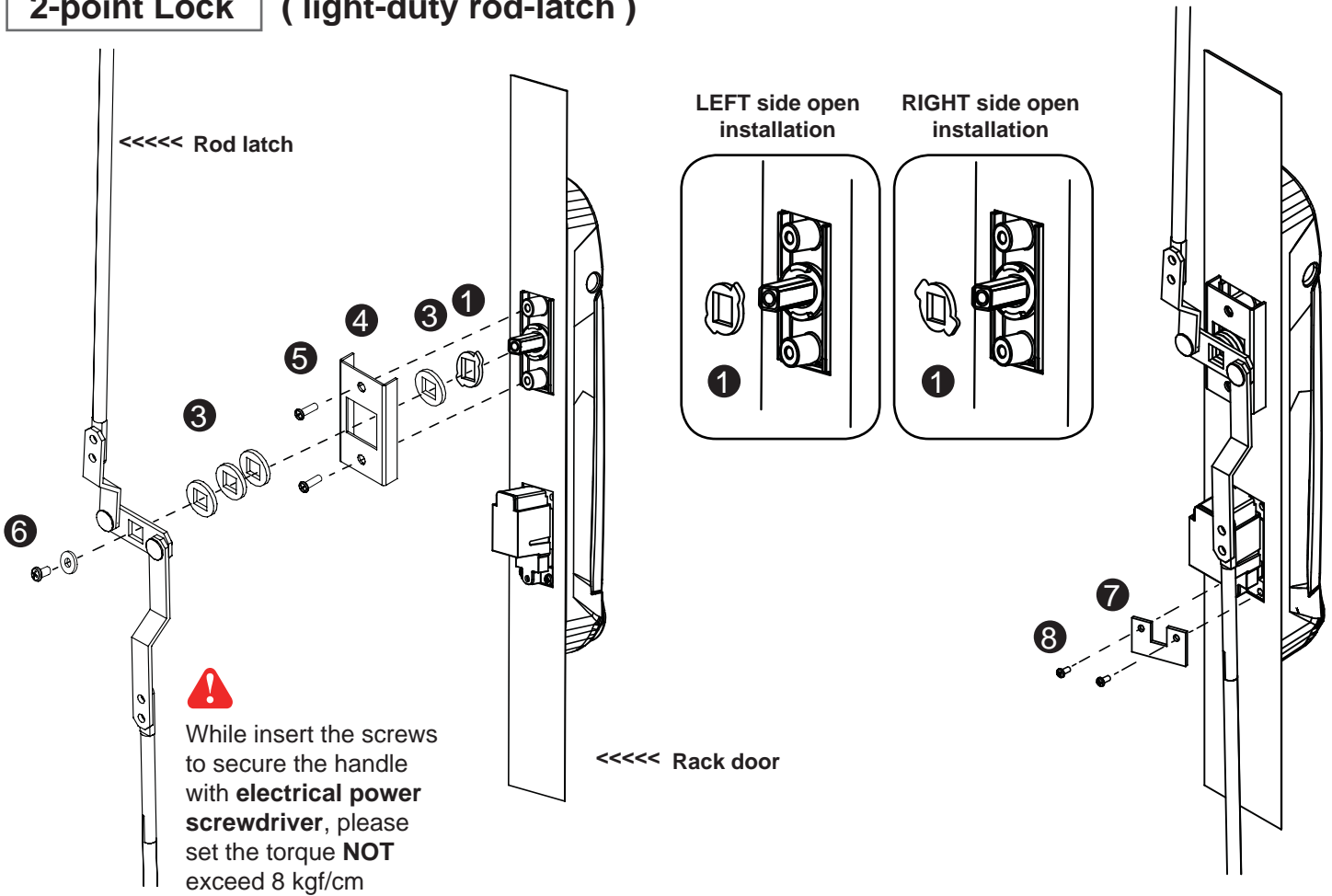

1. Insert **①** metal washer and **③** metal square hole washer to the spigot of the smartcard handle.
2. Mount the smartcard handle to the universal mounting position.
3. Place the **④** handle mounting bracket with **⑤** M4 x 9mm screw x 2 to secure the handle.
4. Attach the **Rod-latch** with **③** metal square hole washer(s) to adjust and to fit the door top & bottom locking position.
5. Insert the **⑥** M6 x 15mm screw x 1 with circle hole washer to secure the **Rod-latch** to the handle.
6. Place the **⑦** U bracket with **⑧** M3 x 10mm screw x 2 to further secure the handle in place.

Handle mounting screw set for 2-point lock (light-duty)

		Qty.	2-Point Lock light-duty
①	Metal washer (related to Left or Right side open)	2	✓
②	Plastic washer	2	X
③	Metal square hole washer	8	✓
④	Handle mounting bracket	2	✓
⑤	M4 x 9mm screw for ④	4	✓
⑥	Circle hole washer w/ M6 x 15mm screw	2	✓
⑦	U bracket	2	✓
⑧	M3 x 10mm screw for ⑦	4	✓
⑨	Extensions spigot	2	X

< 4.2 > Handle

 Pay attention to the below. Otherwise, it may cause operation problem.

1. Make sure
 - ① Two ends of latch rod can entry into the top & bottom holes without stress.
 - ② The top & bottom holes with enough space tolerance.

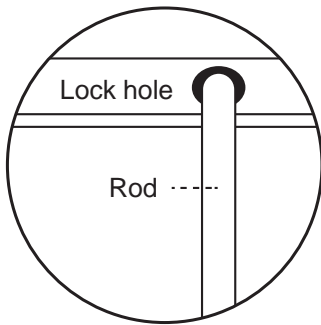

2-point lock holes
(top & bottom)

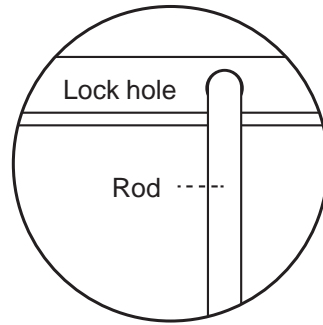

2-point lock holes
(top & bottom)

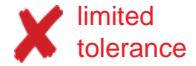

2. Make sure the rack doors are rigid and no bending.

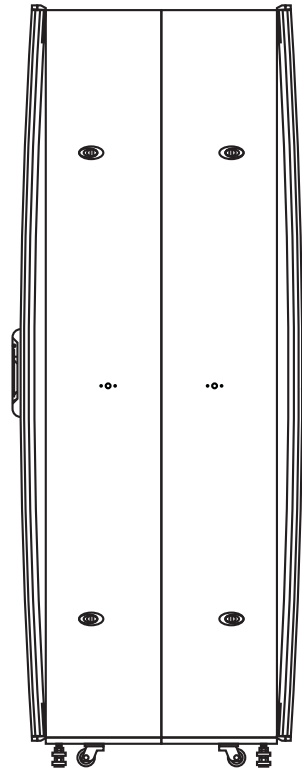
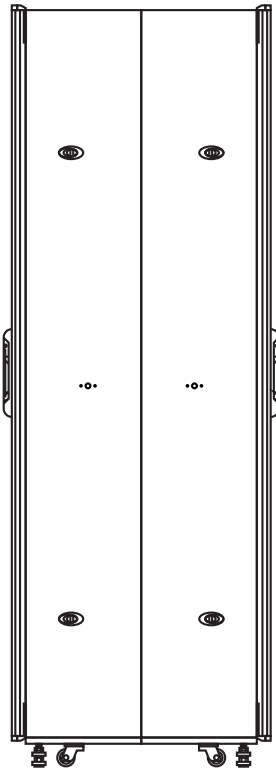

< 4.2 > Handle

2-point Lock (rod control system)

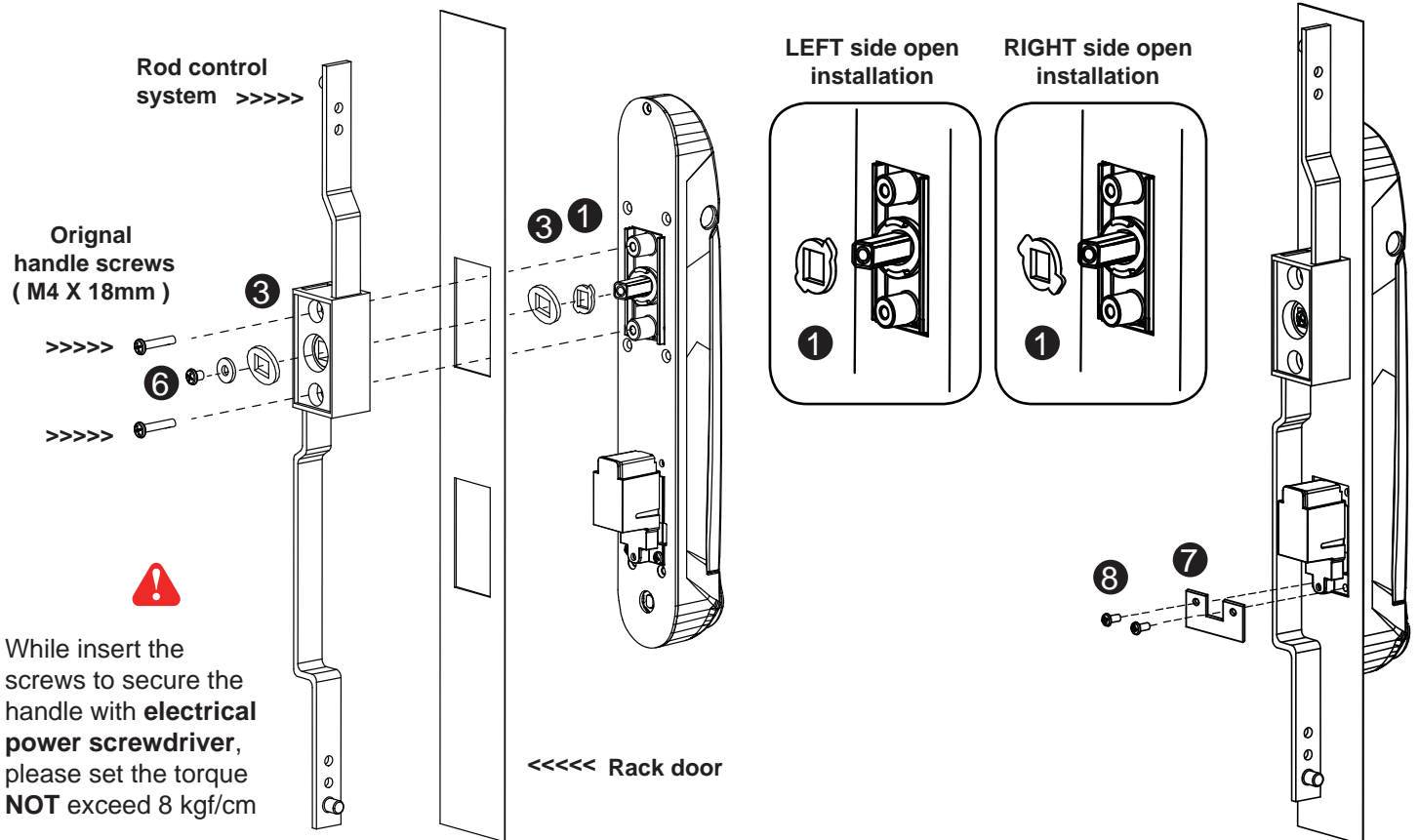

1. Insert **①** metal washer and **③** metal square hole washer to the spigot of the smartcard handle.
2. Mount the smartcard handle to the universal mounting position.
3. Attach the **Rod control system** to the handle, insert the **③** metal square hole washer x 1 and **⑥** M6 x 15mm screw x 1 with circle hole washer to secure the position.
4. Insert **Original handle screws** x 2 through the **Rod control system** and door to the handle to fix it in place.
5. Place the **⑦** U bracket with **⑧** M3 x 10mm screw x 2 to further secure the handle in place.

Handle mounting screw set for 2-Point Lock (with rod control)

		Qty.	2-Point Lock (with rod control)
①	Metal washer (related to Left or Right side open)	2	✓
②	Plastic washer	2	X
③	Metal square hole washer	4	✓
④	Handle mounting bracket	2	X
⑤	M4 x 9mm screw for ④	4	X
⑥	Circle hole washer w/ M6 x 15mm screw	2	✓
⑦	U bracket	2	✓
⑧	M3 x 10mm screw for ⑦	4	✓
⑨	Extensions spigot	2	X

< 4.2 > Handle

 Pay attention to the below. Otherwise, it may cause operation problem.

1. Make sure
 - ① Two ends of latch rod can entry into the top & bottom holes without stress.
 - ② The top & bottom holes with enough space tolerance.

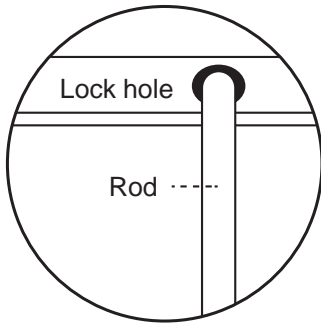

2-point lock holes
(top & bottom)
 enough
tolerance

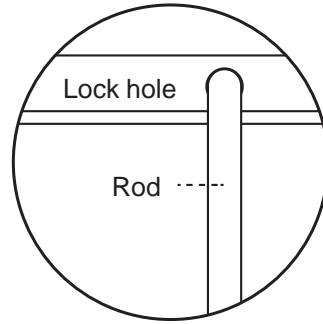

2-point lock holes
(top & bottom)
 limited
tolerance

2. Make sure the rack doors are rigid and no bending.

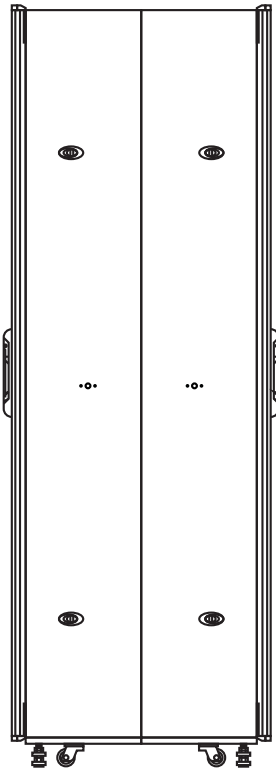

 Rigid
door

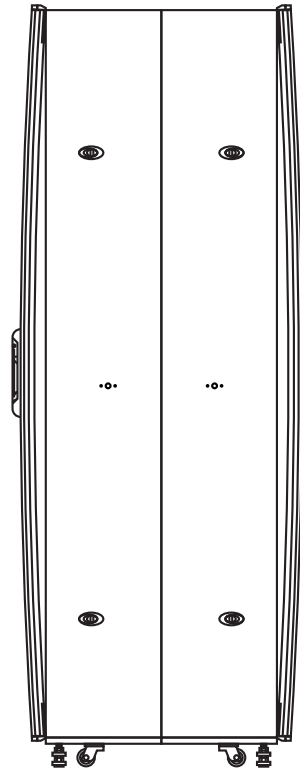

 Bending
door

< 4.3 > Control Panel & Connector Box

Left Side Open

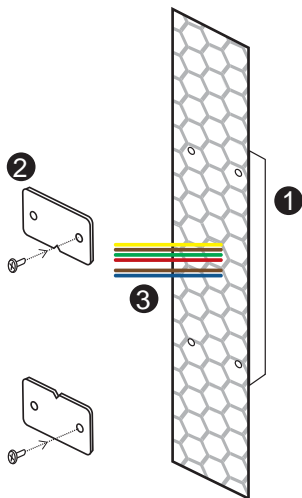

Step < 1 >

- Mount the ① Control Panel on the perforated door with the ② bracket sets.

Note : The hexagon pattern on the perforated door must be as below :

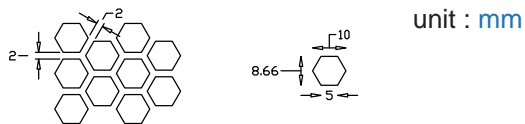

Step < 2 >

- Meanwhile, pass the ③ six mini color wires through the perforated hole to the rear side.

Note : Control panel always on the top of handle and the distance should not over 200mm.

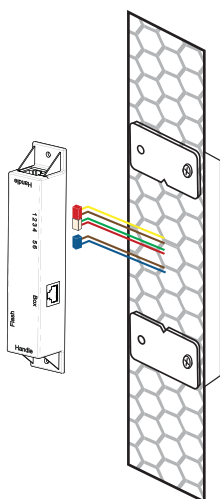

Step < 3 >

- Connect the 3 x 2-pin male connectors to the 3 x 2-pin female connectors on the connector box.

⚠ Please make sure the color of connectors matches at both sides. Otherwise, it will cause device failure

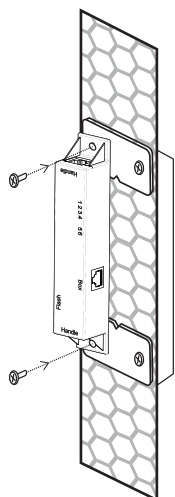
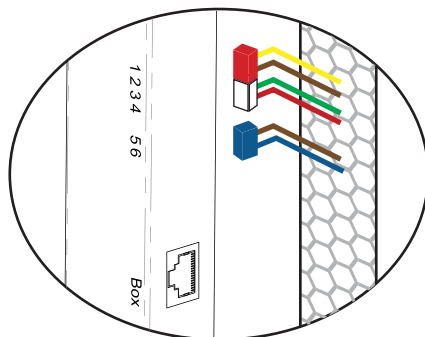

Step < 4 >

- Fix the Connector Box on the top and bottom with M3 x 10mm screw x 2.

< 4.3 > Control Panel & Connector Box

Right Side Open

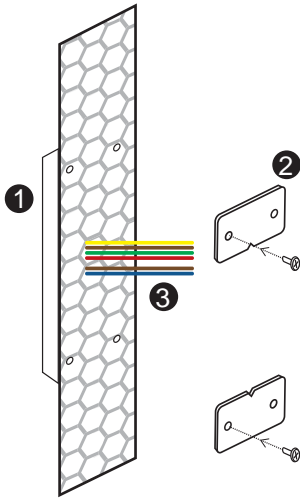

Step < 1 >

- Mount the ① Control Panel on the perforated door with the ② bracket sets.

Note : The hexagon pattern on the perforated door must be as below :

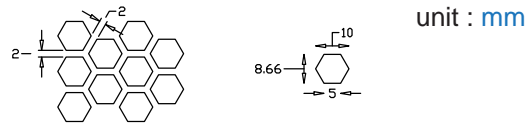

Step < 2 >

- Meanwhile, pass the ③ six mini color wires through the perforated hole to the rear side.

Note : Control panel always on the top of handle and the distance should not over 200mm.

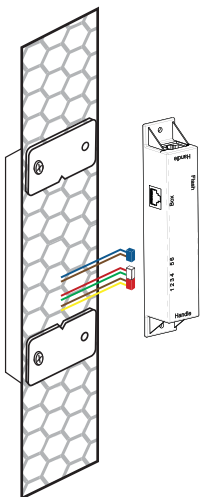

Step < 3 >

- Connect the 3 x 2-pin male connectors to the 3 x 2-pin female connectors on the connector box.

 Please make sure the color of connectors matches at both sides. Otherwise, it will cause device failure

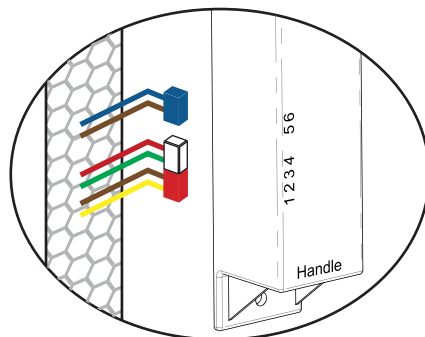

Step < 4 >

- Fix the Connector Box on the top and bottom with M3 x 10mm screw x 2.

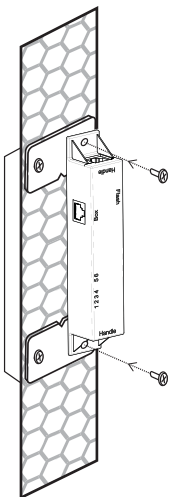

< 4.4 > Junction Box

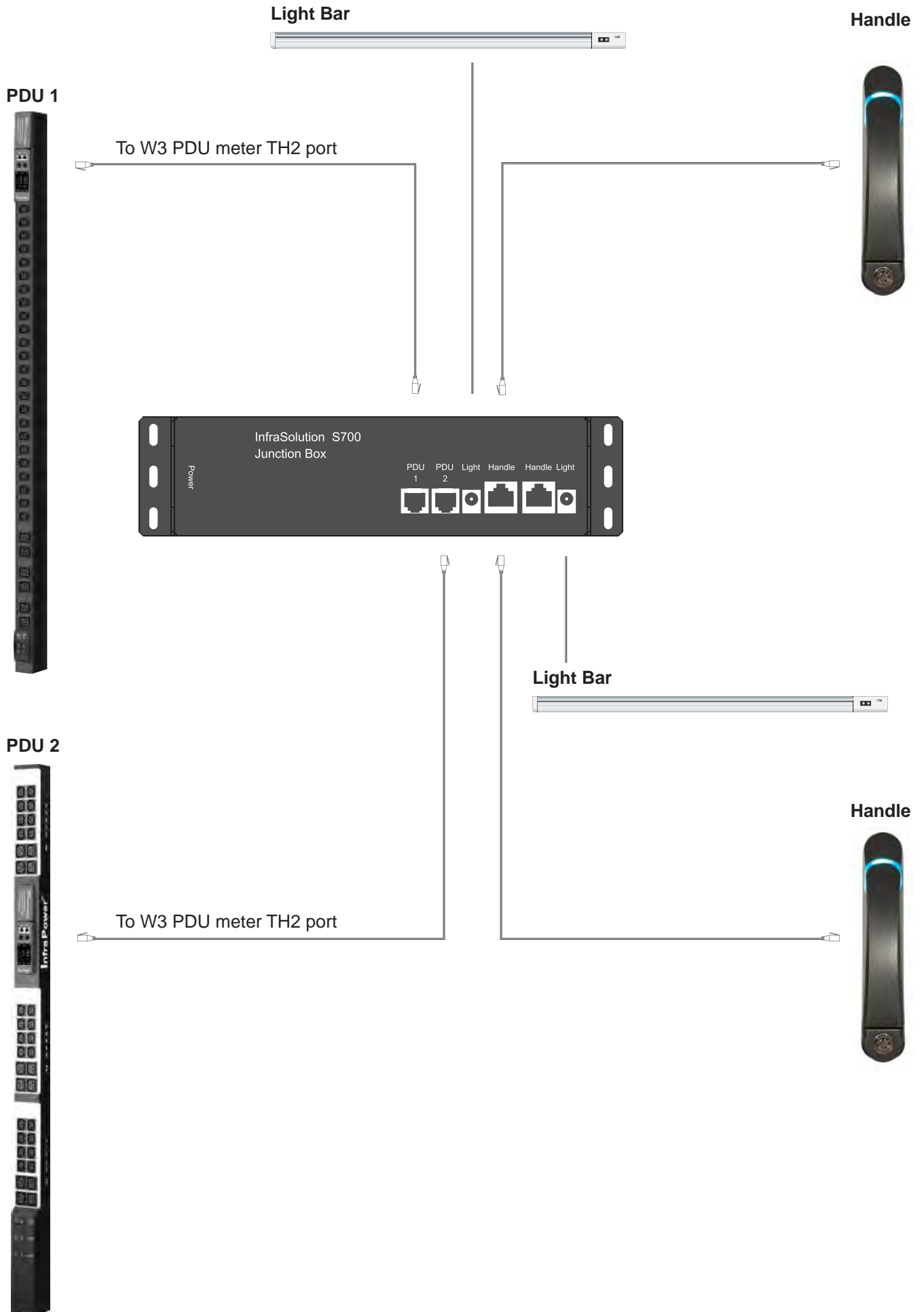

Intentionally Left Blank

< 4.5 > Door Sensor

Door sensor is an essential accessories as users can be alerted by visual and audio alarm for unauthorized access.

IR Door Sensor, pair (S-DIR)

- No custom cutting required on doors
- Light weight / adhesive
- Magnetic base for easy setup
- Mini size (33 x 19 x 7 mm)
- With 2m cord



unit : mm

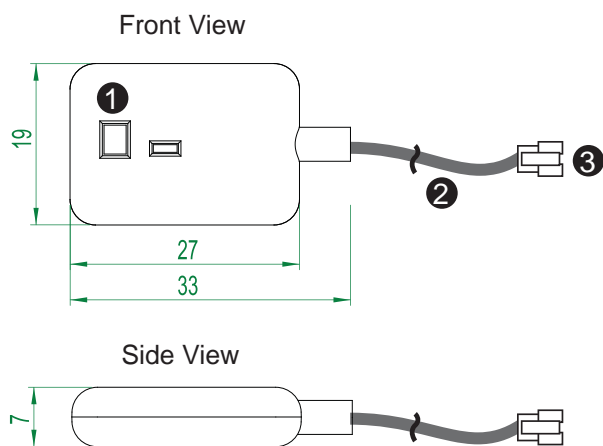

①	Sensor area
②	2m cable
③	Cable jack (connect to handle)

Package content

- IR sensor w/ 2m cable x 2
- 2mm adhesive tape x 6

Requirements

- rack frame made of ferrous metal (iron)
- sensing distance

Black surface : < 8mm (door close)	> 10mm (door open)
Surface with other colors : < 25mm (door close)	> 35mm (door open)

< 4.5 > Door Sensor

Installation steps

- connect to the handle
- guide & fix the cable with cable clips (bundle with handle package)
- place the sensor at the top of the door, close to the hinge side
- adjust the sensor to ensure the sensing distance between door to frame within 5mm while door in close status



sensing distance

Black surface : < 8mm (door close)
> 10mm (door open)

Surface with other colors : < 25mm (door close)
> 35mm (door open)

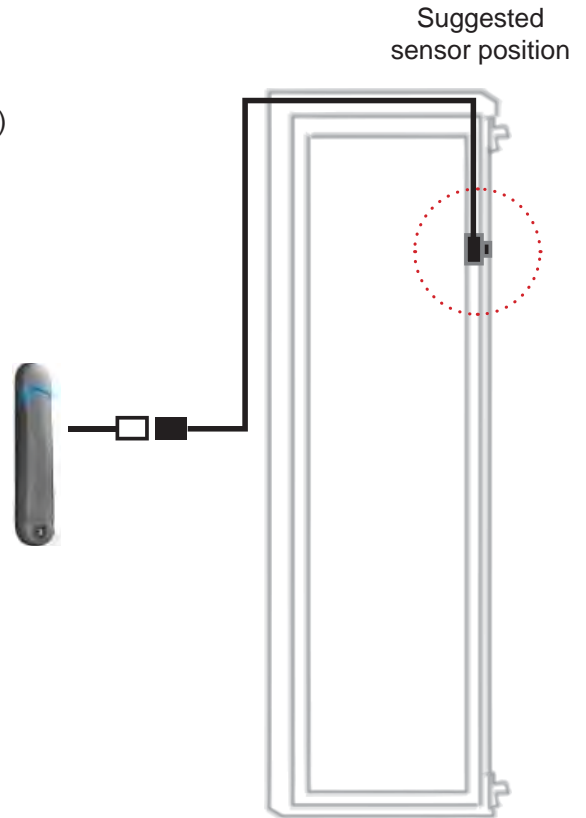

Sensor Operation

DOOR CLOSE

- close door
- IR sensor detects the rack frame
- DOOR CLOSE SIGNAL sends out

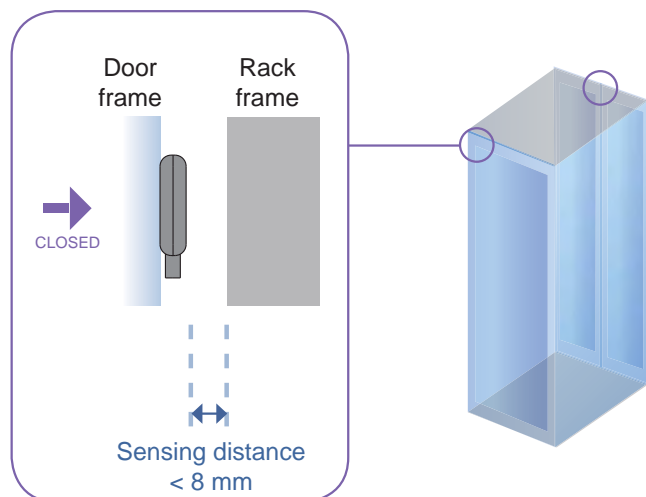

DOOR OPEN

- open door
- IR sensor lose detection with rack frame
- DOOR OPEN SIGNAL sends out

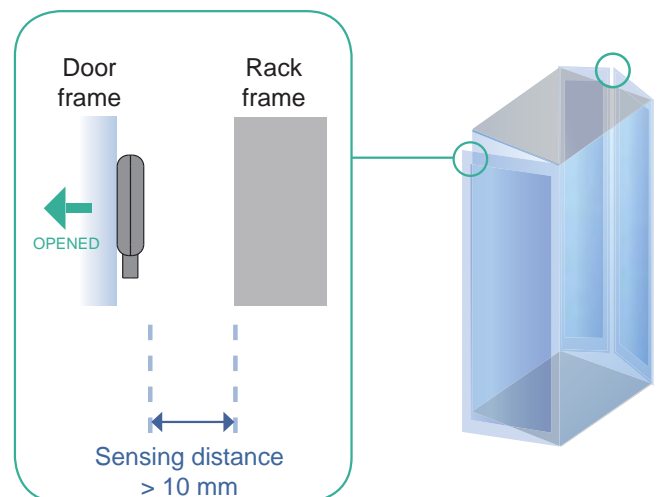

sensing distance

Black surface : < 8mm (door close)
Surface with other colors : < 25mm (door close)

> 10mm (door open)
> 35mm (door open)

< 4.5 > Door Sensor

Mechanical Door Sensor (S-DSW)

- Custom cutting required on doors
- Low cost / precise
- Cost efficient integration to new rack
- Size (52 x 22.5 x 30.75 mm)
- With 2m cord

unit : mm

Front View

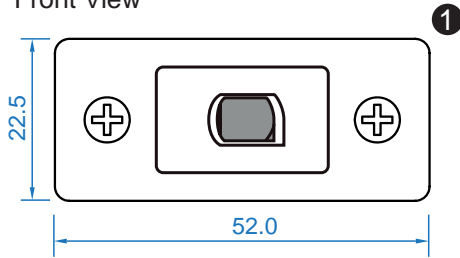

Top View

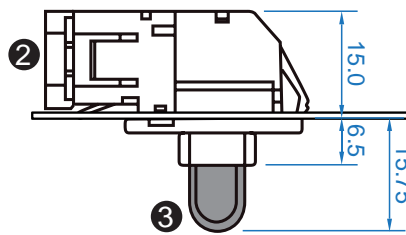

Side View

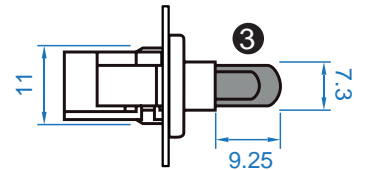

①	Steel mounting plate with 2 screw holes
②	Cable connector
③	Press button (total travel distance : 9.25 mm) (min. actuation distance : 3.00 mm)

Package content

- Mechanical sensor w/ 2m cable x 2
- Mounting screws 6#32x4.5mm x 2



Requirements

- custom hole cutting required on doors
- ordering a sample for custom cutting is highly suggested
- min. actuation distance : 3.00 mm
- total travel distance : 9.25 mm

unit : mm

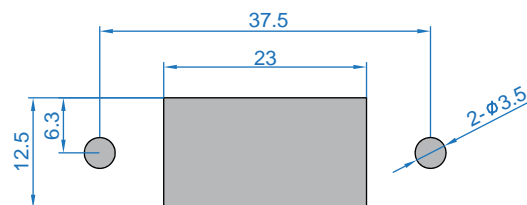

Dimension of door cutting hole

- circle hole x 2 for screw mounting
- rectangle hole x 1 for sensor installation

< 4.5 > Door Sensor

Installation steps

- connect to the handle
- place the sensor at the top middle of the door
- install the sensor in the custom hole
- secure it with bundled mounting screws 6#32x4.5mm x 2

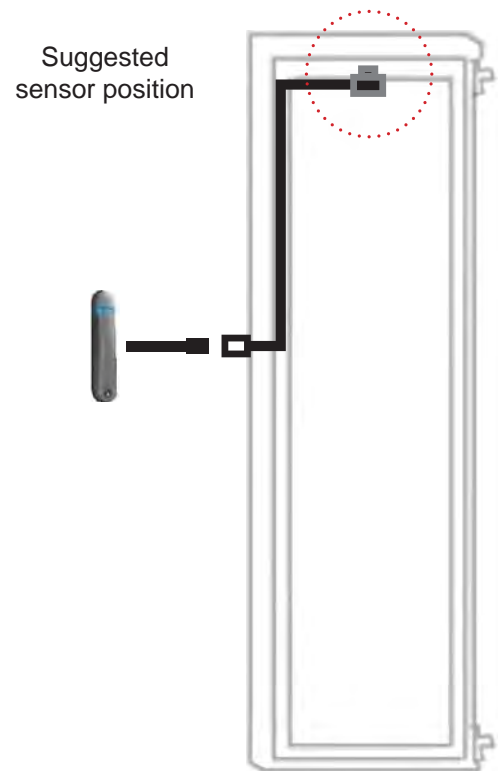

Sensor Operation

DOOR CLOSE

- close door
- Sensor button is pressed on
- DOOR CLOSE SIGNAL sends out

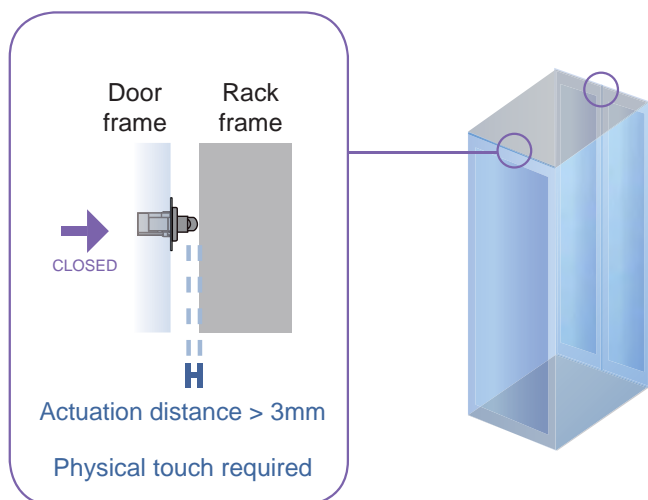

DOOR OPEN

- open door
- Sensor button is released
- DOOR OPEN SIGNAL sends out

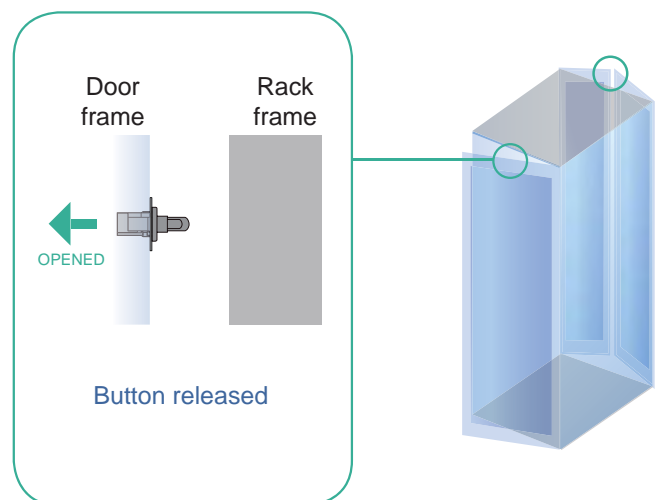

Intentionally Left Blank

Part V. Initial Setup by Control Panel

< 5.1 > Admin Passcode Assignment

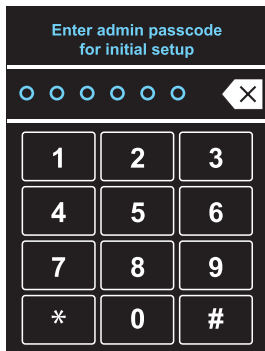

1. Input default admin passcode (default : 000000)

 In this stage, you can just use a physical key for door open.
No smartcard can be assigned until you complete the admin passcode assignment.

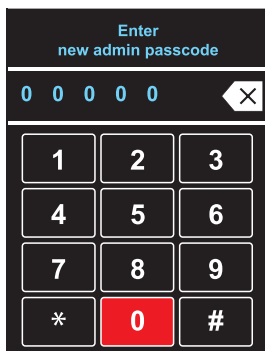

2. Input new admin passcode

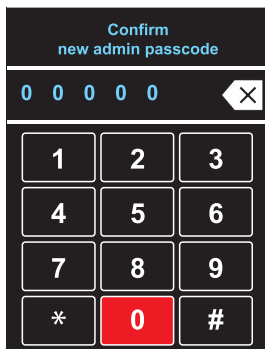

3. Input new admin passcode again to confirm

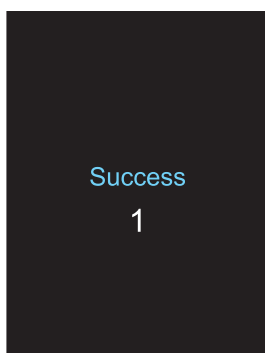

4. " Success " page show up 5 seconds

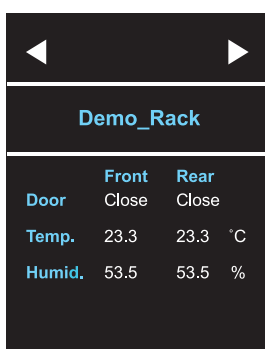

5. After 5 seconds, return to Main page

< 5.2 > Control Panel Firmware

S-700 handle series provide two models, S-701 with one control panel while S-702 with two control panels.

You must select the correct firmware for the control panel. Otherwise, it doesn't work.

Please follow 5 steps below to enter the system set up page to select the control panel firmware.

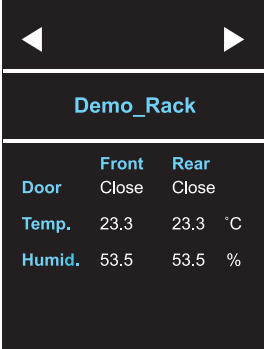
- ①  Touch the control panel

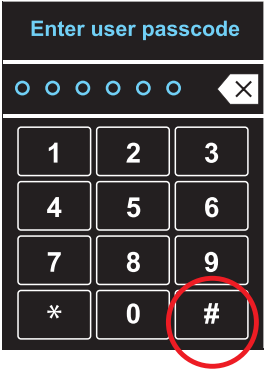
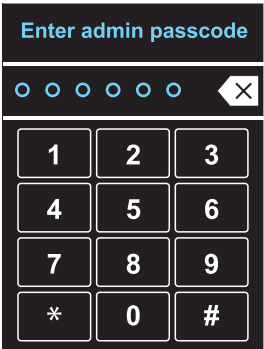
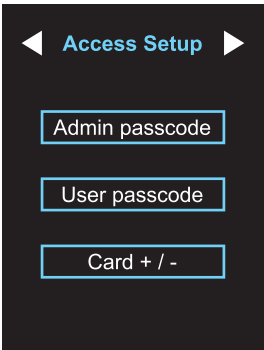
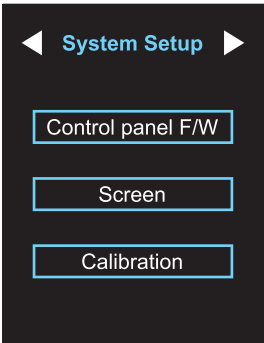
	Front	Rear
Door	Close	Close
Temp.	23.3	23.3 °C
Humid.	53.5	53.5 %
- ②  Press " #" for 10 seconds in " Enter user passcode " page
- ③  Input admin passcode to enter " Access Setup " page
- ④  Press " ◀ " or " ▶ " to " System Setup " page
- ⑤  Select " Control panel F/W "

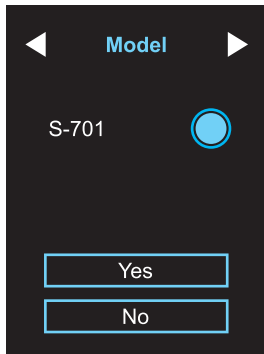
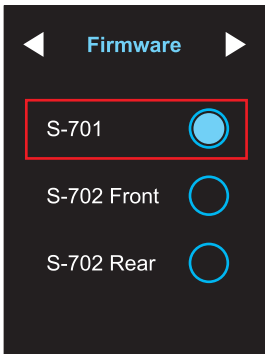

1. For S-701 model, simply select " S-701 " in the " Firmware " page.
Press " Yes " to confirm in the " Model " page.
The control panel will reboot to make the change effective.

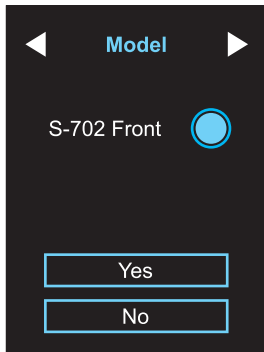
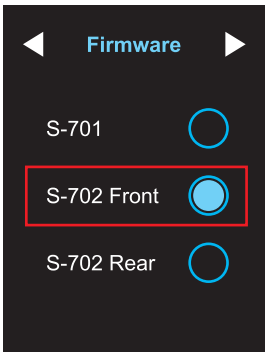

2. For S-702 model, select " S-702 Front " for the control panel on the front door in the " Firmware " page.
Press " Yes " to confirm in the " Model " page.
The control panel will reboot to make the change effective.

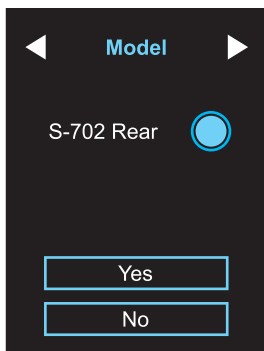
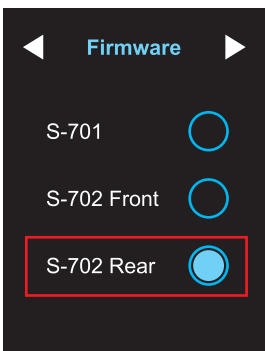

For S-702 model, select " S-702 Rear " for the control panel on the rear door in the " Firmware " page.
Press " Yes " to confirm in the " Model " page.
The control panel will reboot to make the change effective.

< 5.3 > User Passcode Assignment

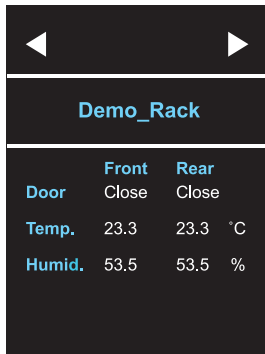

1. Touch the control panel

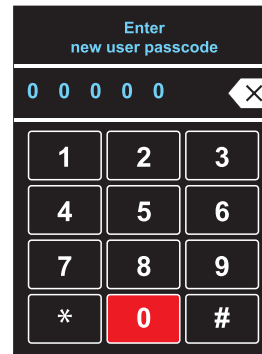

5. Input the new user passcode
(default : 000000)

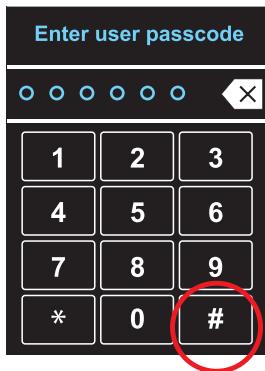

2. Press “ # “ for 10 seconds
in “ Enter user passcode “
page

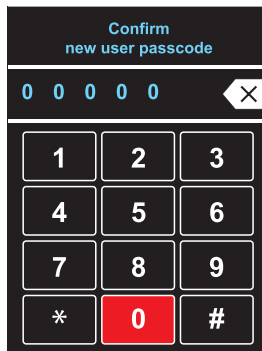

6. Input the new user passcode
again to confirm

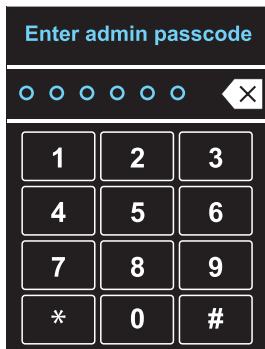

3. Input admin passcode to
enter " Access Setup " page

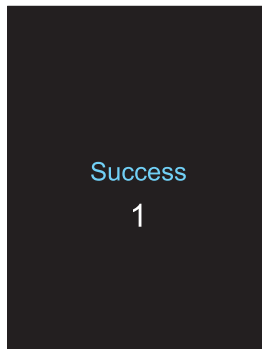

7. " Success " page show up
5 seconds

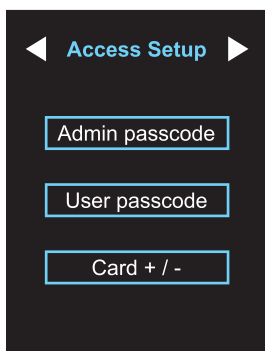

4. Select " User passcode "

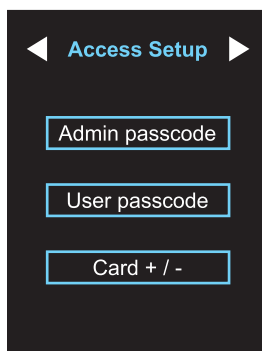

8. Return to " Access Setup " page

< 5.4 > User Card Addition

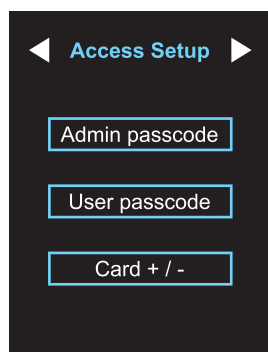

1. Select " Card + / - "

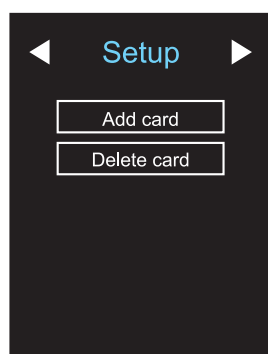

2. Select " Add card "

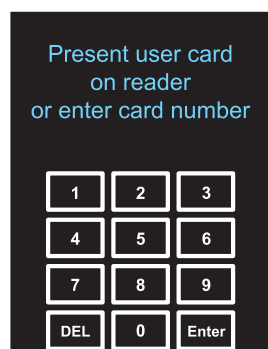

3. Present the user card to the sensor area or input the card no. and press " Enter "

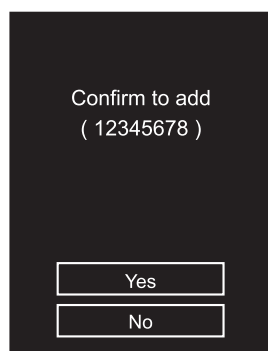
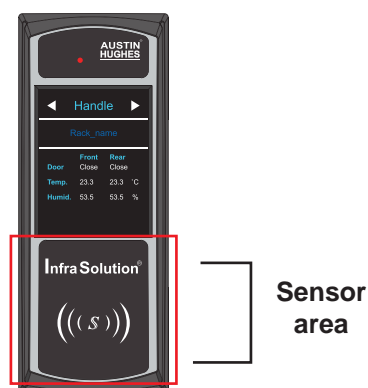

4. Press " Yes " to confirm or " No " to cancel



Repeat step 3 & 4 to add more user card (max. 50 user card)



If no user card is assigned to the control panel , you can open the door by user passcode ONLY

< 5.5 > Screen

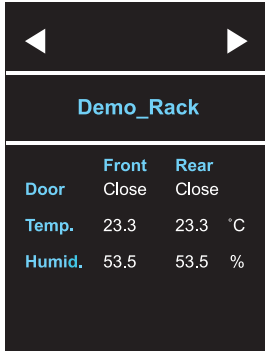

1. Present a valid card to the control panel

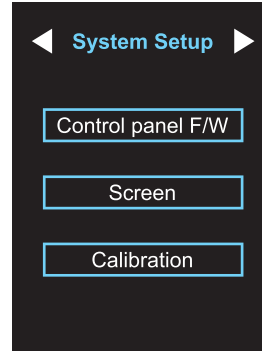

5. Select " Screen "

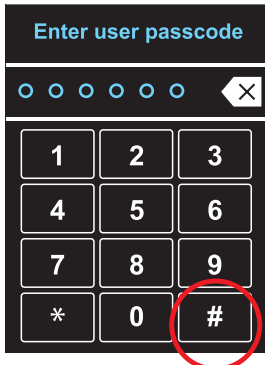

2. Press " # " for 10 seconds in " Enter user passcode " page

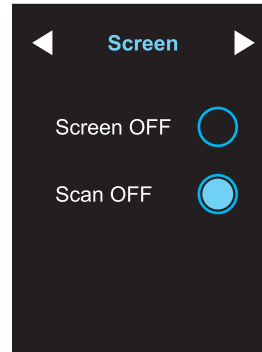

6. **Default : Screen < ON >**
Scan < OFF >

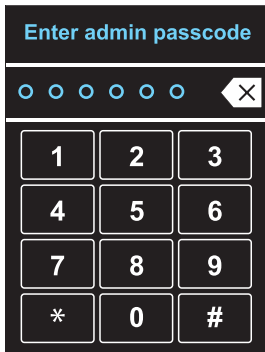

3. Input admin passcode to enter " Access Setup " page

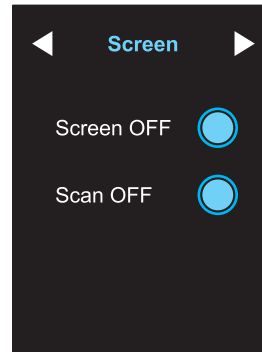

7. * **OFF Screen :**

- Screen OFF in 30 seconds
- If want to turn on the screen just touch it
- OFF in 30 seconds if no any further touch

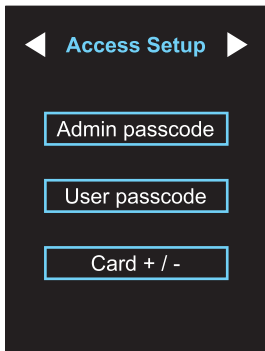

4. Press " ◀ " or " ▶ " to " System Setup " page

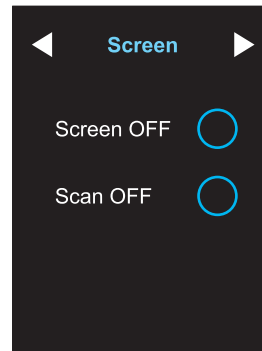

8. * **ON Scan :**

- Scanning starts in 30 seconds
- Then scan each page per 3 seconds

< 5.6 > Calibration

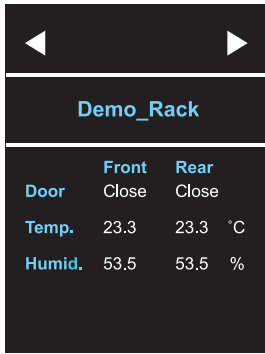

1. Present a valid card to the control panel

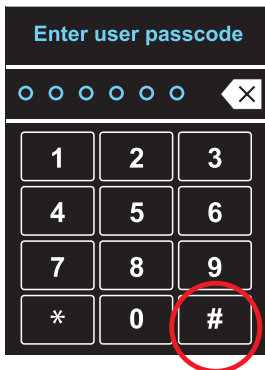

2. Press " # " for 10 seconds in " Enter user passcode " page

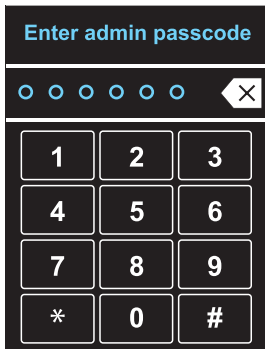

3. Input admin passcode to enter " Access Setup " page

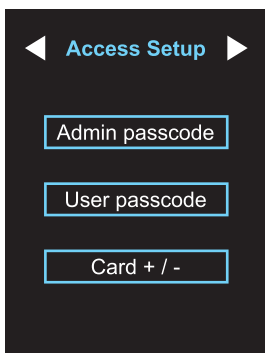

4. Press " ◀ " or " ▶ " to " System Setup " page

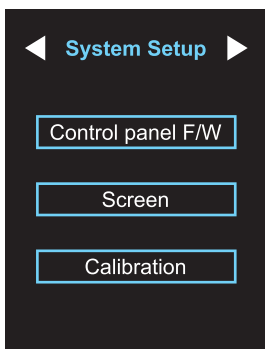

5. Select " Calibration "

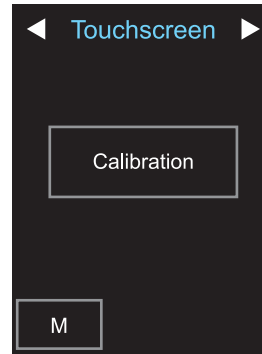

6. Touchscreen Calibration

 If no any calibrate touch in 30 seconds , it will return to Touchscreen page

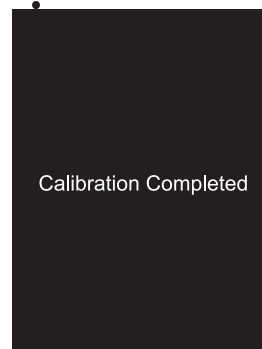
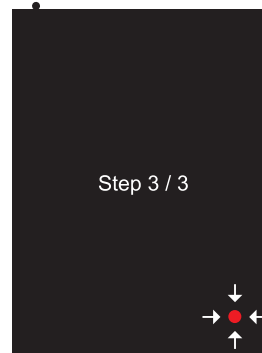
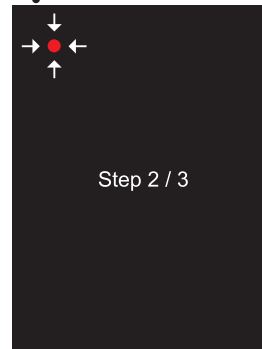
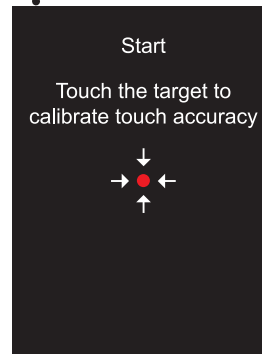

Part VI. Utilities ISU-01

< 6.1 > Software Features & Hardware Requirements

Software Features

	Utilities ISU-01
Max. 50 user card authentication per control panel	✓
Change of Admin. Passcode	✓
Change of User Passcode	✓
Card Assignment	✓

Hardware Requirements

Please prepare a notebook computer with the hardware specifications as below for InfraSolution S Utilities ISU-01.

Recommended hardware :

- Processor: Dual Core 2GHz or above
- Memory: 2GB RAM
- Available Disk Space: 2GB
- Display: 1024 x 768 or higher resolution



USB port x 1 required for the data input cable & smartcard handle configuration

< 6.2 > Supported OS Platform & Language

Supported OS platform & language list :

- MS Windows 7 Professional with SP1 (32bit & 64bit, English edition only)
- MS Windows 10 Professional (64bit, English edition only)

User can select the following languages under Control Panel > Region and Language in English Edition OS:

- 1) Arabic (Saudi Arabia)
- 2) Chinese (Traditional, Hong Kong S.A.R.)
- 3) Dutch (Netherlands)
- 4) English (Australia)
- 5) English (United Kingdom)
- 6) English (United States)
- 7) French (France)
- 8) German (Germany)
- 9) German (Switzerland)
- 10) Italian (Italy)
- 11) Japanese (Japan)
- 12) Korean (Korea)
- 13) Norwegian (Norway)
- 14) Portuguese (Portugal)
- 15) Russian (Russia)
- 16) Spanish (Spain)
- 17) Turkish (Turkey)

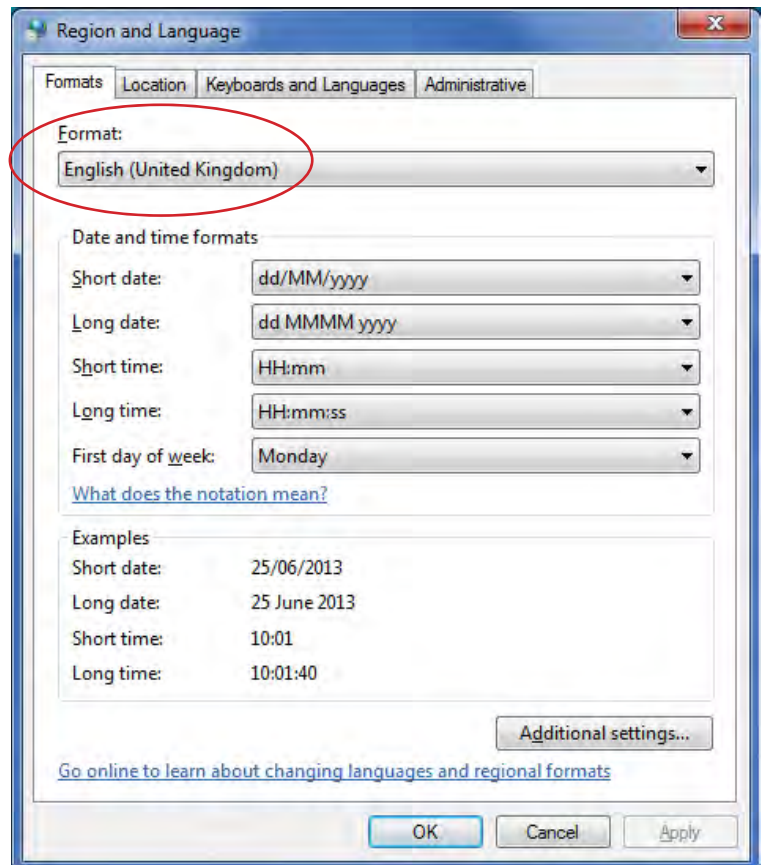

< 6.3 > Utilities ISU-01 Download & Installation

After the handle installation, please take the following steps to install the utilities :

1. Prepare a notebook computer to download the handle setup utilities from the link :
<http://www.austin-hughes.com/support/utilities/infrasolutionS/ISU-01.msi>



2. Double click the ISU-01.msi and follow the instruction to complete the installation.



↓
click “ **Next** ”

↓
click “ **Install** ”

↓
click “ **Finish** ”

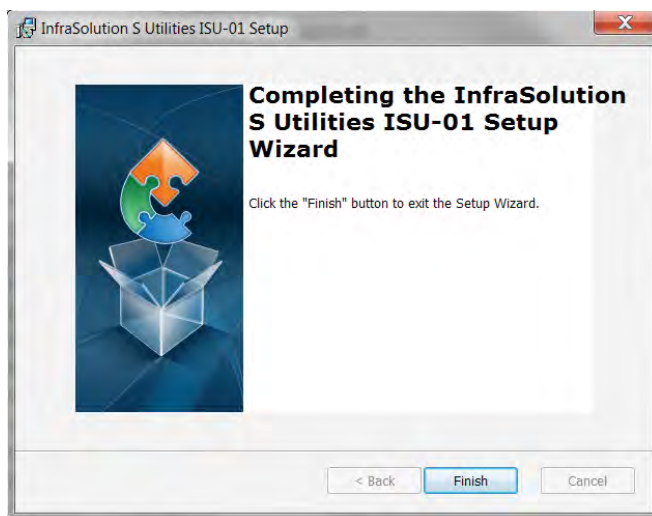

..... **Complete**

< 6.4 > Driver Installation for Data Input Cable

Before initial configuration for control panel, user **MUST** install the driver for the data input cable **ONCE**. Please follow 13 steps below to complete the installation.

Step 1.

Connect the control panel to the notebook computer via the control panel data input cable (ISW-USB-1.8).

 Make sure the control panel in power ON status

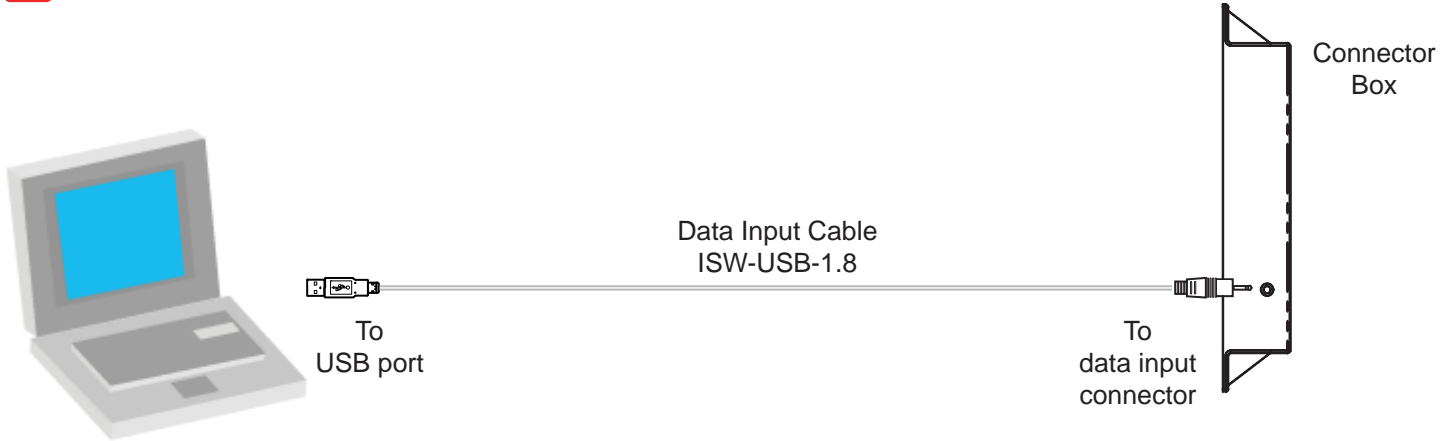

 If the notebook is MAC model, users may need to download the USB driver to run Windows OS under MAC notebook PC.

<http://www.austin-hughes.com/support/utilities/infrasolutionS/ISW-USBV20828-32bit.7z>

OR

<http://www.austin-hughes.com/support/utilities/infrasolutionS/ISW-USBV20828-64bit.7z>

Step 2.

Right click " **My computer** " & Select " **Manage** ". Click " **Device Manager** ". Then user can see an improper USB UART driver installed under " **Other devices** " .

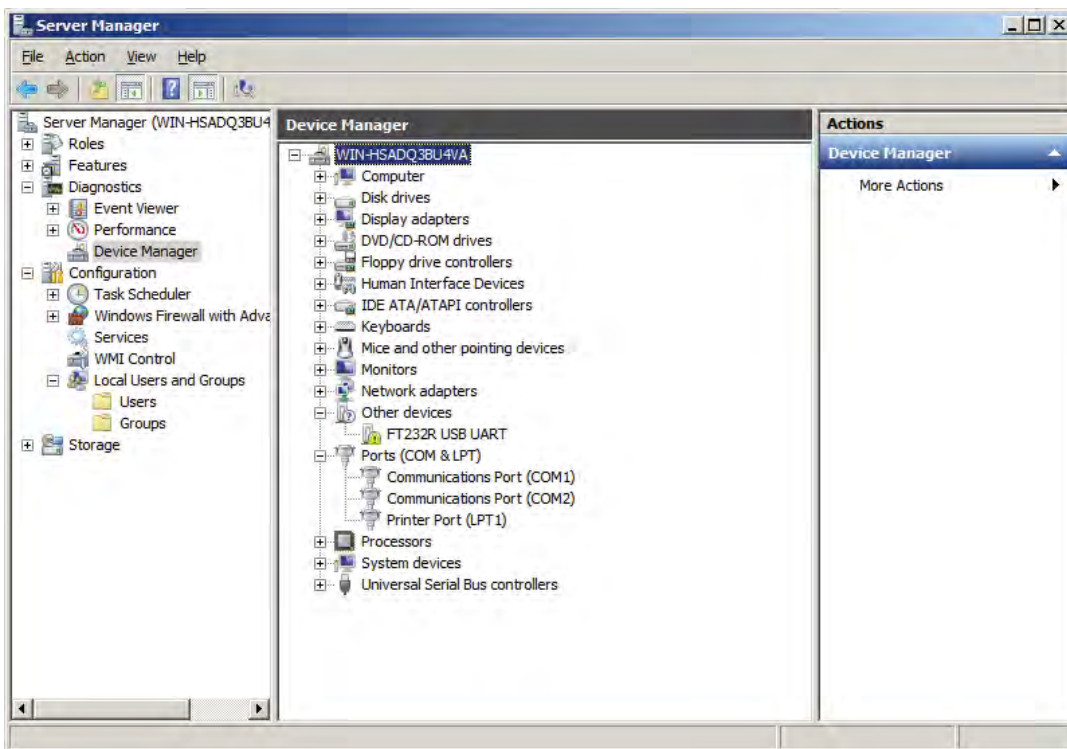

< 6.4 > Driver Installation for Data Input Cable

Step 3.

Right Click the improper installed **USB UART** driver & Select “ **Update Driver Software...** ”.

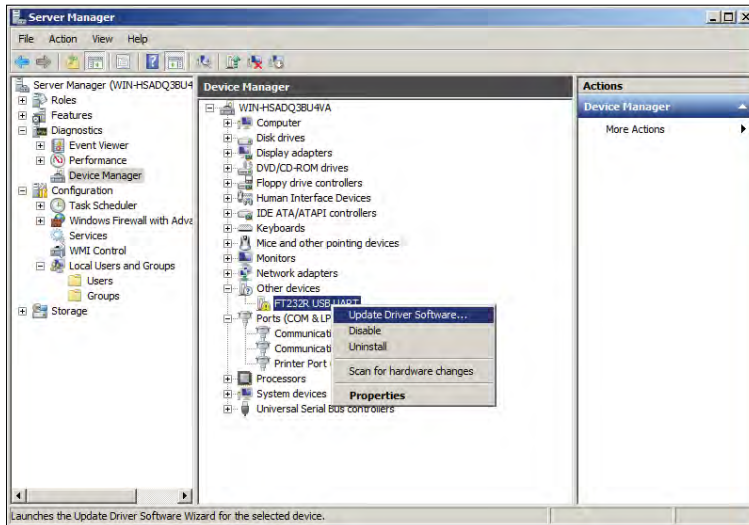

Step 4.

A window pops up & please Select “ **Browse my computer for driver software** ”.



Step 5.

Click “ **Browse** ” to search the path of the driver software.

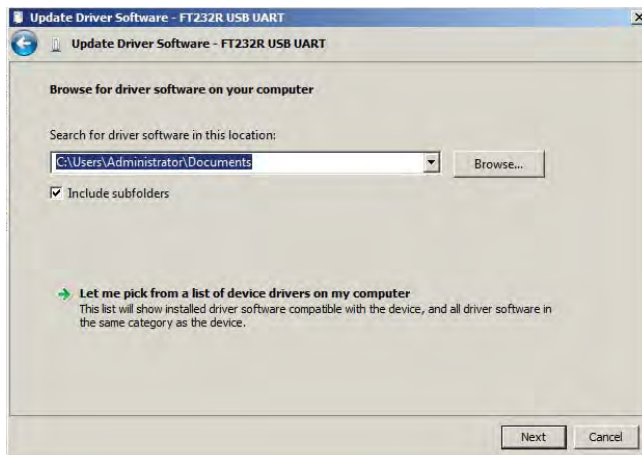

< 6.4 > Driver Installation for Data Input Cable

Step 6.

Select C:\ > Program Files > InfraSolution S – Setup Utilities > Driver & Click “ OK “

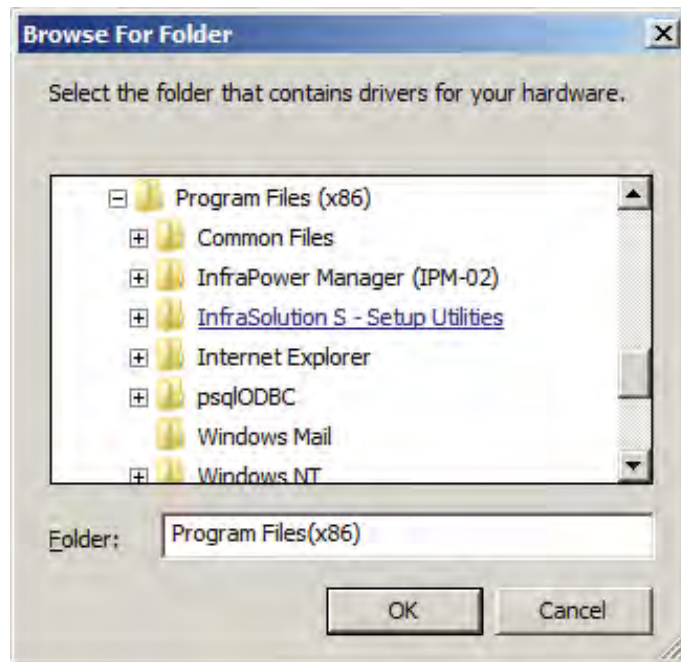

Step 7.

Click “ Next “ to install the driver.



Step 8.

It takes a few seconds to complete. When complete, Click “ Close “



Step 9.

“ USB Serial Converter “ shows under “ Universal Serial Bus controllers ”.

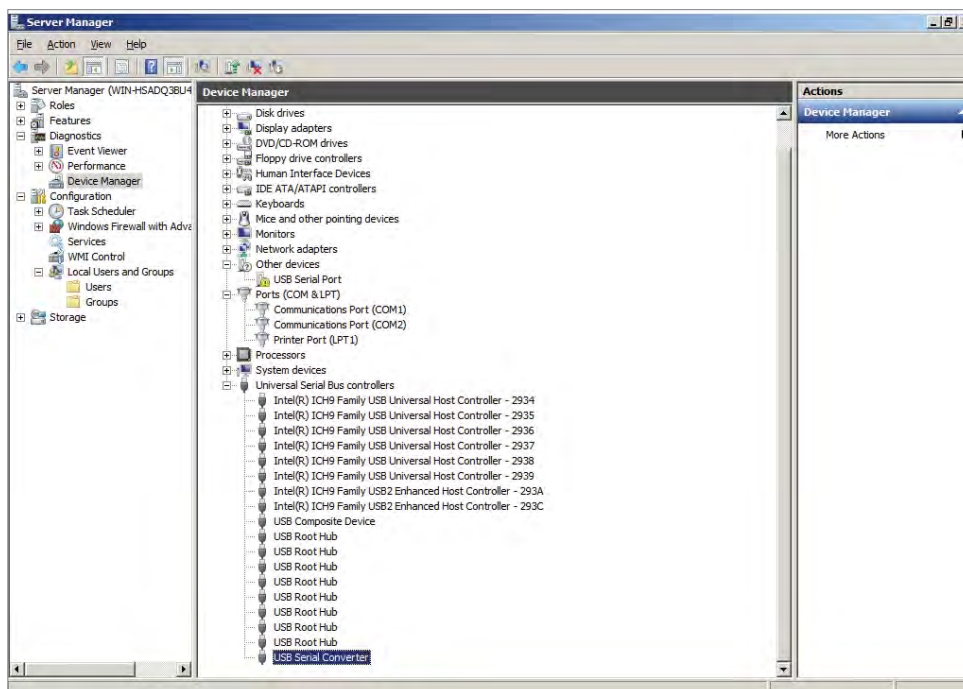

< 6.4 > Driver Installation for Data Input Cable

Step 10.

Right Click “ **USB Serial Port** “ under “ **Other devices** “ & Select “ **Update Driver Software...** ”.

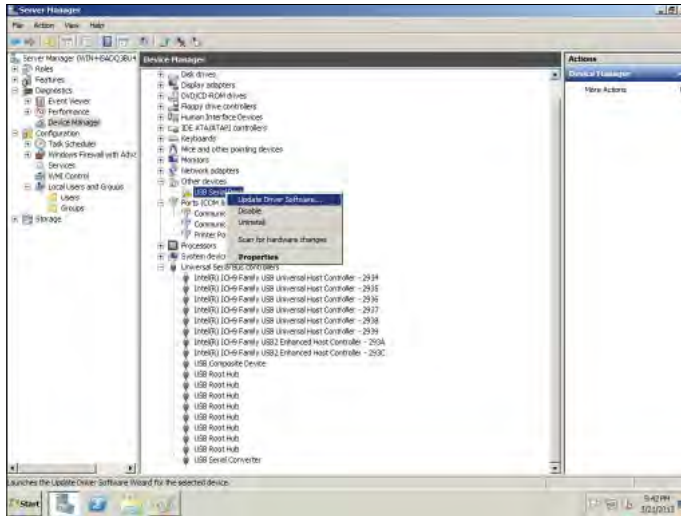

Step 11.

Select “ **Browse my computer for driver software** “.

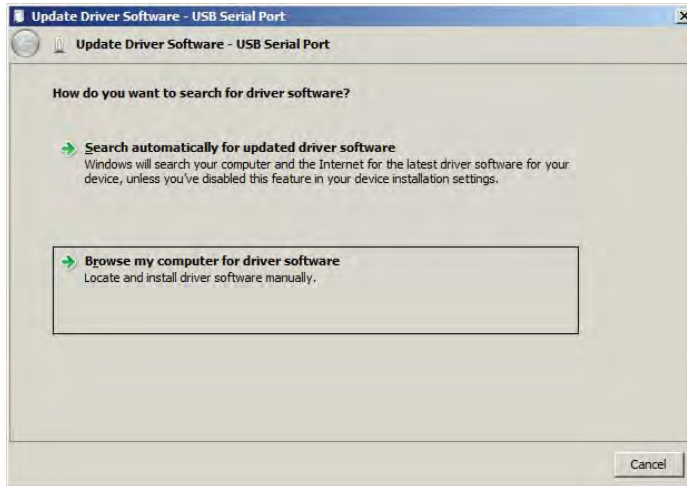

Step 12.

Click “ **Browse** “ to search the correct path of the driver software & Click “ **Next** “ to install the driver.

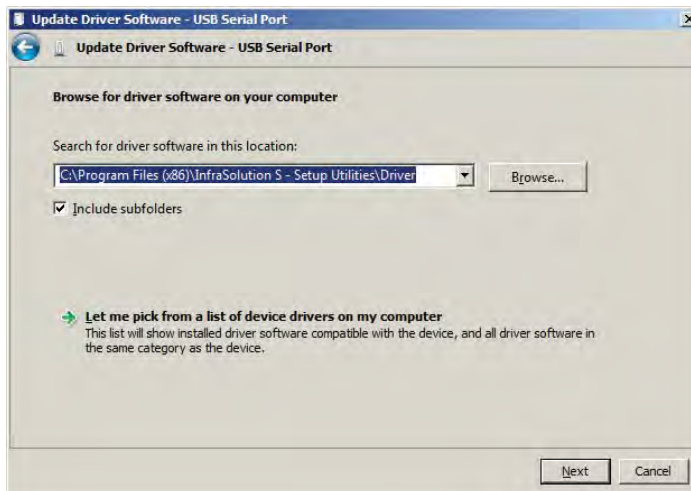

Step 13.

It takes a few seconds to complete. When complete, Click “ **Close** ”

..... **Complete**

< 6.5 > Initial Control Panel Configuration

 Please take the following steps to run the ISU-01 as an administrator :

After hardware & software installation, please take the following steps to configure the control panel.

- (1) Prepare the notebook computer installed with utilities ISU-01
- (2) Connect to the control panel via the control panel data input cable (ISW-USB-1.8)
- (3) Make sure the control panel in power ON status
- (4) Configure the control panel according to the UI
- (5) After finish the control panel configuration, please repeat the steps for other control panels **One by One**

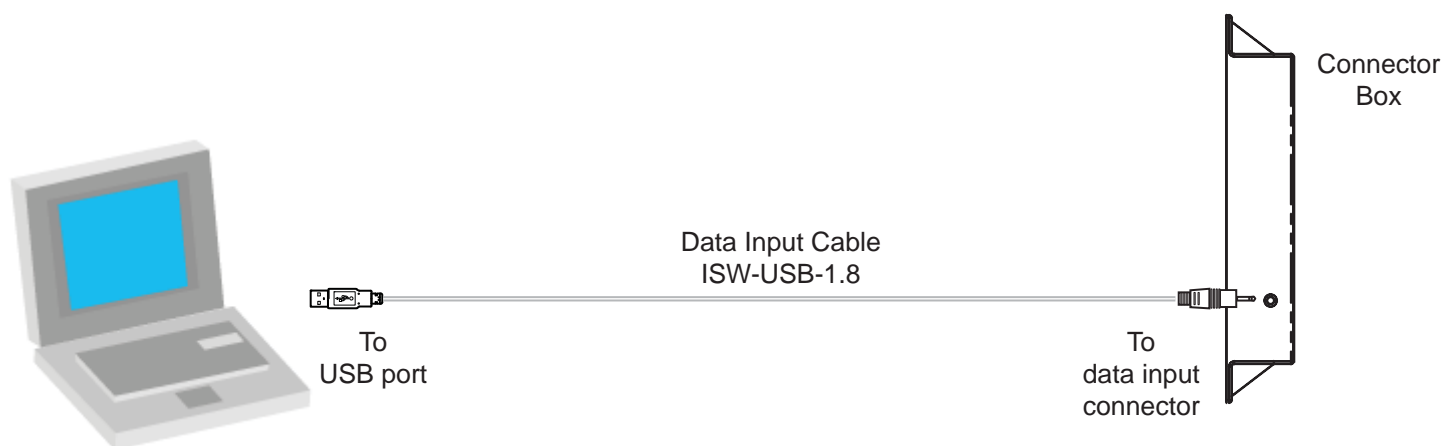

-  To run the ISU-01 as an administrator, please follow the steps below :
- Right Click **InfraSolution S Utilities ISU-01** , and then Select “ **Properties** ”.
 - Click the “ **Compatibility** ” tab.
 - Tick the box “ **Run this program as an administrator** ”, and then Click “ **OK** ” .

If don't take the above steps, the UI will not display properly.

< 6.5 > Initial Control Panel Configuration

InfraSolution S Utilities ISU-01 Version: Q417V9

Control Panel Information

ID: SHID170731115543
Model: S-702M
Type: MiFARE
Last updated: 2017 / 12 / 06 15:40

Control Panel

Name: AHE
Rack: Demo_Rack
Calendar Sync: Enable

Admin Passcode (Setup)

New Admin passcode:

User Passcode (Authen.)

New User passcode:

Buttons: Apply, Cancel, Export, Import

Status:

Card Assignment (Max. 50)

Card No.	Card ID	Assignment
1	92103172	
2	60931588	
3	25691396	
4	53922640	
5	94945130	
6	67751684	
7	20684542	
8	20927838	
9		
10		
11		
12		
13		
14		
15		
16		
17		
18		
19		
20		
21		
22		
23		
24		
25		
26		
27		
28		
29		
30		
31		
32		
33		
34		
35		
36		
37		
38		
39		
40		
41		
42		
43		
44		
45		
46		
47		
48		
49		
50		

Control panel Information

In < **Control panel Information** >, shows the control panel ID #, model, card type & the time of last configuration.

Control Panel Information

ID: SHID170731115543
Model: S-702M
Type: MiFARE
Last updated: 2017 / 12 / 06 15:52

< 6.5 > Initial Control Panel Configuration

Control Panel

In < **Control Panel** >, record the **Name** (default is empty) and **Rack** (default : Demo_Rack) of the control panel.
After saving the record, **Name** is shown on Main page while **Rack** on Main page and PDU page
Tick “ **Enable** ” to synchronize the timer of control panel with the computer

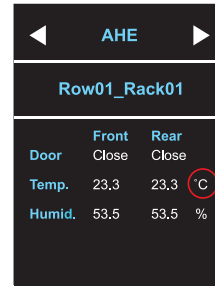
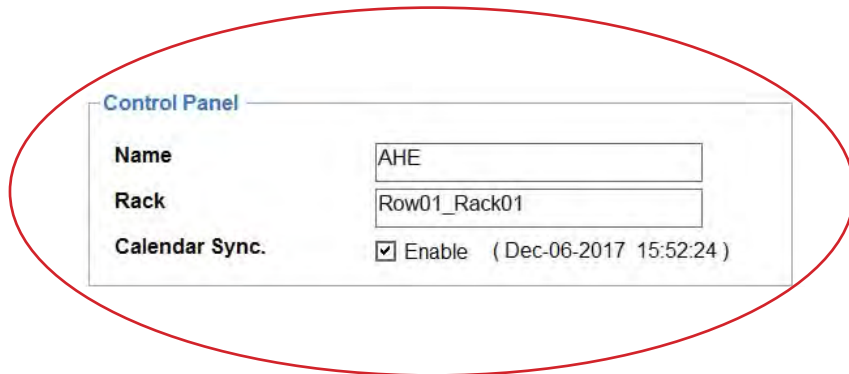

Door	Front Close	Rear Close
Temp.	23.3	23.3 C
Humid.	53.5	53.5 %

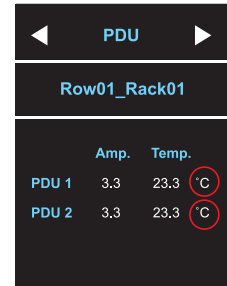

Amp.	Temp.
PDU 1	3.3 23.3 C
PDU 2	3.3 23.3 C



Touch °C / °F to change temp. unit

Admin Passcode

In < **Admin Passcode** >, input the **New Admin Passcode** and **Confirm Admin Passcode** of the control panel.
(default : 000000)

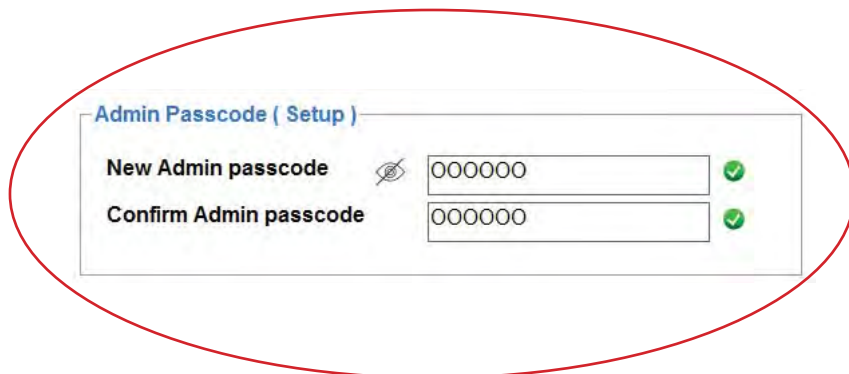

User Passcode

In < **User Passcode** >, input the **New User Passcode** and **Confirm User Passcode** of the control panel.
(default : 000000)



< 6.6 > User Card Assignment

In < **Card Assignment** >, assign, edit or delete user card.

The screenshot shows a web interface titled 'Card Assignment (Max. 50)'. At the top right, there are two buttons: 'Card Edit' and 'Delete'. Below the title is a table with two columns of card numbers. The first column contains numbers 1 through 5, and the second column contains numbers 26 through 32. Each number is followed by a text input field. The input fields for 1, 2, 3, and 4 contain the numbers 20927838, 20684542, 53922640, and 92103172 respectively. The input field for 5 contains 25691396. The input field for 26 contains 751684. The input fields for 27 through 32 are empty.

Card No.	Card Number	Card No.	Card Number
1	20927838	26	751684
2	20684542	27	
3	53922640	28	
4	92103172	29	
5	25691396	30	
		31	
		32	

Card Assignment by two methods

- (1) Click **Card Edit**, then direct input the last 8 digits of the card number to the field
- (2) Click **Card Edit**, then present the smartcard to the sensor area of the control panel and the last 8 digits of the card number will be input to the field simultaneously & automatically

Card no. Change

- (1) Click **Card Edit**, then change the existing card numbers in the field

Card Delete

- (1) Click **Card Edit**, then delete the card number in the field one by one

All Card Delete

- (1) Click **Delete**, then confirm this command and all card assignment will be deleted



Click “ **Apply** ” to finish the above configuration for smartcard.



If no user card is assigned to the control panel , you can open the door by user passcode ONLY

< 6.7 > Export & Import of Control Panel Configuration

In < **Export** > and < **Import** >, provide a quick way to configure other control panel with same or similar configuration on < **Control Panel** >, < **Admin Passcode** >, < **User Passcode** > and < **Card Assignment** >.

Steps for **Export** :

- (1) Click “ **Export** ” and Click “ **Yes** ” from the pop up window
- (2) Provide the name and path of the export file and follow the instruction to complete the export

InfraSolution S Utilities ISU-01

Control Panel Information

ID	SHID170731115543
Model	S-702M
Type	MIFARE
Last updated	2017 / 12 / 06 15:52

Control Panel

Name	AHE
Rack	Demo_Rack
Calendar Sync.	<input checked="" type="checkbox"/> Enable (Dec-06-2017 15:52:24)

Admin Passcode (Setup)

New Admin passcode	<input type="password" value="000000"/>	✓
Confirm Admin passcode	<input type="password" value="000000"/>	✓

User Passcode (Authen.)

New User passcode	<input type="password" value="000000"/>	✓
Confirm user passcode	<input type="password" value="000000"/>	✓

Apply Cancel **Export** Import

Status:

< 6.7 > Export & Import of Control Panel Configuration

Steps for **Import** :

- (1) Select the control panel which you want to import control panel configuration file
- (2) Connect the control panel to the notebook computer via the data input cable (ISW-USB-1.8)
- (3) Click " **Import** " and Click " **Yes** " from the pop up window
- (4) Select the file to import & follow the instruction to complete the import step
- (5) After import completed, edit the field (s) on **Name** , **Rack** if necessary
- (6) Click " **Apply** " to finish file import

InfraSolution S Utilities ISU-01

Control Panel Information

ID	SHID170731115543
Model	S-702M
Type	MiFARE
Last updated	2017 / 12 / 06 15:52

Control Panel

Name	<input type="text" value="AHE"/>
Rack	<input type="text" value="Demo_Rack"/>
Calendar Sync.	<input checked="" type="checkbox"/> Enable (Dec-06-2017 15:52:24)

Admin Passcode (Setup)

New Admin passcode	<input type="password" value="000000"/>	✓
Confirm Admin passcode	<input type="password" value="000000"/>	✓

User Passcode (Authen.)

New User passcode	<input type="password" value="000000"/>	✓
Confirm user passcode	<input type="password" value="000000"/>	✓

Apply Cancel Export **Import**

Status:

Intentionally Left Blank

Part VII. Control Panel & Handle Operation

< 7.1 > Two Important Notes

Important Note for Key lock

- ⚠ Under Smartcard mode, always keep key cylinder to 12 o'clock direction.

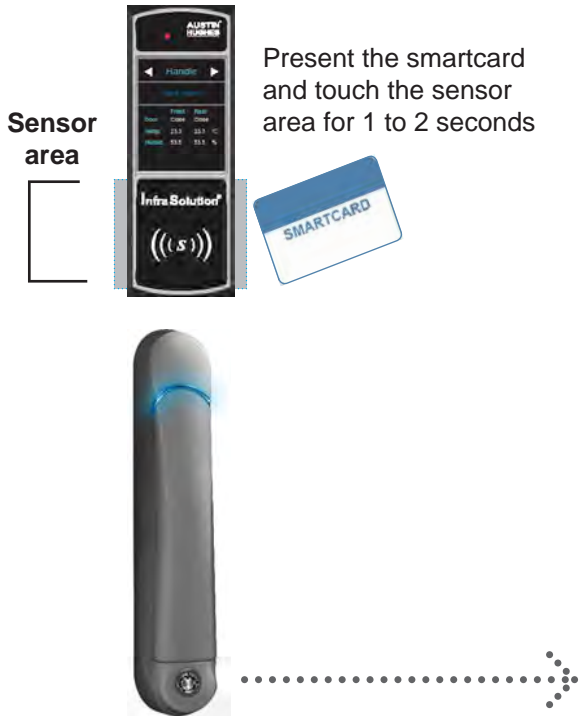

		Key lock mode Key cylinder to 9 o'clock direction Under key lock mode, even present the smartcard, the handle still keeps locked.
		Key unlock mode Key cylinder to 3 o'clock direction Under key unlock mode, the handle keeps unlocked.
		Smartcard mode ⚠ For smartcard operation, keep key cylinder always to 12 o'clock direction .

- ⚠ Unless the control panel or the handle is defective, lock / unlock the handle by key is NOT recommended
- Please insert & turn the key with push force



		Key lock mode Key cylinder to 9 o'clock direction .
		Key unlock mode Key cylinder to 3 o'clock direction .

< 7.1 > Two Important Notes

Maintenance Key (MK-001)

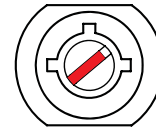

- Improper key usage may cause the cylinder stuck at abnormal direction 1 to 2 o'clock.
- Under this circumstance, the **maintenance key (MK-001)** is required to solve the problem.
- Please insert the **maintenance key** to the cylinder with push force for turning it to normal direction 9 or 12 or 3 o'clock.



< 7.2 > Control Panel & Handle Operation

How to unlock the handle & open the door properly

Locked status in



blue or green

Unlocked status in



+
Passcode
Input



silver white
flashing



silver white



Within 10 seconds, users should :
- lift up and swing the handle
- open the door

NOT open the door after authentication within 10 seconds



silver white
flashing



10 seconds



red



30 seconds



blue or green

Over 10 seconds

- ① Red
- ② Attention shown on the control panel

Over 30 seconds

- ① Auto-lock
- ② Return to blue or green

< 7.2 > Control Panel & Handle Operation

Unauthorized door-open

Locked status in

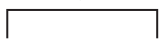

blue or green

Door Open by force
without authentication

Unlocked status in

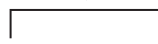

red
flashing



- ① The handle LED will turn to **red flashing** with audio alarm 'beep' sound.
- ② Alarm shown on the control panel

How to close the door properly

Unlocked status in



silver white



To close the door

Locked status in



blue or green



- Users should :
- close the door
 - swing and return the handle to park position properly
 - the handle will **auto-lock**

Part VIII. FAQ & Troubleshooting

FAQ

Utilities – ISU-01

1. What is Utilities – ISU-01 ?

- ISU-01 is a Windows based utility to provide a simple & user friendly way for initial handle setup

2. Which OS platform does ISU-01 support ?

- MS Windows 7 Professional with SP1 (32bit & 64bit, English edition only)

- MS Windows 10 Professional (64bit, English edition only)

3. Why the control panel no. NOT show in UI ?

- ensure the control panel is in power ON status

- ensure the driver installation for data input cable (ISW-USB-1.8) completed

Control Panel & Handle

1. How many user card can I assign to each control panel ?

- up to 50

2. Why can't open the door even I presented a valid user card to the control panel ?

- ensure the handle lock under the smartcard mode that key cylinder at 12 o'clock direction.

Please refer user manual " < 7.1 > Two Important Notes " .

3. What Reader format does your control panel support ?

- 125kHz (HID 26-bit system) / 13.56MHz (MIFARE)

4. What MIFARE standard does your reader support ?

- The CSN of MIFARE Classic , MIFARE DESFire EV1 , MIFARE DESFire EV2, MIFARE Plus S, MIFARE Plus X and MIFARE Plus EV1

Others

1. How to do if lost the user card ?

- Open the door by key and edit the card assignment via ISU-01

- Delete the lost user card in “ Setup “ page on the Control Panel

2. Where can I get the USB driver for the data input cable (ISW-USB-1.8) ?

- for 32 bit OS : <http://www.austin-hughes.com/support/utilities/infrasolutionS/ISW-USBV20828-32bit.7z>

- for 64 bit OS : <http://www.austin-hughes.com/support/utilities/infrasolutionS/ISW-USBV20828-64bit.7z>

3. Where can find the Catalog / User manual / Model list of Rack Smart Card Handle ?

- please visit www.austin-hughes.com

4. How can get further support ?

- please send email to support@austin-hughes.com or sales@austin-hughes.com

Part VIII. FAQ & Troubleshooting

Troubleshooting

1. Control panel ID no. not shown in UI

Step 1 - Control panel is OFF ?

ensure the control panel is in power ON status

Step 2 - Check the driver of the data input cable installed properly ?

ensure the driver is installed properly. Please refer to user manual " < 6.4 >

Driver installation for Data Input Cable "

Step 3 - Check the USB port of the notebook computer ?

Try to plug the data input cable into another USB port of the notebook computer.

Step 4 - Data input cable defective ?

Replace another data input cable.

2. Handle can't be locked after closed the door

Step 1 - Check door sensor is installed ?

If NO door sensor is installed, the handle CANNOT be locked after you unlock it.

Step 2 - Door sensor sensing distance when door close greater than 10mm (IR door sensor only) ?

Ensure the distance between the door sensor and rack frame is LESS than 8mm (black surface)
/ 25mm (surface with other colors). Please refer to user manual " < 4.5 > Door Sensor "

Step 3 - Handle lock under key unlock mode and key cylinder at 3 o'clock direction ?

Ensure the handle lock under the smartcard mode that key cylinder at 12 o'clock. Please refer to user manual " < 7.1 > Two Important Notes "

3. Control Panel & front handle is OFF

Step 1- Cat 5 cable between the Junction box and connector box is loose ?

Ensure the cable is plugged securely.

Step 2- The red & white colored connectors of the Connector box to control panel cable loose ?

Ensure the connectors are fixed in the female connectors of the connector box firmly.

Part IX. Accessories

IR LED light bar (CLB-SD-IR-101)

- Magnetic base for easy, fast and tool-less affix
- Low-profile design for limited rack space
- Auto ON / OFF by IR sensor

Data input cable, pc (ISW-USB-1.8)

- Connect the smartcard handle to the laptop for handle activation, data input & configuration

Individual key lock, set of two for front & rear door (ISK-C051)

- Up to 500 individual key-locks available

Unique key lock (ISK-UKL)

- Unique key dedicated to single project / customer regionally
- For project size over 500 racks

Proximity smartcard, pack of 10 (ISC-P10)

- Proximity 26-bit format
- Single card for multiple application
- Custom card layout available

MiFARE smartcard, pack of 10 (ISC-M10)

- MiFARE 26-bit format
- Single card for multiple application
- Custom card layout available

Proximity card reader (ISC-PCR)

- Proximity 26-bit smartcard compatible
- Convenient way for smartcard ID reading
- Driverless for easy installation

MiFARE card reader (ISC-MCR)

- MiFARE 26-bit smartcard compatible
- Convenient way for smartcard ID reading
- Driverless for easy installation

The company reserves the right to modify product specifications without prior notice and assumes no responsibility for any error which may appear in this publication.

All brand names, logo and registered trademarks are properties of their respective owners.

Copyright 2018 Austin Hughes Electronics Ltd. All rights reserved.