

# CL Series

## cable ladders and accessories

fully welded heavy-duty cable ladders and accessories

features:

- Ladder sections individually boxed with handles for ease of transport
- Compatible with most popular brands and accessories of cable ladders
- Works on both new and existing installations
- Highly scratch resistant, durable black powder coat
- A full line of hardware and accessories available
- UL Classified in the US and Canada

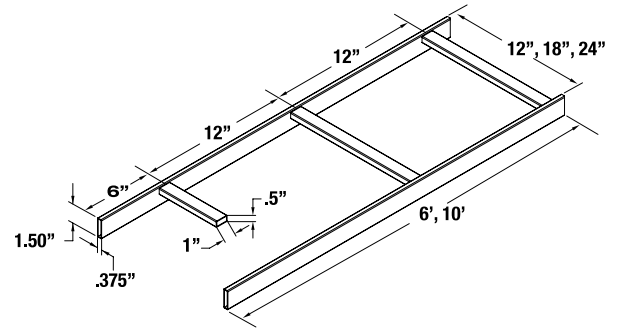

specifications:

### CLB-10 / CLB-6

Single piece \_\_\_(6', 10') \_\_\_ (refer to chart) long straight cable ladder sections shall be Middle Atlantic Products model # CLB-\_\_\_ (6, 10) \_\_\_ (refer to chart.) Ladder sections shall be \_\_\_(71", 119") long x \_\_\_(12", 18", 24") wide x 1.5" thick, rungs shall be 1" x .5" x \_\_\_" (11.25", 17.25", 23.25") tube. Ladder section shall have \_\_\_rungs on 12" centers. Ladder shall be constructed of ASTM A570 structural steel finished in a durable black powder coat. Each CLB series ladder section shall be individually boxed with handles. CLB Series cable ladder shall have up to 187 lb. weight capacity per foot based on a 4 ft. support span. Cable ladder shall be classified by UL in the US and Canada. Cable ladder shall be GREENGUARD Gold Certified. Cable ladder shall comply with the requirements of RoHS EU Directive 2002/95/EC. Cable ladder shall be manufactured by an ISO 9001 and ISO 14001 Registered Company. Cable ladder shall be warranted to be free from defects in material and workmanship under normal use and conditions for the lifetime of the product.

### CLB-90HB

90 degree horizontal bend cable ladder sections shall be Middle Atlantic Products model # CLB-90HB-\_\_\_ (refer to chart.) Ladder sections shall be \_\_\_ wide x 27" long x 1.5" thick, rungs shall be 1" x .5" x \_\_\_" (11.25", 17.25", 23.25") tube. Ladder bend section shall have four rungs on 5.2" centers on inside of bend and 10.25" centers on outside of bend. Bend section shall be constructed of ASTM A570 structural steel finished in a durable black powder coat. Each CLB series ladder section shall be individually boxed. CLB-90HB-\_\_\_ shall have up to 187 lb. weight capacity per foot based on a 4 ft. support span. Cable ladder shall be classified by UL in the US and Canada. Cable ladder shall be GREENGUARD Gold Certified. Cable ladder shall comply with the requirements of RoHS EU Directive 2002/95/EC. Cable ladder shall be manufactured by an ISO 9001 and ISO 14001 Registered Company. Cable ladder shall be warranted to be free from defects in material and workmanship under normal use and conditions for the lifetime of the product.

### CLB-VI90 / CLB-V090

90 degree vertical \_\_\_\_\_(inside, outside) bend cable ladder sections shall be Middle Atlantic Products model # CLB-\_\_\_(VI, VO) 90-\_\_\_. Ladder sections shall be \_\_\_(12", 18", 24") wide x 15.5" long x 1.5" thick, rungs shall be 1" x .5" x 11.25". Ladder bend section shall have 4 rungs on \_\_\_(4.8", 5.3") centers. Bend section shall be constructed of ASTM A570 structural steel finished in a durable black powder coat. Each CLB series ladder section shall be individually boxed. CLB-VI90 / CLB-V090 shall have up to 187 lb. weight capacity per foot based on a 4 ft. support span. Cable ladder shall comply with the requirements of RoHS EU Directive 2002 / 95 / EC. Cable ladder shall be classified by UL in the US and Canada. Cable ladder shall be GREENGUARD Gold Certified. Cable ladder shall be manufactured by an ISO 9001 and ISO 14001 Registered Company. Cable ladder shall be warranted to be free from defects in material and workmanship under normal use and conditions for the lifetime of the product.

Customizable specification clips available at [middleatlantic.com](http://middleatlantic.com)



PRODUCT CERTIFIED FOR  
LOW CHEMICAL EMISSIONS  
UL.COM/GG  
UL 2818

what **great systems** are built on.™

A brand of **legrand**

**Middle Atlantic Products**  
middleatlantic.com | middleatlantic.com

# CL Series

## cable ladders and accessories

all dimensions in inches unless otherwise noted [all dimensions in brackets are in millimeters]

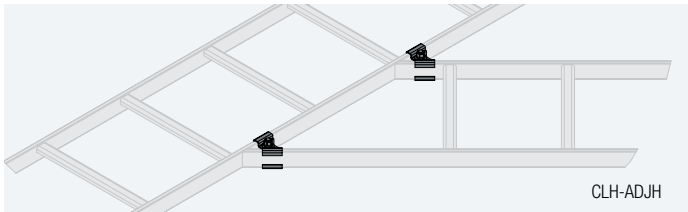

CLH-ADJH

Pair of adjustable horizontal splice hardware shall be Middle Atlantic Products model # CLH-ADJH. Hardware kit shall be of all steel construction with black zinc coating. Classified by UL in the US and Canada.

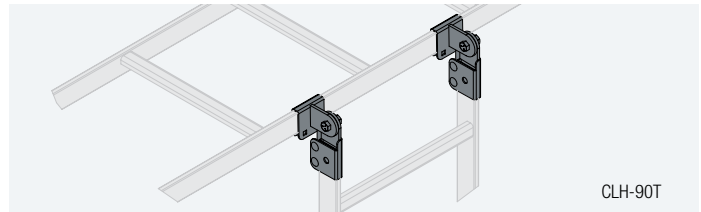

CLH-90T

Pair of adjustable 90 degree tee splice hardware shall be Middle Atlantic Products model # CLH-90T. Hardware kit shall be of all steel construction with black zinc coating. Classified by UL in the US and Canada.

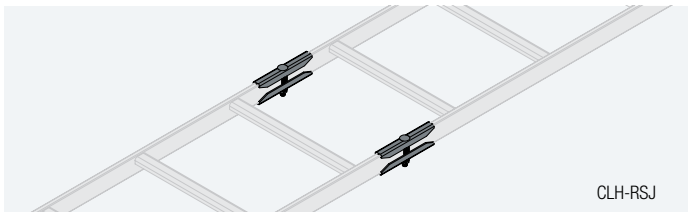

CLH-RSJ

Pair of ladder end splice hardware shall be Middle Atlantic Products model # CLH-RSJ. Hardware kit shall be of all steel construction with black zinc coating. Classified by UL in the US and Canada.

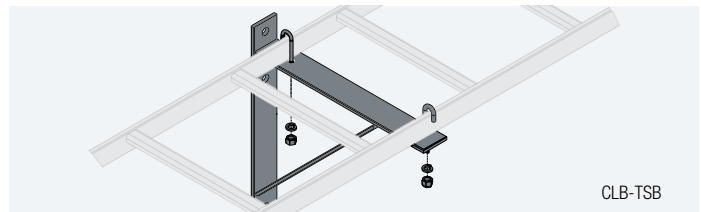

CLH-TSB

Triangle wall support brackets shall be Middle Atlantic Products model # CLH-TSB-\_\_\_. Hardware kit shall be of all steel construction with black powder coat finish.

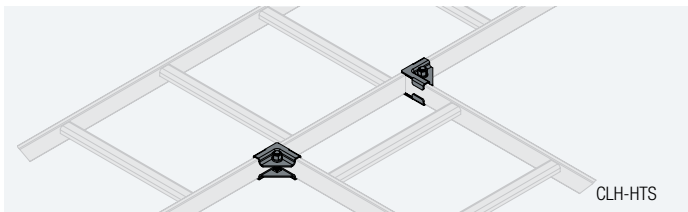

CLH-HTS

Pair of 90 degree horizontal tee splice hardware shall be Middle Atlantic Products model # CLH-HTS. Hardware kit shall be of all steel construction with black zinc coating. Classified by UL in the US and Canada.

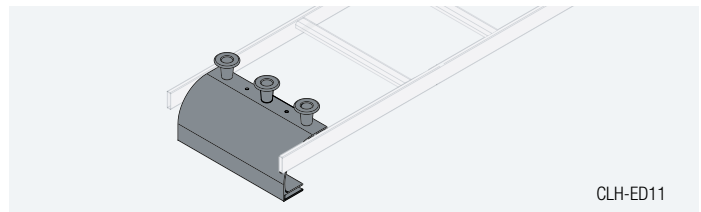

CLH-ED11

Cable ladder end/side drop with three cable spools shall be Middle Atlantic Products model # CLH-ED/SD-\_\_\_. End/side drop shall be of aluminum construction with black powder coat finish. Cable spools shall be black plastic. Classified by UL in the US and Canada.

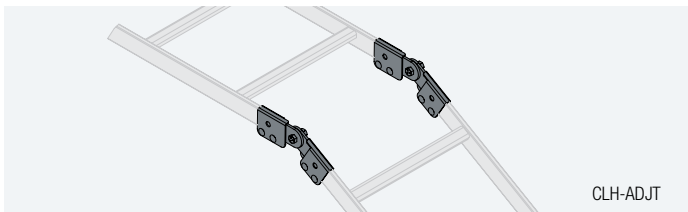

CLH-ADJT

Pair of adjustable ladder end splice hardware shall be Middle Atlantic Products model # CLH-ADJT. Hardware kit shall be of all steel construction with black zinc coating. Classified by UL in the US and Canada.

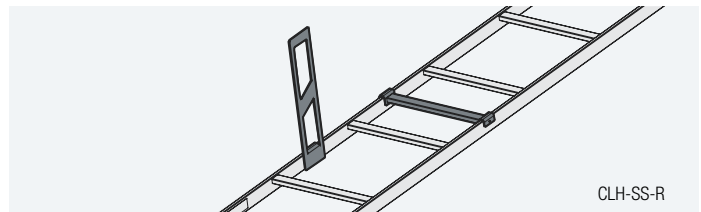

CLH-SS-R

Pair of 12" High stand-off shall be Middle Atlantic Products model # CLH-SS-12.

what **great systems** are built on.™

A brand of **legrand**

**Middle Atlantic Products**

[middleatlantic.com](http://middleatlantic.com) | [middleatlantic.ca](http://middleatlantic.ca)

# CL Series

## cable ladders and accessories

all dimensions in inches unless otherwise noted [all dimensions in brackets are in millimeters]



CLH-RWC

Pair of ladder wall clamps shall be Middle Atlantic Products model # CLH-RWC. Hardware kit shall be of all steel construction with black zinc coating.

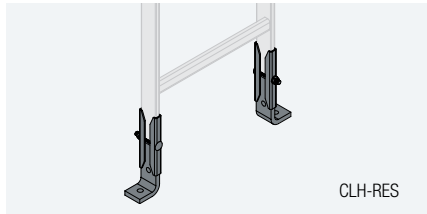

CLH-RES

Pair of ladder end support hardware shall be Middle Atlantic Products model # CLH-RES. Hardware kit shall be of all steel construction with zinc coating.



CLH-SPOOL-10

Pack of ten plastic cable spools shall be Middle Atlantic Products model # CLH-SPOOL-10. Cable spools shall be black plastic.

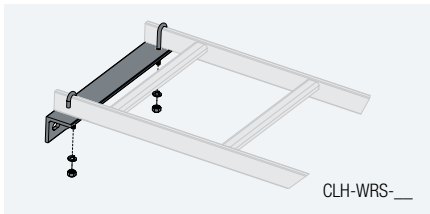

CLH-WRS-\_\_

Ladder wall support shall be Middle Atlantic Products model # CLH-WRS- \_\_ (refer to chart.) Hardware kit shall be of all steel construction with black powder coat finish. Shall also be available in a contractor pack of six pieces, model # CLH-WRS-6.

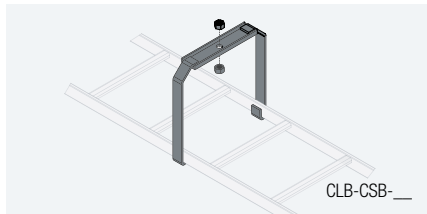

CLB-CSB-\_\_

Ladder center support brackets shall be Middle Atlantic Products model # CLB-CSB- \_\_ (refer to chart.) Hardware kit shall be of all steel construction with black powder coat finish.

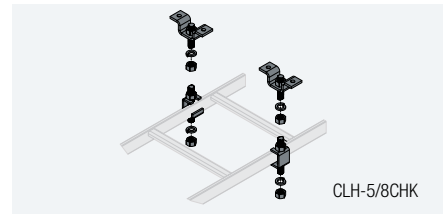

CLH-5/8CHK

Set of slotted ladder support hardware with ceiling hang kit shall be Middle Atlantic Products model # CLH-5/8CHK. Hardware kit shall be of all steel construction with black zinc coating.

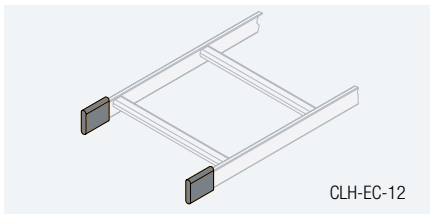

CLH-EC-12

Pack of six pairs of ladder end caps shall be Middle Atlantic Products model # CLH-EC-12. End caps shall be black rubber. Classified by UL in the US and Canada.

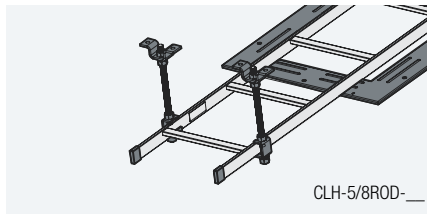

CLH-5/8ROD-\_\_

Adjustable 5/8" threaded rod shall be Middle Atlantic Products model # CLH-5/8ROD-12-4 (four 12" long pieces), CLH-5/8ROD-6 (one 6' length)

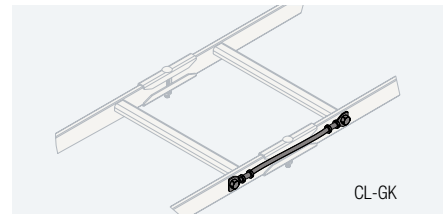

CL-GK

Cable ladder bonding kit shall be Middle Atlantic Products model # CL-GK. Classified by UL in the US and Canada.

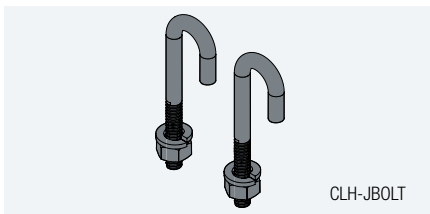

CLH-JBOLT

Pair of J-Bolts shall be Middle Atlantic Products model # CLH-JBOLT

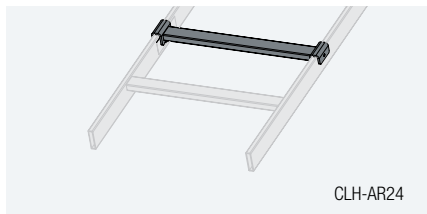

CLH-AR24

Adjustable rung shall be Middle Atlantic Products model # CLH-AR\_\_\_ (12", 18", 24")

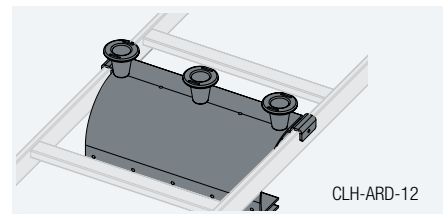

CLH-ARD-12

Adjustable rung drop shall be Middle Atlantic Products model # CLH-ARD-\_\_\_ (12", 18", 24")

what **great systems** are built on.™

A brand of **legrand**

**Middle Atlantic Products**

middleatlantic.com | middleatlantic.ca

# CL Series

## CLB basic dimensions

all dimensions in inches unless otherwise noted [all dimensions in brackets are in millimeters]

front view

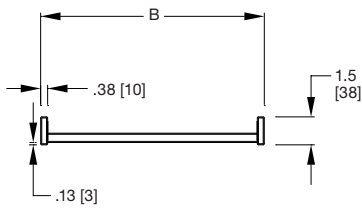

Cable Ladder Weight Capacity

Support Span	Weight Rating per Foot [meter]
4 ft. [1.2m]	187 lbs. [26 kg]
5 ft. [1.5m]	119 lbs. [16 kg]
6 ft. [1.8m]	83 lbs. [11 kg]
7 ft. [2.1m]	62 lbs. [9 kg]
8 ft. [2.4m]	50 lbs. [7 kg]

top view

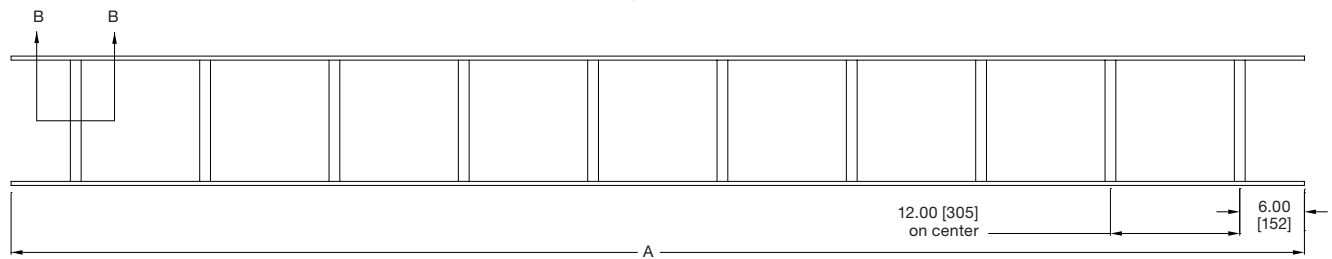

section B-B

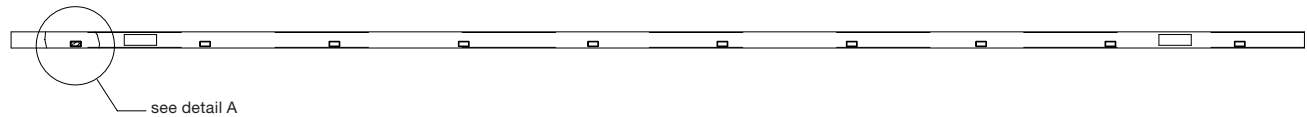

detail A

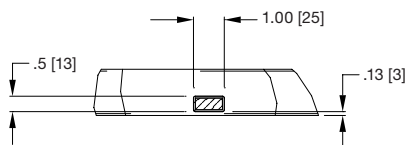

Part #	"A" Length	"B" Width	# of Rungs
CLB-6	71.00 [1803]	12.00 [305]	6
CLB-6-W18	71.00 [1803]	18.00 [457]	6
CLB-6-W24	71.00 [1803]	24.00 [610]	6
CLB-10	119.00 [3023]	12.00 [305]	10
CLB-10-W18	119.00 [3023]	18.00 [457]	10
CLB-10-W24	119.00 [3023]	24.00 [610]	10

what **great systems** are built on.™

A brand of **legrand**



**Middle Atlantic Products**

middleatlantic.com | middleatlantic.ca