

Dispenser box

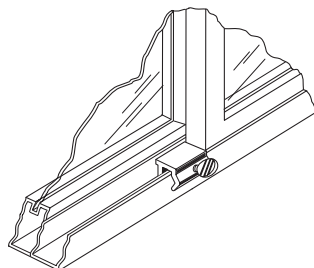

Cut-case merchandiser

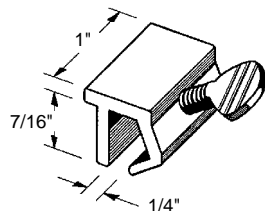
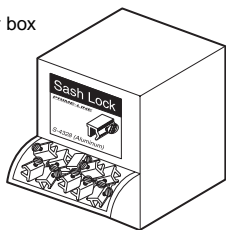
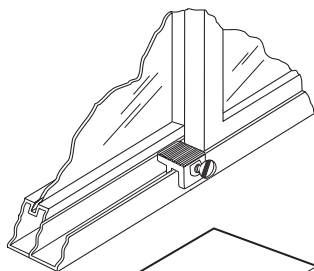
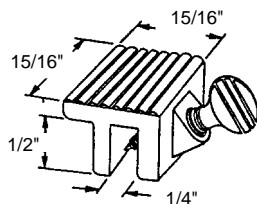
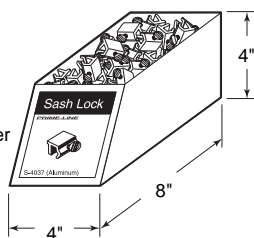

Dispenser box

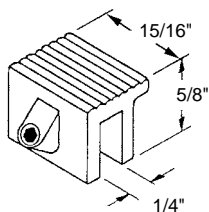
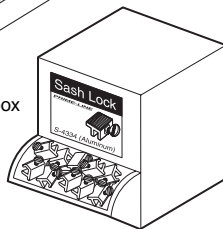

S-4032
S-4033
S-4371

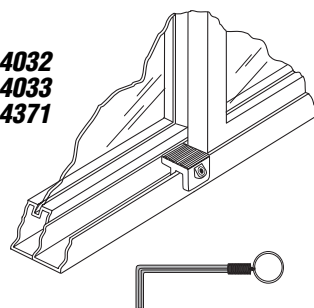

Sash Locks

Finish (Part Number)			Qty.	Qty.
Mill	Black	White	Carded	Dispenser Box
S-4036	S-4076	S-4336	2	—
S-4348	S-4458	S-4457	4	—
S-4328	S-4329	S-4367	—	200/bulk
S-4495	S-4496	S-4497	2/bag	75 bags

Description: Extruded aluminum housing; steel thumbscrew; securely locks window in closed or ventilating position; easy to install.

S-4037 (Aluminum finish)

S-4075 (Black finish)

S-4198 (White finish)

Sash Locks

Contents: 100 locks bulk in a cut-case box.

Description: Extruded aluminum housing; steel thumbscrew; securely locks window in closed or ventilating position; easy to install.

Sash Locks

Finish (Part Number)			Qty.	Qty.
Mill	Black	White	Carded	Dispenser Box
S-4000	S-4001	S-4340	2	—
S-4334	S-4335	S-4470	—	200/bulk
S-4492	S-4493	S-4494	2/bag	75 bags

Description: Heavy duty zinc diecast housing with steel thumbscrew; securely locks window in closed or ventilating position; easy to install.

S-4032 (Aluminum finish)

S-4033 (Black finish)

S-4371 (White finish)

Sash Locks (Tamper-proof)

Contents: 2 locks.

Description: Heavy duty zinc diecast housing with tamperproof Allen head security screw and wrench; securely locks window in closed or ventilating position; prevents accidental opening by children; easy to install.