

Revision	v.01	Revision date	2017-03-06
Paper size	A4	Release date	2017-03-06
Created by	NAA	Scale	1:6

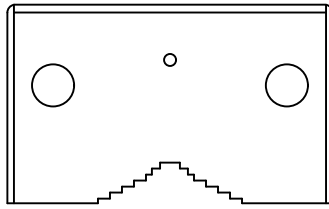

Or

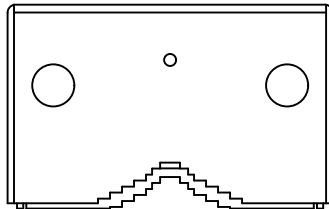

Or

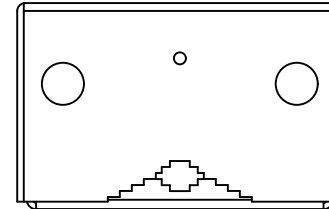

172mm [6.77"]

108mm [4.24"]

Ø8mm [Ø0.33"]

280mm [11.02"]

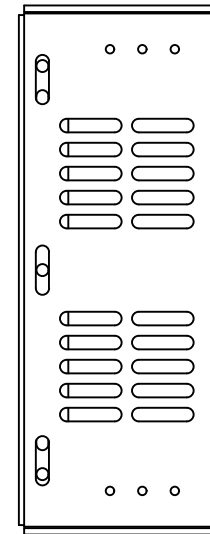
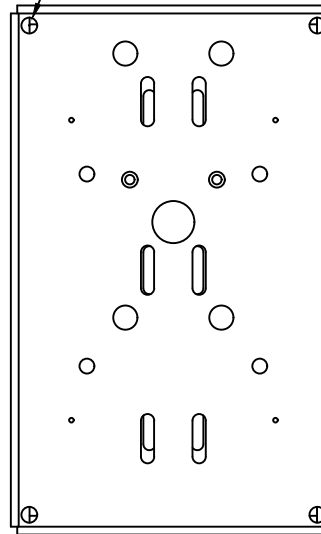
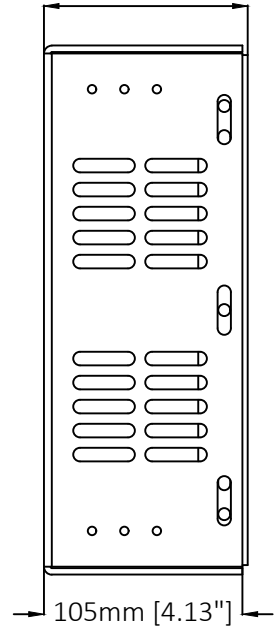
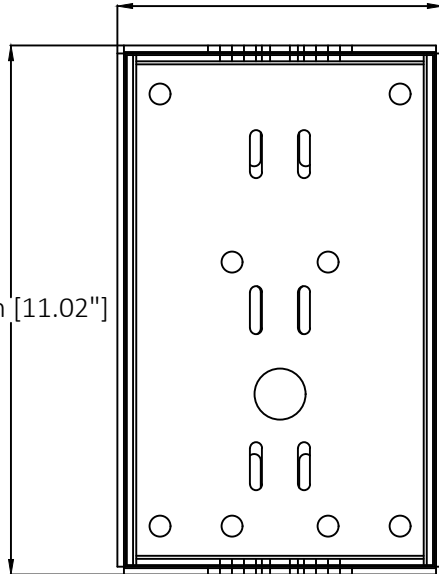

105mm [4.13"]

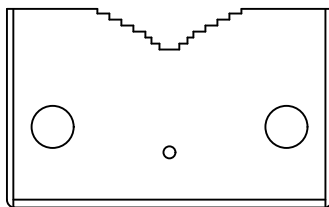

108mm [4.24"]

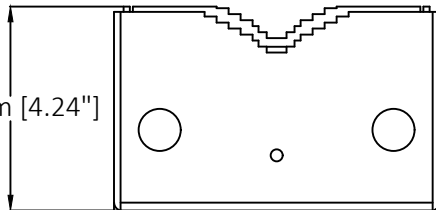

172mm [6.77"]

Or

Or

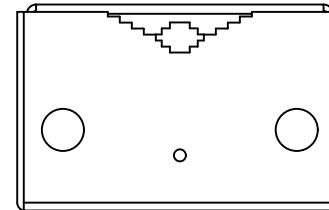

AXIS T93C Wall-Pole Conduit Back Box

Revision	v.01	Revision date	2017-03-06
Paper size	A4	Release date	2017-03-06
Created by	NAA	Scale	1:4

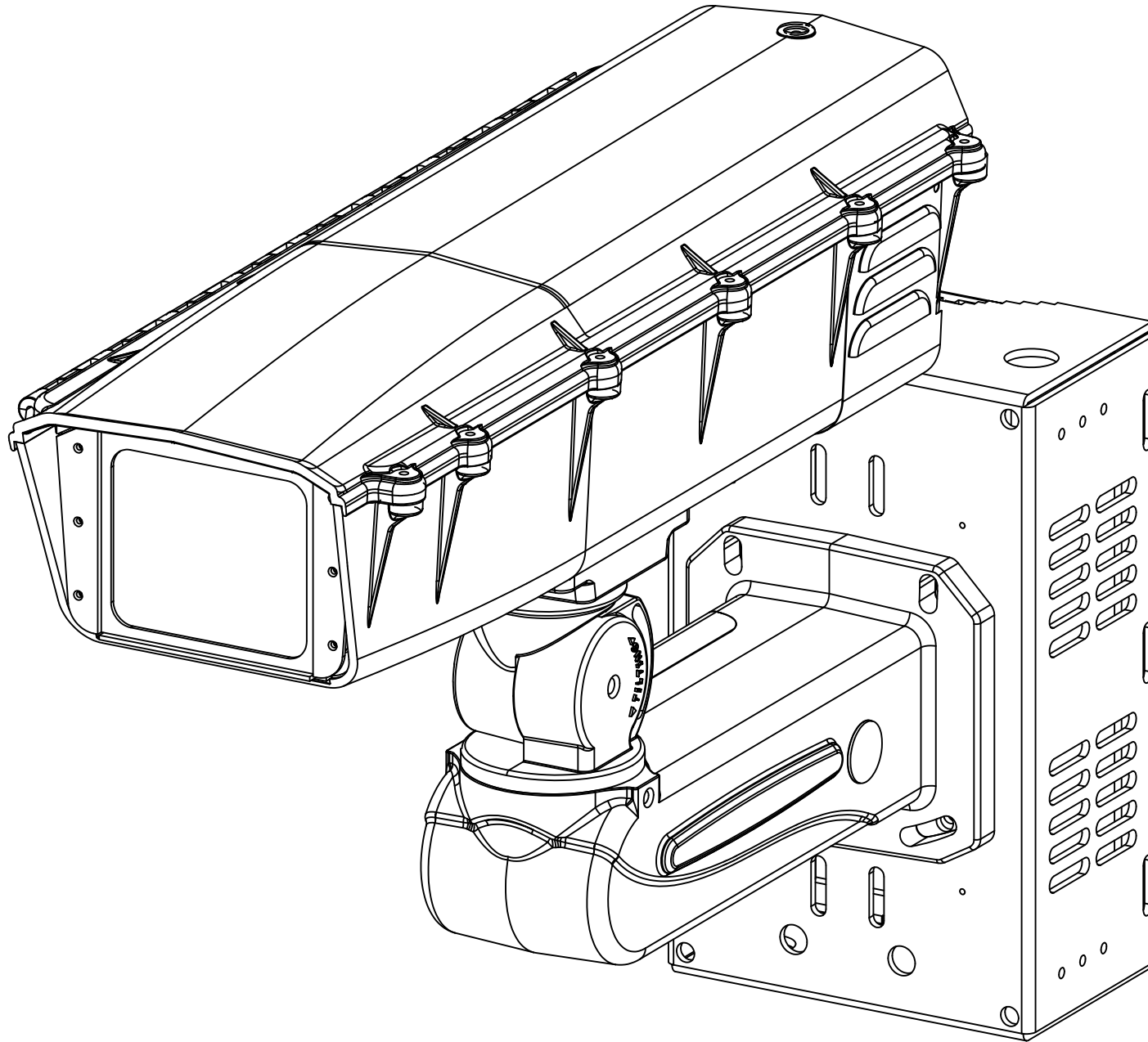

AXIS T93C Wall-Pole Conduit Back Box

Revision	v.01	Revision date	2017-03-06
Paper size	A4	Release date	2017-03-06
Created by	NAA	Scale	NA