

**PolarChoice**  
Boundary Satellite  
Multi-Pattern Wireless  
Boundary Microphone



**Key Features:**

- Selectable polar patterns; omni, cardioid, supercardioid or figure 8.
- RF shield provides superior RFI/GSM shielding.
- Consistent microphone voicing across all four (4) patterns.
- Easy to use mute switch. Can be programmed to operate as either latching on/off or momentary push-to-mute/push-to-talk.
- High visibility blue LED clearly displays mic status to the user.
- Accepts Electro-Voice & Telex bodypack transmitters. (See page 3 for details.)
- Wireless system sold separately.



**General Description:**

The PC Boundary Satellite is a low profile multi-pattern microphone. This low-profile foundation hides PC Boundary Satellite's most powerful feature—space for a wireless transmitter, and is highly shielded from RFI/GSM thanks to EV's exclusive RF shield technology. Turn the microphone over to reveal the specially designed compartment for housing an Electro-Voice or Telex bodypack transmitter. Connect the microphone to the bodypack, set-up the wireless channel, and place the PC Boundary Satellite anywhere an easy-to-use microphone is required. No longer do you have to cut holes in tables, run long cables, or compromise the architectural integrity of an installation. With the PC Boundary Satellite, anything is possible.

The PC Boundary Satellite features an EV PolarChoice multi-pattern microphone. The multi-pattern versatility of the PolarChoice microphone makes it a true "problem solver". With one non-directional and three directional polar patterns available, the PolarChoice microphone is ideal for virtually any installation. Of particular interest is the figure 8 pattern that allows miking people on opposite sides of a table with only one mic, while providing dramatic reduction of ambient room noise.

The PC Boundary Satellite is designed to take acoustic advantage of placing a microphone close to a "boundary" such as conference table. Advantages include reduced phase cancellation and up to 3 dB reduction in ambient noise.

The PC Boundary Satellite also includes a switchable high pass filter and high-performance vibration damping pads on the bottom to greatly reduce any vibration induced noise pick-up.

**Technical Specifications:**

<b>Generation Element:</b>	Dual condenser, back electret
<b>Frequency Response:</b>	50 Hz to 20,000 Hz (see chart)
<b>Polar Patterns:</b> (see chart)	Omnidirectional Cardioid Supercardioid Figure 8
<b>Switches and Controls:</b>	Top mounted momentary membrane switch Push on/off, or push-to-mute selector Power up on/off selector High-pass enable 4-position polar pattern selector
<b>Sensitivity, Open Circuit Voltage, 1 kHz:</b>	17.8 mV/Pascal
<b>Clipping Level (1% THD):</b>	>128 dB SPL
<b>Equivalent Noise:</b>	<26 dB SPL "A" weighted (0 dB = 20 micropascals) Dynamic Range: >98 dB
<b>Output Impedance, 1 kHz:</b>	1000 Ω
<b>Power Requirements:</b>	5 VDC, supplied by optional bodypack
<b>Current Consumption:</b>	<1.9 mA
<b>Polarity:</b>	Pin 2 positive, referenced to pin 1, with positive pressure on the diaphragm
<b>Dimensions (without bodypack):</b>	Length: 140.8 mm (5.5 in) Width: 81.2 mm (3.2 in) Height: 50.3 mm (2.0 in)
<b>Net Weight (without bodypack):</b>	128 grams (4.5 oz)



## PolarChoice Boundary Satellite Controls:

### Switch "A" — High-Pass Select:

Start with this switch set to the left (flat response). If the mic is in a location where low frequency rumble or wind noise is encountered, moving this switch to the right will help by reducing low frequency sensitivity.

Flat ( — ): Normal response.

High Pass ( / ): minimum 5 dB reduction in sensitivity at 100 Hz.

### Switch "B" — Polar Pattern Select:

The cardioid polar pattern works well for most installations. If feedback from a sound system occurs, switching to the supercardioid pattern will usually allow increased mic gain before feedback. The figure 8 pattern can be used to mic two people sitting on opposite sides of a table, potentially reducing the total number of mics required. The omnidirectional pattern is best suited for situations where there is no sound reinforcement system present, such as for recording.

### Switch "C" and "D":

Together control the actions of the push-button switch power-up state. NOTE: The blue light on the front of the mic is lighted whenever the microphone audio is active.

**Momentary Modes** — When switch "C" is set to the left, the pushbutton switch action will be momentary. If switch "D" is in the left hand position, the mic will be in push-to-mute mode. If switch "D" is in the right hand position, the mic will be in push-to-talk mode.

**Toggle Modes** — When switch "C" is set to the right hand position, the pushbutton switch will be in the toggle (push-on/push-off) mode. The setting of switch "D" in this case will determine if the audio is muted when the mic is initially turned on.

If switch "D" is in the left hand position, the mic audio will be muted when the mic is turned on.

If switch "D" is in the right hand position, the mic audio will be active when the mic is turned on.

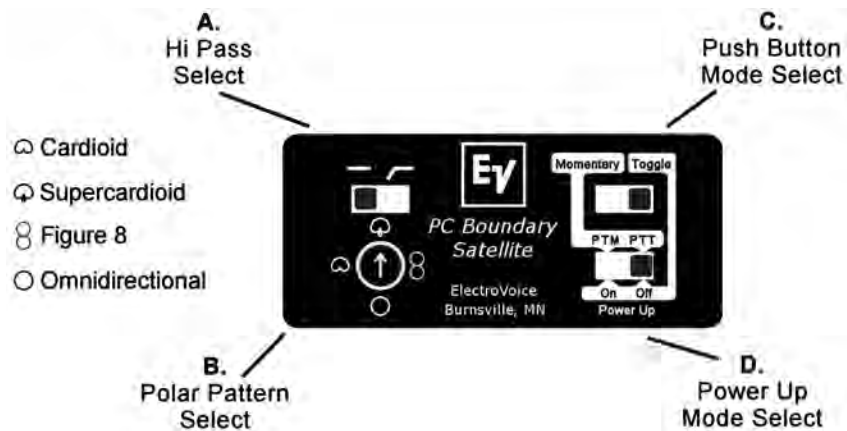

## Installing a Bodypack Transmitter:

**NOTE:** The bodypack transmitter must have the “bodypack” button installed on the back of its’ housing. The bodypack does not ship with this part attached.

1. Insert the bodypack into the PC Boundary Satellite (see figure 2). “Bodypack” button inserts into opening on the bottom plate. Push the bodypack into the plate and slide down as shown.
2. Carefully insert the TA4F connector into the bodypack (see figure 3).
3. Turn on the bodypack transmitter and check for mic level. (Make sure that the blue light on the front of the mic is on and the audio is not muted.)
4. Test the mic in an actual use situation, and set the audio gain on the bodypack transmitter for optimal gain through the wireless system.

**NOTE:** The battery door may be opened to access the gain adjustment in the bodypack without removing the bodypack from the microphone.

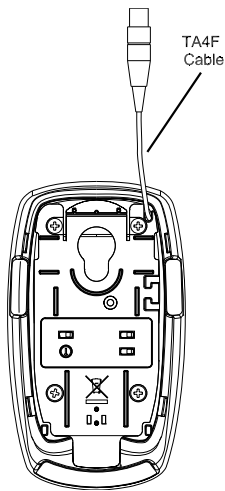

**Figure 1:**  
Bottom View

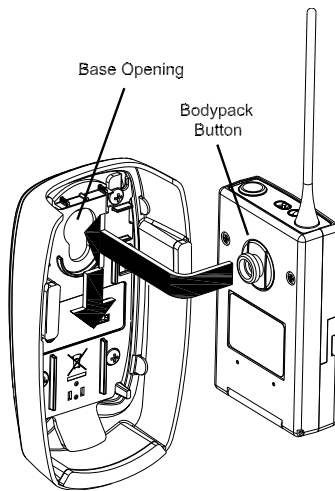

**Figure 2:**  
Installation of  
Bodypack Transmitter

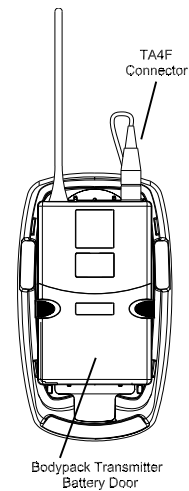

**Figure 3:**  
Bottom View with  
Bodypack Transmitter

## Applications:

The PC Boundary Sat is acoustically designed for high-quality sound reinforcement and broadcast applications. The frequency response is tailored for wide-range sound reproduction with very natural sound pick-up. The PC Boundary Sat is ideal for boardrooms, conference tables, or anywhere a high quality low-profile microphone is required. To maximize gain-before-feedback, the PolarChoice's three (3) directional polar patterns allow the user to pick the directional polar pattern for optimum effect. For those applications where gain-before-feedback is not a problem, an omnidirectional pattern is included.

## Compatible Bodypack Models:

### Electro-Voice:

REV, RE-1, RE-2

### Telex:

FMR-500, FMR-1000, SAFE-1000

## Frequency Response:

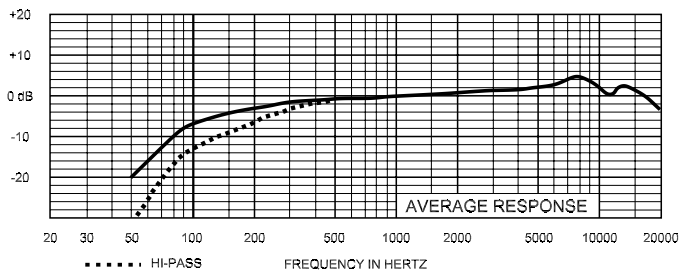

## Polar Response:

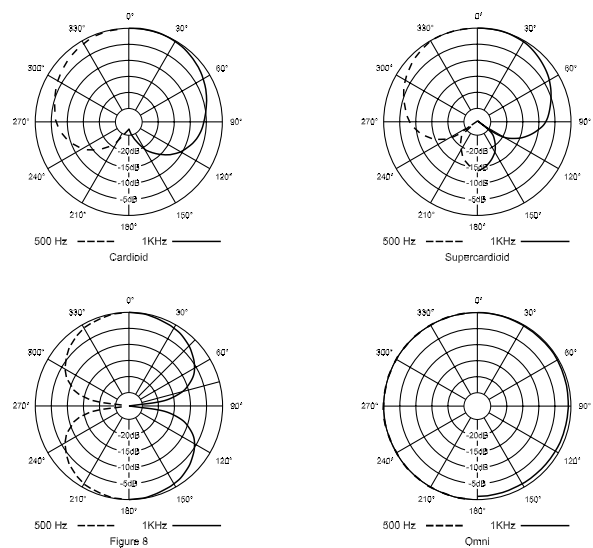

## Architects' and Engineers' Specifications:

### PC Boundary Satellite

The microphone shall be a freestanding, wireless, boundary microphone, and shall produce a high degree of output signal quality despite the possible near-field presence of RF (Radio Frequency) devices; such as cell phones. The microphone will have an integral 4-pin TA4F connector, which interfaces directly to and receives power from an Electro-Voice or Telex bodypack transmitter. The microphone shall have four (4) selectable polar patterns: omnidirectional, cardioid, supercardioid, and figure 8. The mic will contain a pair of back-electret condenser elements and the mic will have an on axis response of 50 Hz to 20 kHz. The microphone shall have an output impedance of 1000 Ohms. The microphone will have a switchable high pass filter to attenuate low frequencies. The microphone shall have an output level of 17.8 mV/Pascal, and outputs shall not be appreciably affected by the following temperature and humidity extremes: -29°C to 74°C (-20°F to 165°F) when the relative humidity is 0–50%; -29°C to 57°C (-20°F to 135°F) when the relative humidity is 0–95%. The dimensions shall be 140.8 mm (5.5 inch) long, 81.2 mm (3.2 inch) wide, and 50.3 mm (2.0 inch) high. The microphone will have a front mounted membrane switch to control the muting of the microphone audio, and an LED light to indicate when the audio is active. The operation of the membrane switch will be configurable for push on/off, push-to-talk, and push-to-mute operation. Furthermore, when the membrane switch is set for push on/off, the status of the microphone audio when power is initially applied (bodypack power turned on), can be programmed to be either on or muted. The microphone will allow access to the bodypack's controls and battery without removing the bodypack from the microphone. The Electro-Voice PC Boundary Sat microphone is specified.

## Dimension Drawing:

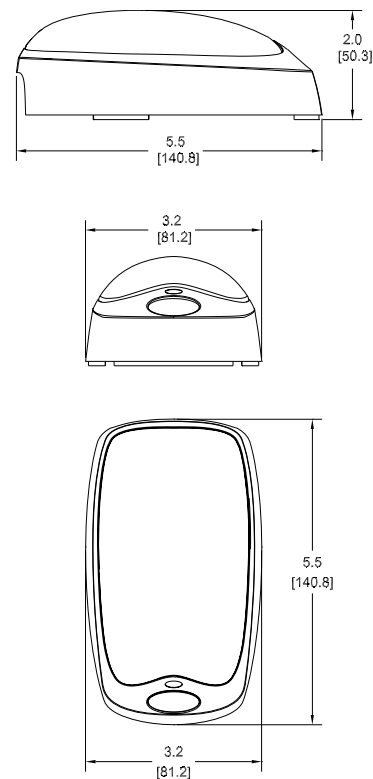

## Warranty:

Please refer to the Limited Warranty information found at: [www.electrovoice.com](http://www.electrovoice.com)

**Polar Choice Part Number:**  
PC BOUNDARY SAT - PC Boundary Satellite, Wireless Boundary

## Electro-Voice

12000 Portland Avenue South, Burnsville, MN 55337  
Phone: 952/884-4051, Fax: 952/884-0043

[www.electrovoice.com](http://www.electrovoice.com)

© Bosch Communications Systems 07/2012  
Part Number F.01U.195.895 Rev 05



U.S.A. and Canada only. For customer orders, contact Customer Service at: 800/392-3497 Fax: 800/955-6831  
Europe, Africa, and Middle East only. For customer orders, contact Customer Service at: + 49 9421-706 0 Fax: + 49 9421-706 265  
Other International locations. For customer orders, Contact Customer Service at: + 1 952 884-4051 Fax: + 1 952 887-9212  
For warranty repair or service information, contact the Service Repair department at: 800/685-2606  
For technical assistance, contact Technical Support at: 866/78AUDIO

Specifications subject to change without notice.