

EVF-1122D/126-FG

Single 12" Two-Way 120° x 60° Full-Range Fully-Weatherized Loudspeaker System



Key Features:

- Fully-weatherized fiberglass finish with gland nut and stainless-steel grille
- DH7N 3" (76 mm) diaphragm, 1.4" (36 mm) exit pure titanium compression driver
- DVX3121A 12" (305 mm) LF transducer with fully symmetric drive
- Advanced fourth-order crossover network with HF protection
- Coverage pattern: 120° x 60° Constant Directivity™ 12" rotatable waveguide
- 97 dB sensitivity, 131 dB maximum SPL
- System rating: 600 W continuous, 2400 W peak
- Active rating: LF 500 W/HF 75 W continuous (2000 W/300 W peak)
- (22) M10 threaded suspension points

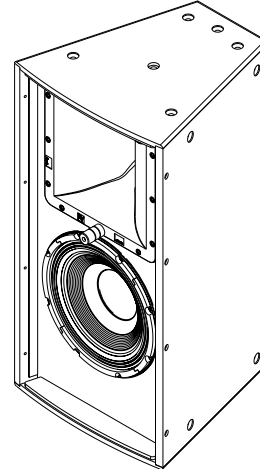

General Description:

The Electro-Voice EVF-1122D/126-FG is a fully-weatherized, fiberglass-coated, high-power, two-way loudspeaker system that can be used in a variety of applications where high-quality sound reinforcement is required in a compact, lightweight package.

The EVF-1122D/126-FG utilizes the DH7N, a high-output 3" titanium compression driver, coupled to a Constant Directivity™ 120° x 60° waveguide. The DVX3121A 12" woofer was developed using FEA optimization for motor, suspension, and electrical design to ensure very low distortion, high efficiency, and maximum intelligibility at high SPL. The crossover uses steep, 24-dB-per-octave slopes with equalization for very smooth response in the vocal range, linear off-axis response, and a protection circuit for long-term reliability.

The EVF-1122D/126-FG's features make it ideal for many fixed-install applications, including applications with full exposure to outdoor elements. The trapezoidal enclosure is constructed of weather-resistant birch, and coated with fiberglass for maximum protection from extreme outdoor elements. The unique acoustic and rigging design allows for vertical and horizontal clusters to be built using any combination of loudspeakers from the entire EVF and EVH series. With seven horn patterns to choose from, along with an assortment of low-frequency and subwoofer loudspeakers, you have the tools to maximize flexibility of system design, no matter what the application and budget. The innovative input panel provides a choice of Phoenix-style connector (included in all standard models) or the ability to add a dual NL4-type connector cover plate or gland-nut cover plate (for weatherizing applications). An externally accessible jumper selects passive or active operation. An available 70.7/100-V transformer kit may be easily mounted to the input panel for use in distributed systems. All these features give you the flexibility to address a large range of venues, quickly and precisely supporting customer requirements with fewer items in inventory.

Technical Specifications:

Freq. Response ¹ (-3 dB):	118 Hz - 18 kHz
Freq. Range ¹ (-10 dB):	66 Hz - 21 kHz
Rotatable Coverage:	120° x 60°
Rec. High-Pass Frequency:	65 Hz
Passive Crossover Freq.:	1300 Hz
Axial Sensitivity ¹ :	97 dB (1 W/1 m)
Max. Calculated SPL ¹ :	131 dB
Passive Power Handling ² :	600 W continuous, 2400 W peak
Impedance:	8 ohms (nominal), 6.0 ohms (min.)
LF Transducer - DVX3121A, 12" (305 mm) driver	
LF Axial Sensitivity ⁴ :	98 dB (1 W/1 m)
LF Max. Calculated SPL:	131 dB
LF Power Handling ³ :	500 W continuous, 2000 W peak
LF Impedance:	8 ohms (nominal), 7.2 ohms (min.)
HF Transducer - DH7N, 3" (76 mm) diaphragm compression driver	
HF Axial Sensitivity ⁴ :	110 dB (1 W/1 m)
HF Max. Calculated SPL:	135 dB
HF Power Handling ³ :	75 W continuous, 300 W peak
HF Impedance:	8 ohms (nominal), 6.0 ohms (min.)
Connectors:	Dual four-pin 10 AWG Phoenix/Euro Block screw-terminals, CDG dual-gland-nut input panel cover included for weatherizing
Enclosure:	13-ply weather-resistant birch with fiberglass finish
Grille:	18 GA stainless steel with hydrophobic cloth
Environmental:	IEC 60529 IP55
Suspension:	(22) M10 threaded suspension points
Dimensions (H x W x D):	30.26" x 16.00" x 16.27" (768.6 mm x 406.3 mm x 413.3 mm)
Weight:	65.5 lb (29.7 kg) net, 75.8 lb (34.4 kg) shipping

¹ Half-space measurement.

² EIA RS-426A, tested for eight hours.

³ AES 2-1984, tested for eight hours.

⁴ Arithmetic averages, 300 - 1,300 Hz (LF) and 1,300 - 5,000 Hz (HF).



EVF-1122D/126-FG Loudspeaker System

Frequency Response & Impedance:

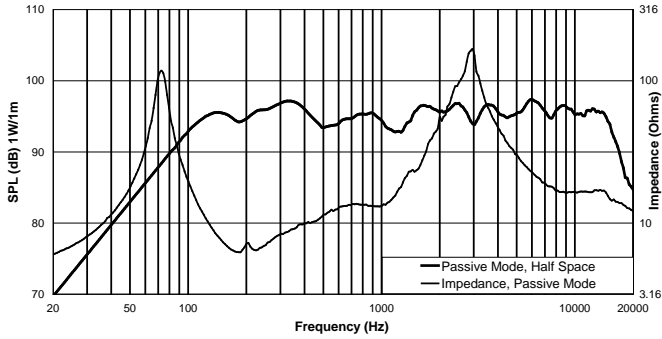

Horizontal Off-Axis Frequency Response:

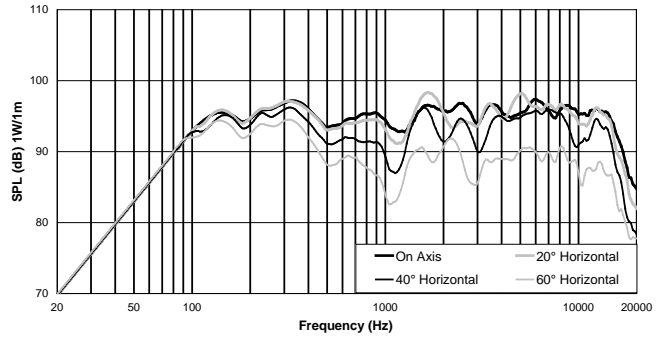

Vertical Off-Axis Frequency Response (Up):

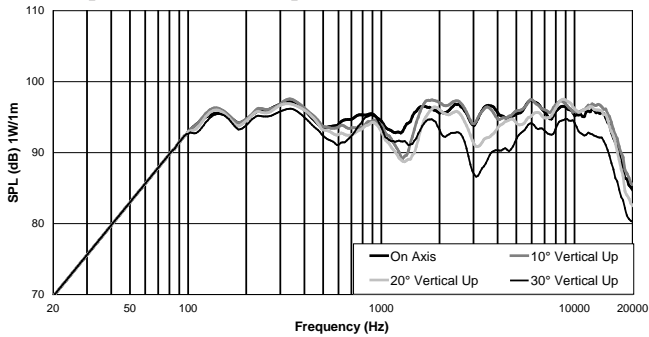

Vertical Off-Axis Frequency Response (Down):

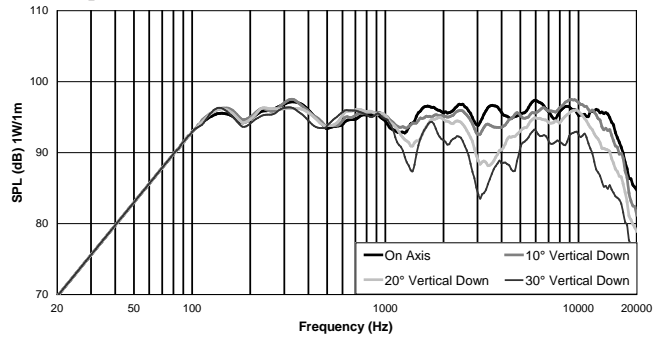

Beamwidth:

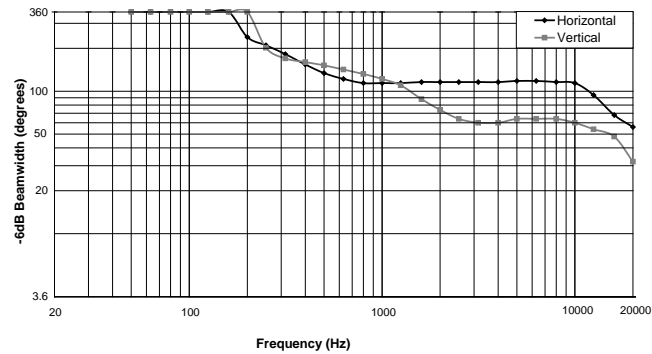

Directivity:

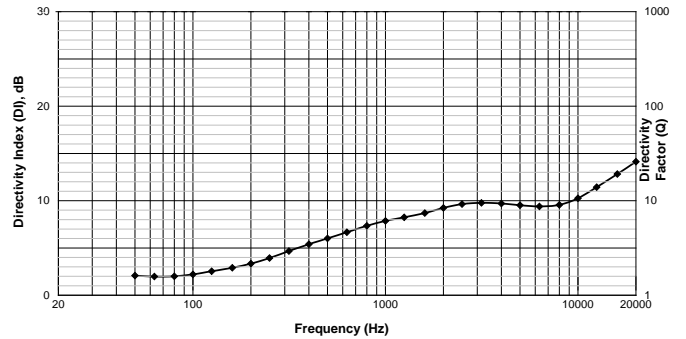

Block Diagram (biamp):

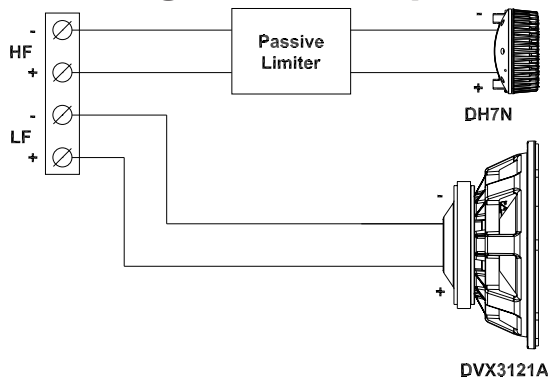

Block Diagram (passive):

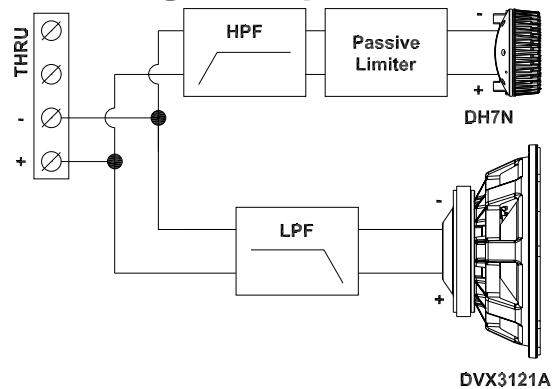

Polar Plots (1/3 Octave):

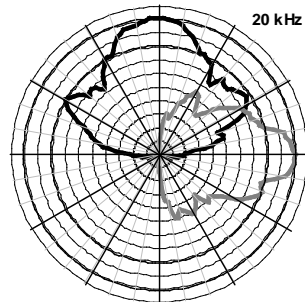
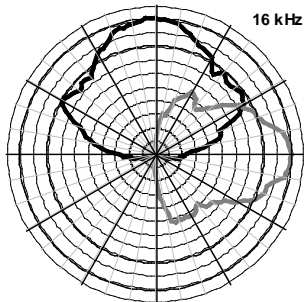
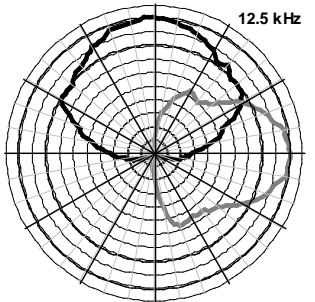
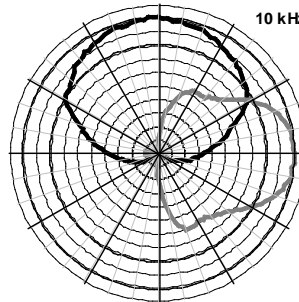
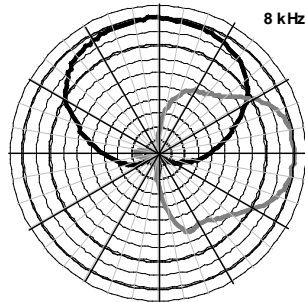
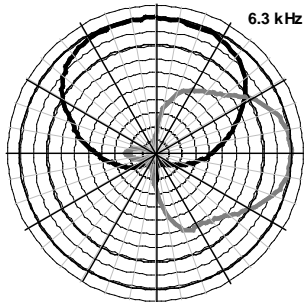
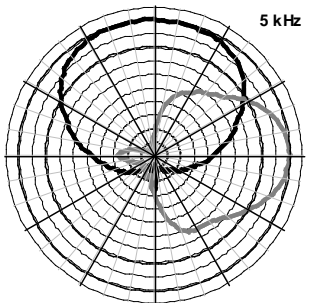
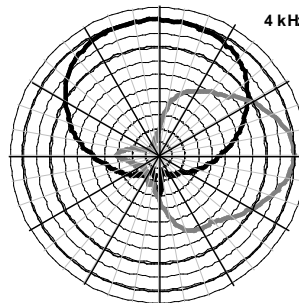
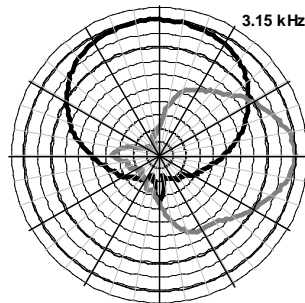
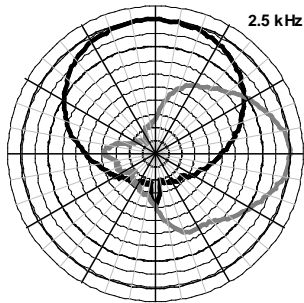
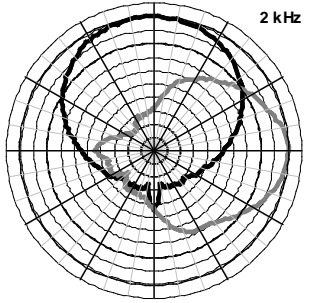
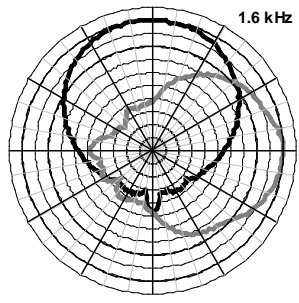
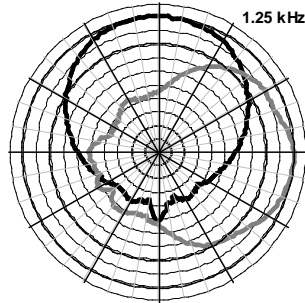
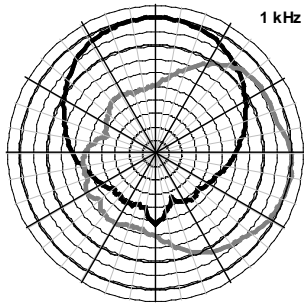
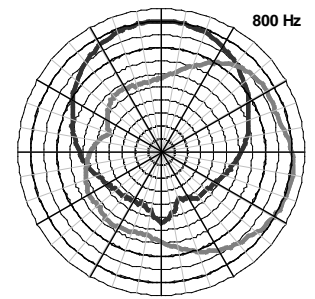
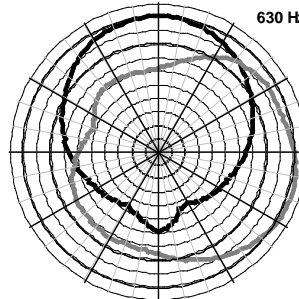
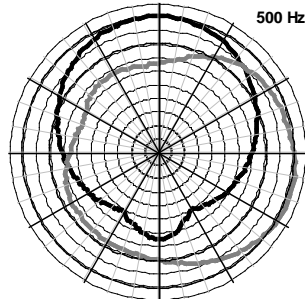
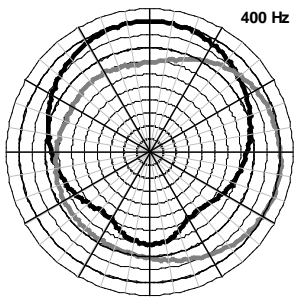

Horizontal = Black
Vertical = Grey

Dimension Drawings:

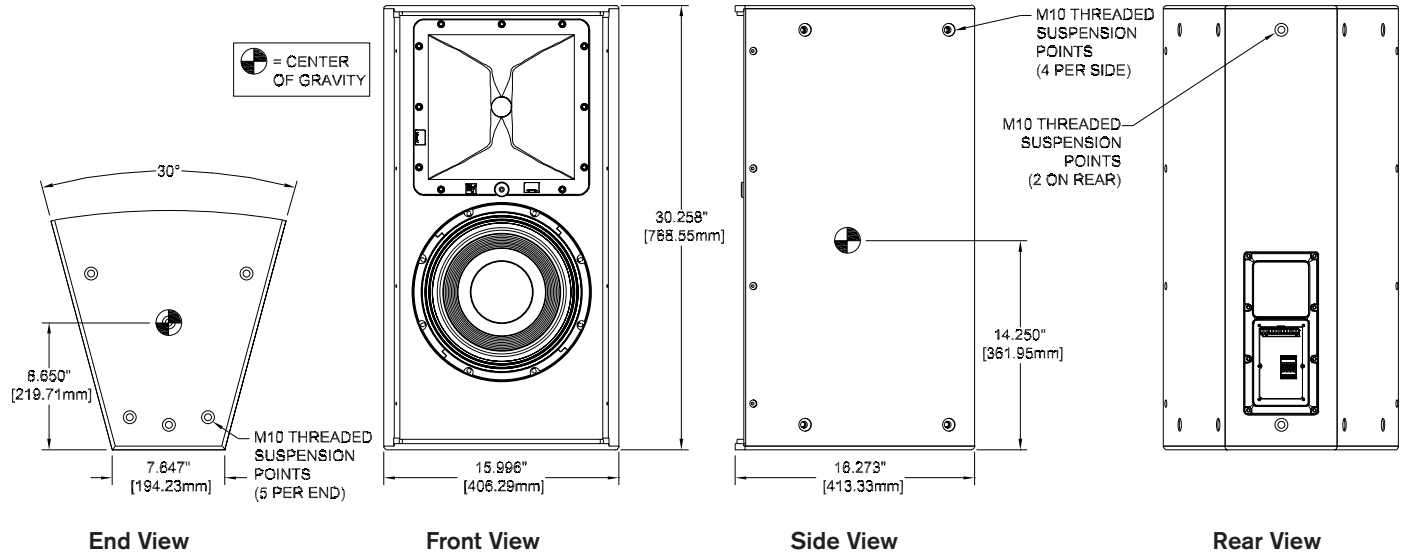

EVF-1122D/126 Product Descriptions

- EVF-1122D/126-BLK, 120° x 60°, Black Finish
- EVF-1122D/126-WHT, 120° x 60°, White Finish
- EVF-1122D/126-PIB, 120° x 60°, Black Finish, Weather Resistant
- EVF-1122D/126-PIW, 120° x 60°, White Finish, Weather Resistant
- EVF-1122D/126-FGB, 120° x 60°, Black Finish, Weather Resistant Fiberglass
- EVF-1122D/126-FGW, 120° x 60°, White Finish, Weather Resistant Fiberglass

⚠ CAUTION ⚠

This EVF loudspeaker should be suspended overhead only in accordance with the procedures and limitations specified in the *EVF/EVH User Manual* and possible manual update notices. This system should be suspended with certified rigging hardware by an authorized rigging professional and in compliance with local, state, and federal overhead suspension ordinances.

Performance Match

- EVF-1122D/64, 60° x 40° Coverage
- EVF-1122D/66, 60° x 60° Coverage
- EVF-1122D/94, 90° x 40° Coverage
- EVF-1122D/96, 90° x 60° Coverage
- EVF-1122D/99, 90° x 90° Coverage
- EVF-1152D/43, 40° x 30° Coverage
- EVF-1152D/64, 60° x 40° Coverage
- EVF-1152D/66, 60° x 60° Coverage
- EVF-1152D/94, 90° x 40° Coverage
- EVF-1152D/96, 90° x 60° Coverage
- EVF-1152D/99, 90° x 90° Coverage
- EVF-2121S, Dual 12" Bass Element
- EVF-2151D, Dual 15" Bass Element
- CPS2.9, 120V Power Amplifier, 2 x 900W
- CPS2.12, 120V Power Amplifier, 2 x 1200W
- CPS4.5, 120V Power Amplifier, 4 x 500W
- CPS4.10, 120V Power Amplifier, 4 x 1000W

Accessories

- CDNL4, Cover Plate, Dual NL4
- CSG, Cover Plate, Single Gland Nut
- CDG, Cover Plate, Dual Gland Nut
- TK-150, 70V Transformer, 150W
- HRK-1B, Horiz. Rigging Kit, EVF, Black
- HRK-1W, Horiz. Rigging Kit, EVF, White
- HRK-2B, Horiz. Rigging Kit, EVF-SUB, Black
- HRK-2W, Horiz. Rigging Kit, EVF-SUB, White
- VRK-1B, Vert. Rigging Kit, EVF, Black
- VRK-1W, Vert. Rigging Kit, EVF, White
- VRK-2B, Vert. Rigging Kit, EVF-SUB, Black
- VRK-2W, Vert. Rigging Kit, EVF-SUB, White
- EVF-UB-BLK, U-Bracket Kit, EVF, Black
- EVF-UB-WHT, U-Bracket Kit, EVF, White

Electro-Voice

12000 Portland Avenue South, Burnsville, MN 55337
Phone: 952/884-4051, Fax: 952/884-0043

www.electrovoice.com

© Bosch Communications Systems 05/2011

Part Number F.01U.196.248 Rev 02

U.S.A. and Canada only. For customer orders, contact Customer Service at:
800/392-3497 Fax: 800/955-6831

Europe, Africa, and Middle East only. For customer orders, contact Customer Service at:
+ 49 9421-706 0 Fax: + 49 9421-706 265

Other International locations. For customer orders, Contact Customer Service at:
+ 1 952 884-4051 Fax: + 1 952 887-9212

For warranty repair or service information, contact the Service Repair department at:
800/685-2606

For technical assistance, contact Technical Support at: 866/78AUDIO

Specifications subject to change without notice.