

The SBE - Encapsulated, Copper Wound Series

The SBE Encapsulated industrial control transformers are epoxy encapsulated to seal the transformer windings against moisture, dirt and industrial contaminants. Extra deep, molded terminal barriers reduce the chance of electrical failure as the result of arcing or frayed lead wires. The rugged construction and proven reliability of the SBE design is uniquely suited for all industrial environments.



Features

- 50 - 1000 VA, 50/60 Hz – suitable for worldwide applications.
- Interleaved copper windings reduce I²R losses and maximize efficiency.
- 55°C Rise, 105°C insulation system to minimize heat
- Epoxy encapsulated to protect cores and coils against moisture, dirt, and other contaminants.
- Meets or exceeds NEMA Standard ST-1 and ANSI C89.1 for load inrush capability.
- Integrally molded, flame retardant (IEC 707/ISO Class 1210) Terminal Blocks provide greater terminal contact area and improved conductivity.
- Heavy gauge steel mounting plate
- Mounting dimensions are compatible with similar control transformers.
- Secondary fuse holders (FB2X) included for 13/32 x 1½ cartridges (fuses not included).
- Factory-installed fuse holders are available (See W, WA & WB options).
- Ten year limited warranty

SBE Mounting Profiles



Mounting Dimensions

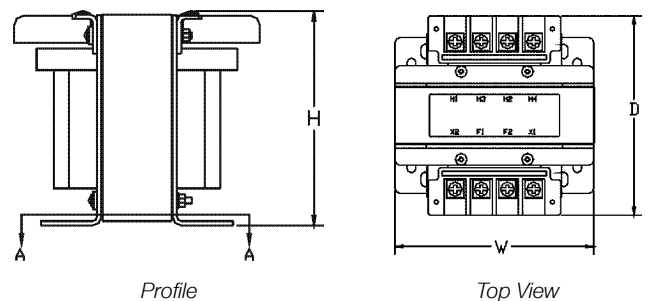

Certifications and Compliances

- Listed: E77014
 - UL 506
 - CSA C22.2 No. 66
- RoHS Compliant

Related Products

- Linear Power Supplies
- DIN Rail DC Power Supplies
- Constant Voltage Transformers
- See SBE Accessories

SBE Encapsulated Series Selection Tables

Group 1 – 120 x 240 Volt Primary, 24 Volt Secondary, 60 Hz

VA	Catalog Number	Height in (mm)	Width in (mm)	Depth in (mm)	Mtg Width W1 / W2 – in (mm)	Mtg Depth D1 / D2 – in (mm)	Slot Size S1 / S2 – in (mm)	Approx. Ship Weight lbs (kg)
50	E050E	2.72 (69.1)	3.01 (76.5)	3.99 (101.3)	2.51 / N/A (63.8 / N/A)	2.02 / N/A (51.3 / N/A)	.20 x .33 / .20 x .33 (5.1 x 8.4 / 5.1 x 8.4)	3.0 (1.36)
75	E075E	2.96 (75.2)	3.39 (86.1)	4.36 (110.7)	2.81 / 2.50 (71.4 / 63.5)	2.10 / N/A (53.3 / N/A)	.20 x .50 / .20 x .50 (5.1 x 12.7 / 5.1 x 12.7)	4.0 (1.82)
100	E100E	2.96 (75.2)	3.39 (86.1)	4.61 (117.1)	2.81 / 2.50 (71.4 / 63.5)	2.37 / N/A (60.2 / N/A)	.20 x .50 / .20 x .50 (5.1 x 12.7 / 5.1 x 12.7)	5.0 (2.27)
150	E150E	3.89 (98.8)	4.50 (114.3)	4.48 (113.8)	3.74 / 3.12 (95.0 / 79.3)	2.56 / 2.87 (65.0 / 72.9)	.20 x .65 / .20 x .33 (5.1 x 16.5 / 5.1 x 8.4)	8.0 (3.64)
200	E200E	3.89 (98.8)	4.50 (114.3)	4.79 (121.7)	3.74 / 3.12 (95.0 / 79.3)	2.87 / 3.18 (72.9 / 80.8)	.20 x .65 / .20 x .33 (5.1 x 16.5 / 5.1 x 8.4)	10.0 (4.55)
250	E250E	3.89 (98.8)	4.50 (114.3)	5.21 (132.3)	3.74 / 3.12 (95.0 / 79.3)	3.29 / 3.61 (83.6 / 91.7)	.20 x .65 / .20 x .33 (5.1 x 16.5 / 5.1 x 8.4)	11.0 (5.00)
300	E300E	4.53 (115.1)	5.25 (133.4)	4.66 (118.4)	4.38 / 3.75 (111.3 / 95.3)	3.10 / N/A (78.7 / N/A)	.31 x .71 / .31 x .71 (7.9 x 18.0 / 7.9 x 18.0)	12.0 (5.45)
350	E350E	4.53 (115.1)	5.25 (133.4)	5.07 (128.8)	4.38 / 3.75 (111.3 / 95.3)	3.54 / N/A (89.9 / N/A)	.31 x .71 / .31 x .71 (7.9 x 18.0 / 7.9 x 18.0)	15.0 (6.82)
500	E500E	4.53 (115.1)	5.25 (133.4)	5.75 (146.1)	4.38 / 3.75 (111.3 / 95.3)	4.33 / N/A (110.0 / N/A)	.31 x .85 / .31 x .85 (7.9 x 21.6 / 7.9 x 21.6)	19.0 (8.64)
750	E750E	5.56 (141.2)	6.38 (162.1)	6.93 (176.0)	5.32 / 4.37 (135.1 / 111.0)	4.25 / 5.75 (108.0 / 146.1)	.31 x .85 / .31 x .85 (7.9 x 21.6 / 7.9 x 21.6)	31.0 (14.09)



Note: Includes FB2X Secondary fuse holder.

Group 1A – Factory Installed Primary Fuse Holder Class "CC" and:

W – Secondary Fuse Holder (Midget Cartridge, 13/32" x 1 1/2" fuse) supplied, no covers

WA – Secondary Fuse Holder (Glass or Ceramic – Type 3AG, 1/4" x 1 1/4" fuse type); WB – Secondary Fuse Holder (Midget Cartridge, 13/32" x 1 1/2" fuse)

VA	Primary Fuse Holder Class "CC"			Dimensions						
	W Option – Midget Type Catalog Number	WA Option – Type 3AG w/ Covers Catalog Number	WB Option – Midget Type w/ Covers Catalog Number	Height in (mm)	Width in (mm)	Depth in (mm)	Mtg Width W1 / W2 in (mm)	Mtg Depth D1 / D2 in (mm)	Slot Size S1 / S2 in (mm)	Approx. Ship Weight lbs (kg)
50	E050EW	E050EWA	E050EWB	4.18 (106.2)	3.01 (76.5)	3.99 (101.3)	2.51 / N/A (63.8 / N/A)	2.02 / N/A (51.3 / N/A)	.20 x .33 / .20 x .33 (5.1 x 8.4 / 5.1 x 8.4)	3.0 (1.36)
75	E075EW	E075EWA	E075EWB	4.41 (112.0)	3.39 (86.1)	4.36 (110.7)	2.81 / 2.50 (71.4 / 63.5)	2.10 / N/A (53.3 / N/A)	.20 x .50 / .20 x .50 (5.1 x 12.7 / 5.1 x 12.7)	4.0 (1.82)
100	E100EW	E100EWA	E100EWB	4.41 (112.0)	3.39 (86.1)	4.61 (117.1)	2.81 / 2.50 (71.4 / 63.5)	2.37 / N/A (60.2 / N/A)	.20 x .50 / .20 x .50 (5.1 x 12.7 / 5.1 x 12.7)	5.0 (2.27)
150	E150EW	E150EWA	E150EWB	5.36 (136.1)	4.50 (114.3)	4.48 (113.8)	3.74 / 3.12 (95.0 / 79.3)	2.56 / 2.87 (65.0 / 72.9)	.20 x .65 / .20 x .33 (5.1 x 16.5 / 5.1 x 8.4)	8.0 (3.64)
200	E200EW	E200EWA	E200EWB	5.36 (136.1)	4.50 (114.3)	4.79 (121.7)	3.74 / 3.12 (95.0 / 79.3)	2.87 / 3.18 (72.9 / 80.8)	.20 x .65 / .20 x .33 (5.1 x 16.5 / 5.1 x 8.4)	10.0 (4.55)
250	E250EW	E250EWA	E250EWB	5.36 (136.1)	4.50 (114.3)	5.21 (132.3)	3.74 / 3.12 (95.0 / 79.3)	3.29 / 3.61 (83.6 / 91.7)	.20 x .65 / .20 x .33 (5.1 x 16.5 / 5.1 x 8.4)	11.0 (5.00)
300	E300EW	E300EWA	E300EWB	5.99 (152.1)	5.25 (133.4)	4.66 (118.4)	4.38 / 3.75 (111.3 / 95.3)	3.10 / N/A (78.7 / N/A)	.31 x .71 / .31 x .71 (7.9 x 18.0 / 7.9 x 18.0)	12.0 (5.45)
350	E350EW	E350EWA	E350EWB	5.99 (152.1)	5.25 (133.4)	5.07 (128.8)	4.38 / 3.75 (111.3 / 95.3)	3.54 / N/A (89.9 / N/A)	.31 x .71 / .31 x .71 (7.9 x 18.0 / 7.9 x 18.0)	15.0 (6.82)
500	E500EW	NA	E500EWB	5.99 (152.1)	5.25 (133.4)	5.75 (146.1)	4.38 / 3.75 (111.3 / 95.3)	4.33 / N/A (110.0 / N/A)	.31 x .85 / .31 x .85 (7.9 x 21.6 / 7.9 x 21.6)	19.0 (8.64)
750	E750EW	NA	E750EWB	7.01 (178.1)	6.38 (162.1)	6.93 (176.0)	5.32 / 4.37 (135.1 / 111.0)	4.25 / 5.75 (108.0 / 146.1)	.31 x .85 / .31 x .85 (7.9 x 21.6 / 7.9 x 21.6)	31.0 (14.09)

Notes: WA and WB suffix include finger safe covers. Fuses not included. FB2 sold separately for W option. Secondary fusing assembly required.

SBE Encapsulated Series Selection Tables

Group 2 – 220 x 440 Volt Primary, 110 Volt Secondary, 50/60 Hz, 230 x 460 Volt Primary, 115 Volt Secondary, 50/60 Hz
240 x 480 Volt Primary, 120 Volt Secondary, 60 Hz

VA	Catalog Number	Height in (mm)	Width in (mm)	Depth in (mm)	Mtg Width		Mtg Depth		Slot Size		Approx. Ship Weight lbs (kg)
					W1 / W2 – in (mm)	D1 / D2 – in (mm)	S1 / S2 – in (mm)				
50	E050	2.72 (69.1)	3.01 (76.5)	3.99 (101.3)	2.51 / N/A (63.8 / N/A)	2.02 / N/A (51.3 / N/A)	.20 x .33 / .20 x .33 (5.1 x 8.4 / 5.1 x 8.4)				3.0 (1.36)
75	E075	2.96 (75.2)	3.39 (86.1)	4.36 (110.7)	2.81 / 2.50 (71.4 / 63.5)	2.10 / N/A (53.3 / N/A)	.20 x .50 / .20 x .50 (5.1 x 12.7 / 5.1 x 12.7)				4.0 (1.82)
100	E100	2.96 (75.2)	3.39 (86.1)	4.61 (117.1)	2.81 / 2.50 (71.4 / 63.5)	2.37 / N/A (60.2 / N/A)	.20 x .50 / .20 x .50 (5.1 x 12.7 / 5.1 x 12.7)				5.0 (2.27)
150	E150	3.89 (98.8)	4.50 (114.3)	4.48 (113.8)	3.74 / 3.12 (95.0 / 79.3)	2.56 / 2.87 (65.0 / 72.9)	.20 x .65 / .20 x .33 (5.1 x 16.5 / 5.1 x 8.4)				8.0 (3.64)
200	E200	3.89 (98.8)	4.50 (114.3)	4.79 (121.7)	3.74 / 3.12 (95.0 / 79.3)	2.87 / 3.18 (72.9 / 80.8)	.20 x .65 / .20 x .33 (5.1 x 16.5 / 5.1 x 8.4)				10.0 (4.55)
250	E250	3.89 (98.8)	4.50 (114.3)	5.21 (132.3)	3.74 / 3.12 (95.0 / 79.3)	3.29 / 3.61 (83.6 / 91.7)	.20 x .65 / .20 x .33 (5.1 x 16.5 / 5.1 x 8.4)				11.0 (5.00)
300	E300	4.53 (115.1)	5.25 (133.4)	4.66 (118.4)	4.38 / 3.75 (111.3 / 95.3)	3.10 / N/A (78.7 / N/A)	.31 x .71 / .31 x .71 (7.9 x 18.0 / 7.9 x 18.0)				12.0 (5.45)
350	E350	4.53 (115.1)	5.25 (133.4)	5.07 (128.8)	4.38 / 3.75 (111.3 / 95.3)	3.54 / N/A (89.9 / N/A)	.31 x .71 / .31 x .71 (7.9 x 18.0 / 7.9 x 18.0)				15.0 (6.82)
500	E500	4.53 (115.1)	5.25 (133.4)	5.75 (146.1)	4.38 / 3.75 (111.3 / 95.3)	4.33 / N/A (110.0 / N/A)	.31 x .85 / .31 x .85 (7.9 x 21.6 / 7.9 x 21.6)				19.0 (8.64)
750	E750	5.56 (141.2)	6.38 (162.1)	6.93 (176.0)	5.32 / 4.37 (135.1 / 111.0)	4.25 / 5.75 (108.0 / 146.1)	31 x .85 / .31 x .85 (7.9 x 21.6 / 7.9 x 21.6)				31.0 (14.09)
1000	E1000	5.56 (141.2)	6.38 (162.1)	7.36 (186.9)	5.32 / 4.37 (135.1 / 111.0)	4.68 / 6.18 (118.9 / 157.0)	31 x .85 / .31 x .85 (7.9 x 21.6 / 7.9 x 21.6)				36.0 (16.36)



Note: Includes FB2X Secondary fuse holder.

Group 2A – Factory Installed Primary Fuse Holder Class "CC" and: W – Secondary Fuse Holder (Midget Cartridge, 13/32" x 1 1/2" fuse) supplied, no covers; WA – Secondary Fuse Holder (Glass or Ceramic – Type 3AG, 1/4" x 1 1/4" fuse type); WB – Secondary Fuse Holder (Midget Cartridge, 13/32" x 1 1/2" fuse)

VA	Primary Fuse Holder Class "CC"			Dimensions						
	W Option – Midget Type Catalog Number	WA Option – Type 3AG w/ Covers Catalog Number	WB Option – Midget Type w/ Covers Catalog Number	Height in (mm)	Width in (mm)	Depth in (mm)	Mtg Width W1 / W2 in (mm)	Mtg Depth D1 / D2 in (mm)	Slot Size S1 / S2 in (mm)	Approx. Ship Weight lbs (kg)
50	E050W	E050WA	E050WB	4.18 (106.2)	3.01 (76.5)	3.99 (101.3)	2.51 / N/A (63.8 / N/A)	2.02 / N/A (51.3 / N/A)	.20 x .33 / .20 x .33 (5.1 x 8.4 / 5.1 x 8.4)	3.0 (1.36)
75	E075W	E075WA	E075WB	4.41 (112.0)	3.39 (86.1)	4.36 (110.7)	2.81 / 2.50 (71.4 / 63.5)	2.10 / N/A (53.3 / N/A)	.20 x .50 / .20 x .50 (5.1 x 12.7 / 5.1 x 12.7)	4.0 (1.82)
100	E100W	E100WA	E100WB	4.41 (112.0)	3.39 (86.1)	4.61 (117.1)	2.81 / 2.50 (71.4 / 63.5)	2.37 / N/A (60.2 / N/A)	.20 x .50 / .20 x .50 (5.1 x 12.7 / 5.1 x 12.7)	5.0 (2.27)
150	E150W	E150WA	E150WB	5.36 (136.1)	4.50 (114.3)	4.48 (113.8)	3.74 / 3.12 (95.0 / 79.3)	2.56 / 2.87 (65.0 / 72.9)	.20 x .65 / .20 x .33 (5.1 x 16.5 / 5.1 x 8.4)	8.0 (3.64)
200	E200W	E200WA	E200WB	5.36 (136.1)	4.50 (114.3)	4.79 (121.7)	3.74 / 3.12 (95.0 / 79.3)	2.87 / 3.18 (72.9 / 80.8)	.20 x .65 / .20 x .33 (5.1 x 16.5 / 5.1 x 8.4)	10.0 (4.55)
250	E250W	E250WA	E250WB	5.36 (136.1)	4.50 (114.3)	5.21 (132.3)	3.74 / 3.12 (95.0 / 79.3)	3.29 / 3.61 (83.6 / 91.7)	.20 x .65 / .20 x .33 (5.1 x 16.5 / 5.1 x 8.4)	11.0 (5.00)
300	E300W	E300WA	E300WB	5.99 (152.1)	5.25 (133.4)	4.66 (118.4)	4.38 / 3.75 (111.3 / 95.3)	3.10 / N/A (78.7 / N/A)	.31 x .71 / .31 x .71 (7.9 x 18.0 / 7.9 x 18.0)	12.0 (5.45)
350	E350W	E350WA	E350WB	5.99 (152.1)	5.25 (133.4)	5.07 (128.8)	4.38 / 3.75 (111.3 / 95.3)	3.54 / N/A (89.9 / N/A)	.31 x .71 / .31 x .71 (7.9 x 18.0 / 7.9 x 18.0)	15.0 (6.82)
500	E500W	E500WA	E500WB	5.99 (152.1)	5.25 (133.4)	5.75 (146.1)	4.38 / 3.75 (111.3 / 95.3)	4.33 / N/A (110.0 / N/A)	.31 x .85 / .31 x .85 (7.9 x 21.6 / 7.9 x 21.6)	19.0 (8.64)
750	E750W	E750WA	E750WB	7.01 (178.1)	6.38 (162.1)	6.93 (176.0)	5.32 / 4.37 (135.1 / 111.0)	4.25 / 5.75 (108.0 / 146.1)	31 x .85 / .31 x .85 (7.9 x 21.6 / 7.9 x 21.6)	31.0 (14.09)
1000	E1000W	E1000WA	E1000WB	7.01 (178.1)	6.38 (162.1)	7.36 (186.9)	5.32 / 4.37 (135.1 / 111.0)	4.68 / 6.18 (118.9 / 157.0)	31 x .85 / .31 x .85 (7.9 x 21.6 / 7.9 x 21.6)	36.0 (16.36)

Notes: WA and WB suffix include finger safe covers. Fuses not included. W option for secondary fusing requires assembly (FB2 sold separately).

SBE Series Selection Tables - continued

Group 3 – 240 x 480 Volt Primary, 24 Volt Secondary, 60 Hz

VA	Catalog Number	Height in (mm)	Width in (mm)	Depth in (mm)	Mtg Width W1 / W2 in (mm)	Mtg Depth D1 / D2 in (mm)	Slot Size in (mm)	Approx. Ship Weight lbs (kg)	
50	E050D	2.72 (69.1)	3.01 (76.5)	3.99 (101.3)	2.51 / N/A (63.8 / N/A)	2.02 / N/A (51.3 / N/A)	.20 x .33 (5.1 x 8.4)	3.0 (1.36)	
100	E100D	2.96 (75.2)	3.39 (86.1)	4.61 (117.1)	2.81 / 2.50 (71.4 / 63.5)	2.37 / N/A (60.2 / N/A)	.20 x .50 (5.1 x 12.7)	5.0 (2.27)	
250	E250D	3.89 (98.8)	4.50 (114.3)	5.21 (132.3)	3.74 / 3.12 (95.0 / 79.3)	3.29 / 3.61 (83.6 / 91.7)	.20 x .65 (5.1 x 16.5)	11.0 (5.00)	
500	E500D	4.53 (115.1)	5.25 (133.4)	5.75 (146.1)	4.38 / 3.75 (111.3 / 95.3)	4.33 / N/A (110.0 / N/A)	.31 x .71 (7.9 x 18.0)	19.0 (8.64)	

Note: Includes FB2X secondary fuse holder.

Group 4 – 208/240/277 Volt Primary, 120/24 Volt Secondary, 60 Hz

VA	Catalog Number	Height in (mm)	Width in (mm)	Depth in (mm)	Mtg Width W1 / W2 in (mm)	Mtg Depth D1 / D2 in (mm)	Slot Size in (mm)	Approx. Ship Weight lbs (kg)	
50	E050JL	2.72 (69.1)	3.01 (76.5)	3.99 (101.3)	2.51 / N/A (63.8 / N/A)	2.02 / N/A (51.3 / N/A)	.20 x .33 (5.1 x 8.4)	3.0 (1.36)	
100	E100JL	2.96 (75.2)	3.39 (86.1)	4.61 (117.1)	2.81 / 2.50 (71.4 / 63.5)	2.37 / N/A (60.2 / N/A)	.20 x .50 (5.1 x 12.7)	5.0 (2.27)	
250	E250JL	3.89 (98.8)	4.50 (114.3)	5.21 (132.3)	3.74 / 3.12 (95.0 / 79.3)	3.29 / 3.61 (83.6 / 91.7)	.20 x .65 (5.1 x 16.5)	11.0 (5.00)	
500	E500JL	4.53 (115.1)	5.25 (133.4)	5.75 (146.1)	4.38 / 3.75 (111.3 / 95.3)	4.33 / N/A (110.0 / N/A)	.31 x .71 (7.9 x 18.0)	19.0 (8.64)	

Note: Will only accept one FB2 secondary fuse holder. Will not accept FB2X secondary fuse holder.

Group 5 – 208/240/480/600 Volt Primary, 120/24 Volt Secondary, 60 Hz
200/230/460/575 Volt Primary, 115/23 Volt Secondary, 60 Hz







VA	Catalog Number	Height in (mm)	Width in (mm)	Depth in (mm)	Mtg Width W1 / W2 in (mm)	Mtg Depth D1 / D2 in (mm)	Slot Size in (mm)	Approx. Ship Weight lbs (kg)	
50	E050JN	2.96 (75.2)	3.39 (86.1)	4.36 (110.7)	2.81 / 2.50 (71.4 / 63.5)	2.10 / N/A (53.3 / N/A)	.20 x .50 (5.1 x 12.7)	4.0 (1.81)	
100	E100JN	3.89 (98.8)	4.50 (114.3)	4.48 (113.8)	3.74 / 3.12 (95.0 / 79.3)	2.56 / 2.87 (65.0 / 72.9)	.20 x .65 (5.1 x 16.5)	8.0 (3.67)	
150	E150JN	3.89 (98.8)	4.50 (114.3)	5.21 (132.3)	3.74 / 3.12 (95.0 / 79.3)	3.29 / 3.61 (83.6 / 91.7)	.20 x .65 (5.1 x 16.5)	11.0 (5.00)	
250	E250JN	4.53 (115.1)	5.25 (133.4)	5.07 (128.8)	4.38 / 3.75 (111.3 / 95.3)	3.54 / N/A (89.9 / N/A)	.31 x .71 (7.9 x 18.0)	15.0 (6.82)	
500	E500JN	5.56 (141.2)	6.38 (162.1)	6.93 (176.0)	5.32 / 4.37 (135.1 / 111.0)	4.25 / 5.75 (108.0 / 146.1)	.31 x .85 (7.9 x 21.6)	30.0 (13.64)	

Note: Will only accept one FB2 secondary fuse holder. Will not accept FB2X secondary fuse holder.



SBE Accessories

FIELD INSTALLED OPTIONS	ACCESSORIES INCLUDED			FACTORY INSTALLED OPTIONS
Accessory Catalog Number	Primary Fuse (Class "CC" Rejection Type)	Secondary Fuse	IP20 Covers	Suffix Codes
FB2	—	Type 3AG	—	N/A
FB2 + FBPC1	Yes	Type 3AG	Yes	WA (i.e. E500WA)
FBPC1	Yes	Midget Type	Yes	WB (i.e. E500WB)
FB2X *	Yes	Midget Type	—	W (i.e. E500W)
FBP	Yes	Midget Type	—	N/A

* Supplied with most SBE models. Refer to the note at the bottom of the product selection tables.

CATALOG NUMBER	FIELD INSTALLED OPTIONS DESCRIPTIONS	CATALOG NUMBER	FIELD INSTALLED OPTIONS DESCRIPTIONS
FB2	 <p>Fuse Block – Secondary Side Field installed secondary fuse holder kit designed to accommodate one glass or ceramic, ¼" x 1¼" fuse.</p>	FBP	 <p>Fuse Block – Primary Side Field installed primary fuse holder kit designed to accommodate two class "CC" rejection type fuse. Finger safe covers not available.</p>
FBPC1	 <p>Fuse Block and Finger Safe Cover Kit Field installed primary fuse holder designed to accommodate two class "CC" rejection type fuses with primary and secondary. Finger safe covers kit.</p>	SBEDIN	 <p>DIN Circuit Breaker Mounting Field installed IEC fuse holder adaptor kit</p>
FB2X	 <p>Fuse Block – Secondary Side Field installed secondary fuse holder designed to accommodate one 13/32" x 1-1/2" (Midget type) cartridge fuse (included with applicable transformer purchase only).</p>	IP20	 <p>Terminal Covers (Two Covers Per Kit) Field installed primary and secondary IEC Touch Proof Cover Kit.</p>

FACTORY INSTALLED OPTIONS			
 <p>SBE Control Transformer without Covers - W Option (FB2X not installed)</p>	<table border="1"> <tr> <th>Option</th> </tr> <tr> <td>W</td> </tr> </table>	Option	W
Option			
W			

FACTORY INSTALLED OPTIONS			
 <p>SBE Control Transformer with Covers - WA & WB Option</p>	Option	Secondary Fusing	
	WA	Glass/Ceramic - Type 3AG (FB2 kit not installed)	
WB	Midget Type (FB2X installed)	