

BKX Round Junction Boxes

CSA Certification Only.

Applications

- Serve as pulling fittings.
- Provides openings for splicing.
- Connect and change direction of conduit runs.
- When used with a gasket, BKX junction boxes are weatherproof.
- BKX junction boxes are dust-ignitionproof when supplied for Class II applications. Suitable for use in grain elevators, flour mills and other environments where dust presents a hazard.

Features

- Malleable iron Unilets offer high tensile strength, ductility, corrosion resistance and impact and shock resistance.
- Copperfree aluminum Unilets are lightweight, self-oxidizing, self-renewing and offer a high corrosion resistance.
- Roomy interiors: more wiring space.
- Smooth, rounded integral bushing in each hub protects conductor insulation.
- Accurately tapped, tapered threads for tight, rigid joints and ground continuity.
- BKX Series
 - Enclosed and gasketed boxes when used with hub or blank covers provide CSA Type 4 fit.
 - Suitable for exposed or concealed installations.
 - Boss in rear of box allows for fifth entry, factory or field entries, 1/2" or 3/4".
 - Available in three inside depths: 1-1/2", 2-1/4" and 3".
 - Furnished with four tapped holes and two close-up plugs.
 - Available in gray iron and aluminum.
 - Cushion fixture hangers are enclosed and gasketed.
 - Available for Class II, Division 1 applications.
 - Can be fitted with terminal block.

Standard Materials

- BKX junction boxes and cast covers: gray iron
- BKX-A junction boxes and cast aluminum covers: copperfree (max. 4/10ths of 1%) aluminum
- BKX sheet metal covers: steel or aluminum
- Gaskets: neoprene or composition fiber

Standard Finishes

- Boxes and covers: triple-coat — (1) zinc electroplate, (2) chromate and (3) epoxy powder coat

Options

- Factory installed terminal block, add suffix **-CB** to catalog number

Certifications and Compliances

- CSA Standard: C22.2 No. 18.1
- CSA Certified: 013017

Related Products

- For explosionproof junction boxes, see Enclosures and Junction Boxes.
- For Class II Fixture Hangers, See *Lighting*.



BKX Junction Boxes.
Choice of three depths.



BKX Class II Junction Boxes with covers and gasket.









 CSA Certification Only.

BKX Round Junction Boxes

CSA Certification Only.

Fittings

FITTINGS: CONDUIT OUTLET BODIES





Description	Hub Size (Inches)	Catalog Number	
		Aluminum	Gray Iron
 <p>BKXS — 1-1/2" Inside Depth Furnished with four tapped holes and 4" centers, two tapped holes on 3-1/2" centers, four tapped conduit entries and two close-up plugs.</p> <p>Order covers as separate item.</p>	1/2	BKXS-1A	BKXS-1
	3/4	BKXS-2A	BKXS-2
	1	BKXS-3A	BKXS-3
 <p>BKXM — 2-1/4" Inside Depth Furnished with four tapped holes on 4" centers, two tapped holes on 3-1/2" centers, four tapped conduit entries and two close-up plugs.</p> <p>Order covers as separate item.</p>	1/2	BKXM-1A	BKXM-1
	3/4	BKXM-2A	BKXM-2
	1	BKXM-3A	BKXM-3
 <p>BKXD — 3" Inside Depth Furnished with four tapped holes on 4" centers, two tapped holes on 3-1/2" centers, four tapped conduit entries and two close-up plugs.</p> <p>Order covers as a separate item.</p>	1/2	BKXD-1A	BKXD-1
	3/4	BKXD-2A	BKXD-2
	1	BKXD-3A	BKXD-3
BKX Covers — Furnished with screws			
 <p>Cast</p>	Blank	CBK-A	CBK
	1/2	CBK-1A	CBK-1
	3/4	CBK-2A	CBK-2
 <p>Sheet Metal</p>	Blank	CB-A	CB
 <p>BKX Gasket Neoprene</p>		—	BKG
JB — Flexible Fixture Hangers — Furnished with gasket and screws.			
 <p>Ball Type 15° swing in all directions, supports 250 lbs./113.4 kgs.</p>	1/2	—	JBK-50-BS
	3/4	—	JBK-75-BS
 <p>Cushion Type Enclosed and gasketed — 8° swing in all directions. Cushions 40 lbs., supports 250 lbs./113.4 kgs.</p>	1/2	—	JBK-50-CS
	3/4	—	JBK-75-CS

 CSA Certification Only.

BKX Round Junction Box Assemblies

CSA Certification Only.

Class II, Division 1 and 2, Groups E, F, G
Class III
CSA Enclosure 4

Description	Hub Size (Inches)	Catalog Number	
		Aluminum	Gray Iron
 <p>BKXS – 1-1/2" Inside Depth Furnished with cover and attached gasket, four tapped openings and two close-up plugs.</p>	1/2	BKXS-1BA	BKXS-1B
	3/4	BKXS-2BA	BKXS-2B
 <p>BKXM – 2-1/4" Inside Depth Furnished with cover and attached gasket, four tapped openings and two close-up plugs.</p>	1/2	BKXM-1BA	BKXM-1B
	3/4	BKXM-2BA	BKXM-2B
	1	BKXM-3BA	BKXM-3B
 <p>BKXD – 3" Inside Depth Furnished with cover and attached gasket, four tapped openings and two close-up plugs.</p>	1/2	BKXD-1BA	BKXD-1B
	3/4	BKXD-2BA	BKXD-2B
	1	BKXD-3BA	BKXD-3B
 <p>BKX – Class II replacement cover assemblies Cast cover with permanently affixed gasket. Furnished with screws.</p>	—	CBK-GA	CBK-G
 <p>Terminal Block Furnished with fastening hardware. 5 wire, 20 Amp, 300 Volt.</p>	—	—	CB205B

Fittings

FITTINGS: CONDUIT OUTLET BODIES

 CSA Certification Only.

BKX Cast Junction Boxes Dimensions

CSA Certification Only.

BKX Round Base Unilet (Dimensions in Inches/Millimeters)

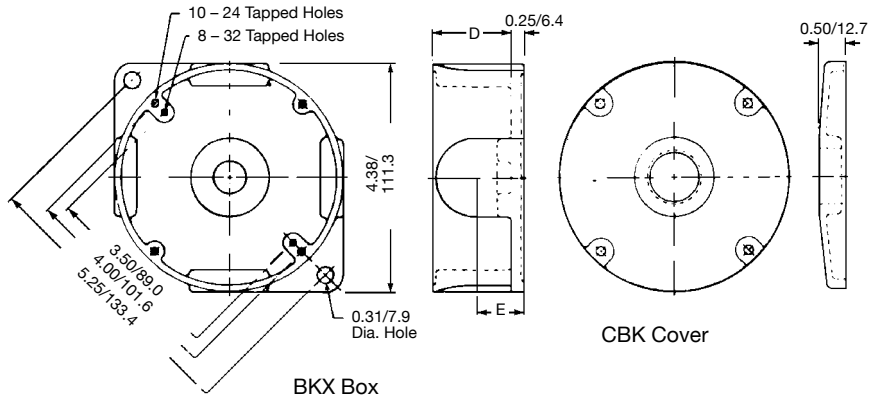

BKX Round Base Unilet for Class II (Dimensions in Inches/Millimeters)

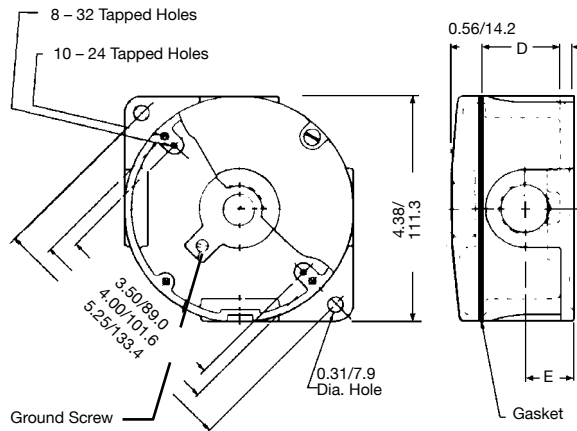

Fittings

FITTINGS: CONDUIT OUTLET BODIES

Enclosure	Dimensions in Inches/Millimeters	
	D	E
BKXS	1.50/38.1	0.94/23.9
BKXM	2.25/57.2	1.56/39.6
BKXD	3.00/76.2	1.56/39.6

 CSA Certification Only.