

SPECTRACOOL™ HAZARDOUS LOCATION INDOOR/OUTDOOR

NHZ43
11000 BTU/Hr.
3223 Watt

NHZ36
6000/8000 BTU/Hr.
1758/2344 Watt

NHZ28
4000 BTU/Hr.
1172 Watt

FEATURES

- Engineered specifically for hazardous location cooling. Not re-built from light industrial air conditioners
- Attractive design with no heavy cast enclosure and minimal use of visible fasteners
- Does not require purge and pressurized system
- Corrosion resistant coating on ambient side components for Type 4X models
- Corrosion resistant coating on ambient and enclosure side components for Type 4X Offshore models
- Dust resistant coils for filterless operation in most environments
- Cleanable, reusable aluminum mesh filter protects coils for extremely dusty and dirty atmospheres
- Digital temperature control
- Narrow design to accommodate 12-in (300-mm) deep cabinets
- R134a earth-friendly refrigerants
- Models for 115, 230 and 400/460 3-phase VAC power input
- UL Listed to save customers time and money with agency approvals
- Easy-Mount flanges for simple installation
- Mounting hardware, gaskets and user manual furnished with the unit
- Every unit functionally tested before shipping
- Standard Type 4/4X models include:
 - Active condensate management with heater strip
 - Compressor Heater
 - Head Pressure Control
 - Power-off relay for door switch and other system requirements
 - Malfunction switch

SPECIFICATIONS

- Nominal cooling capacities:
 - NHZ28 4000 BTU/hr. (1172 W)
 - NHZ36 6000 & 8000 BTU/hr. (1758 and 2344 W)
 - NHZ43 11000 BTU/hr. (3223 W)
- Outdoor model operating temperature range from -40 F/ -40 C to 131 F/ 55 C (125 F/52 C on NHZ28 Series and NHZ43 Series 115V)

FINISH

- Type 4 models RAL 7035 light-gray, semi-textured powder-coat paint
- Type 4X and Offshore models Stainless Steel 316L

NOTES

Visit www.PentairProtect.com to download 2D and 3D CAD drawings into the overall design of your electronic system.

INDUSTRY STANDARDS

UL/cUL Listed; Type 4; 4X; File No. E469720

CE
Class 1 Div 2 Groups A, B, C, D T4A

APPLICATION

- Onshore and Offshore Oil and Gas
- Chemical and petrochemical
- Mining
- Pharmaceutical
- Any location with potentially hazardous atmospheres created by vapor

Performance Data **NHZ28 4000 BTU/Hr. (1172 Watt)**

CATALOG NUMBER			
Painted Galvanized Steel Type 4	NHZ280416G300	NHZ280426G300	NHZ280446G300
Painted Galvanized Steel Type 4 with Remote Access Control*	NHZ280416G360	NHZ280426G360	NHZ280446G360
Stainless Steel Type 4X	NHZ280416G400	NHZ280426G400	NHZ280446G400
Stainless Steel Type 4X with Remote Access Control*	NHZ280416G460	NHZ280426G460	NHZ280446G460
Stainless Steel Type 4X Offshore	NHZ280416G500	NHZ280426G500	NHZ280446G500
COOLING PERFORMANCE			
Nominal:			
BTUs/Hr.	3800 / 4000	3800 / 4000	4000
Watts	1114 / 1172	1114 / 1172	1172
At 125 F / 125 F (52 C / 52 C):			
BTU/Hr. [50 / 60 Hz]	3940 / 4104	4269 / 4703	4703
Watts [50 / 60 Hz]	1150 / 1000	1250 / 1378	1378
At 95 F / 95 F (35 C / 35 C):			
BTU/Hr. [50 / 60 Hz]	3754 / 4011	3700 / 4291	4291
Watts [50 / 60 Hz]	1100 / 1175	1086 / 1257	1257
Refrigerant	R134a	R134a	R134a
Refrigerant Charge (ounces/grams)	10 / 283	11 / 312	11 / 312
Operating Temperature Range:			
Maximum (°F / °C)	125/52	125/52	125/52
Minimum (°F / °C)	-40 / -40	-40 / -40	-40 / -40
Air Flow at 0 Static Pressure:			
Internal loop 50 Hz (CFM / M ³ /Hr)	138 / 234	N/A	N/A
External loop 50 Hz (CFM / M ³ /Hr)	268 / 455	N/A	N/A
Internal loop 60 Hz (CFM / M ³ /Hr)	143 / 362	143 / 243	143 / 243
External loop 60 Hz (CFM / M ³ /Hr)	288 / 728	288 / 489	288 / 489
ELECTRICAL DATA			
Rated Voltage	110 / 115	230	460
Frequency (Hz)	50 / 60	50 / 60	50 / 60
Operating Range	+/-10%	+/-10%	+/-10%
Max. Power Consumption (Watts at 50 / 60 Hz)	930 / 1001	972 / 1106	972 / 1106
Max. Nominal Current (Amps at 50 / 60 Hz)	10.2 / 9.4	4.9 / 5.0	2.4 / 2.5
Starting Current (Amps)	40	24.5	12.5
Agency Approvals		cUL Listed CE Others available upon request	Terminal Block
Power Input Description			Terminal Block
ENCLOSURE PROTECTION			
UL Type		Type 4, 4X Standard	
CONTROLLER			
Description		Digital Controller	
Controller Location		Enclosure Side	
Factory Controller Setting (°F / °C)		80 / 27	
SOUND LEVEL			
At 1.5 Meters	66.1 dBA	65.5 dBA	65.5 dBA
UNIT CONSTRUCTION			
Material		Galvanized Sheet Metal Type 4 Models Stainless steel 316L Type 4X and Offshore Models	
Finish		RAL 7035 light-gray, semi-textured powder-coat paint standard Other colors available	
UNIT DIMENSIONS			
Height (in / mm)		28 / 711.2	
Width (in / mm)		11.50 / 292.1	
Depth (in / mm)		14.00 / 355.6	
Weight (lb / kg)	84/38	84/38	98/44

*Units with Remote Access Control utilize a digital controller and communicate via EtherNet/IP, Profinet, Modbus TCP/IP and SNMP over ethernet or modbus RTU over USB.

Performance Curves for NHZ28 Models 4000 BTU/Hr. (1172 Watt)

NHZ28-0416-GXXX Capacity Curves at 50 Hz
Ambient Air In (°C)

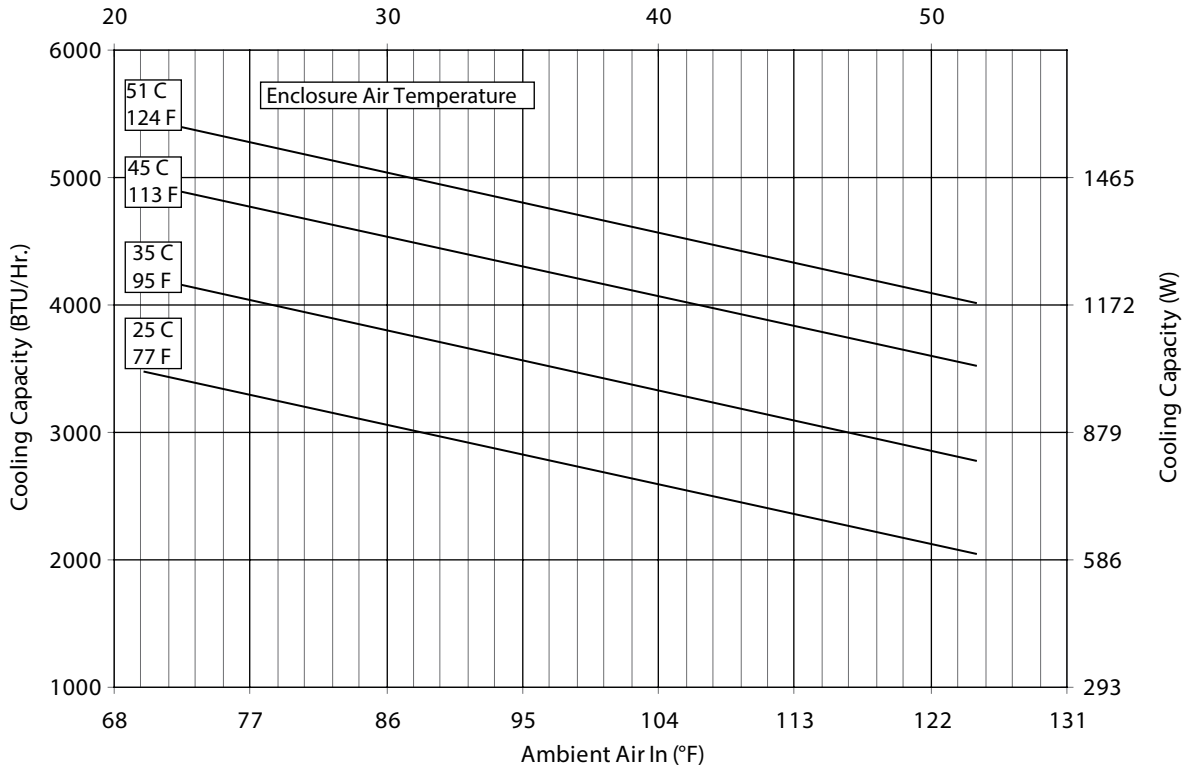

NHZ28-0416-GXXX Capacity Curves at 60 Hz
Ambient Air In (°C)

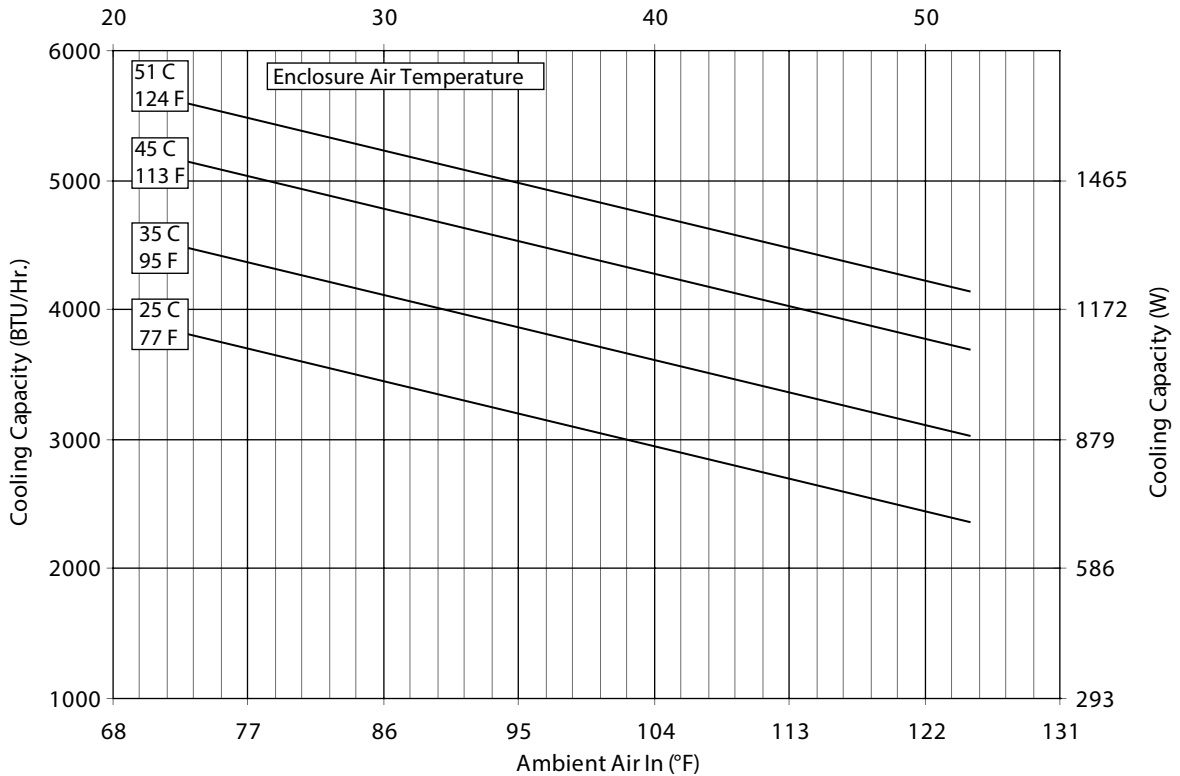

Performance Curves for NHZ28 Models 4000 BTU/Hr. (1172 Watt)

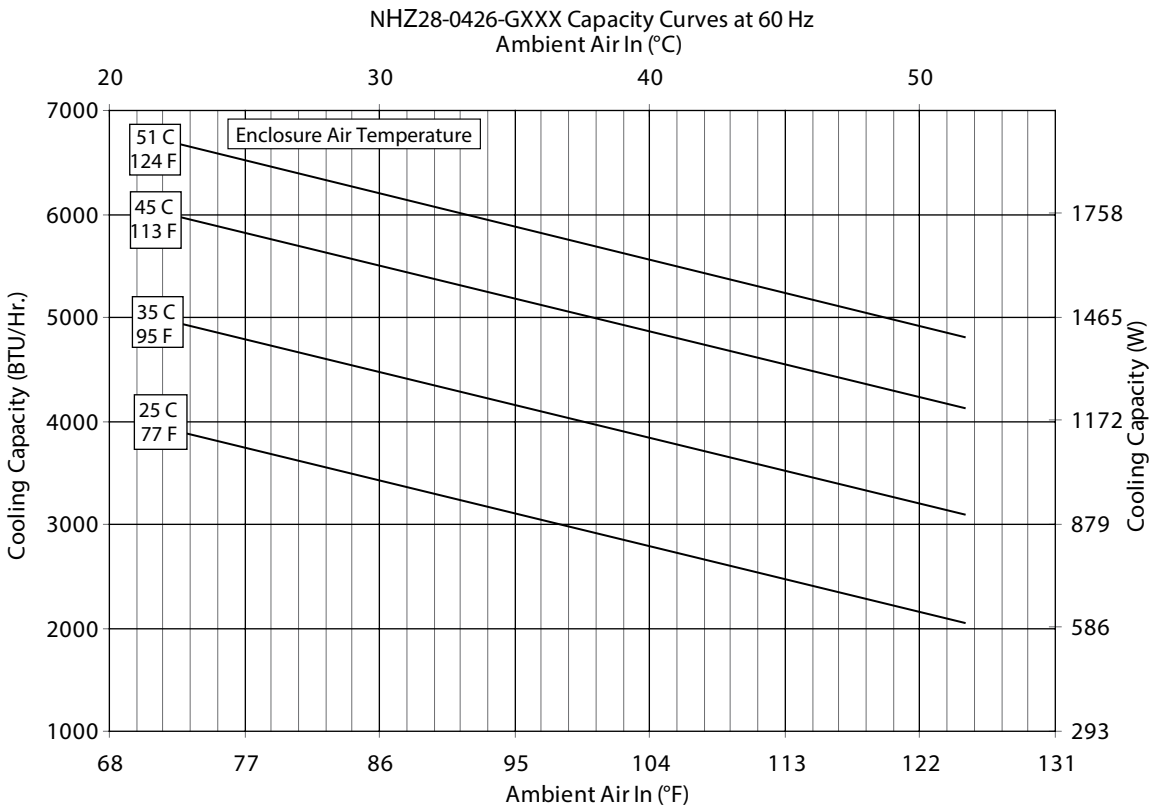
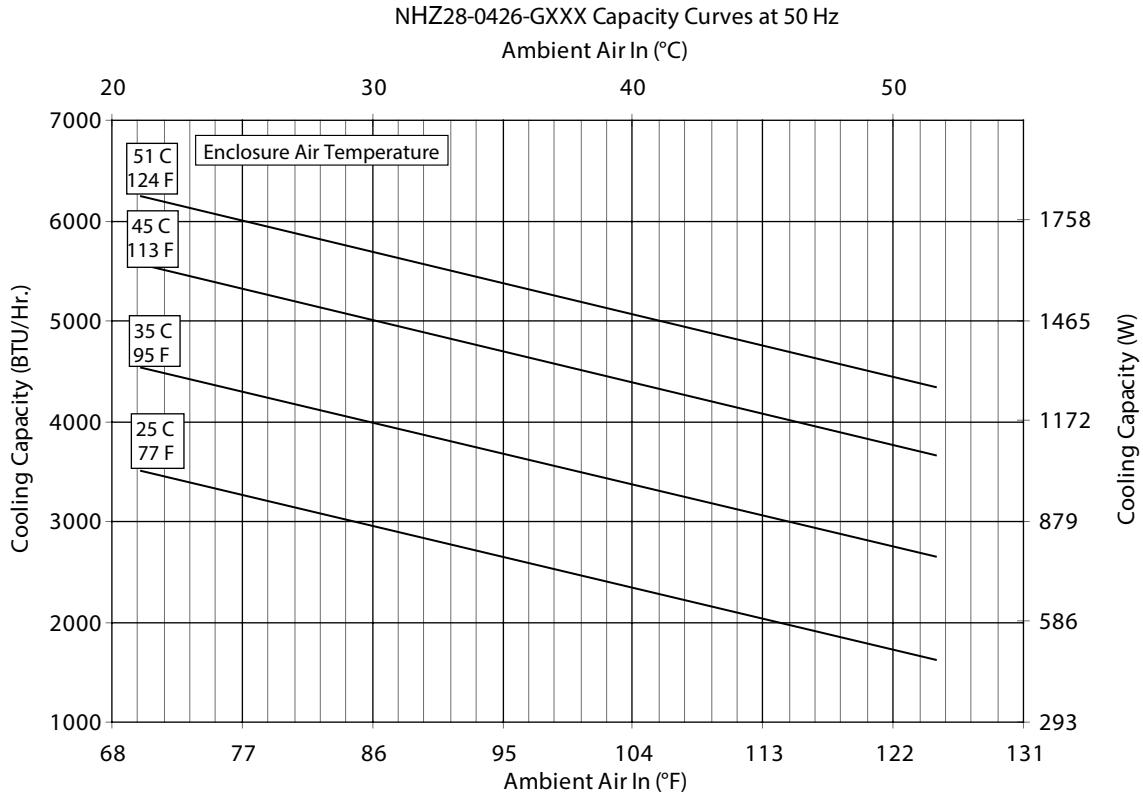

NHZ28 Models 4000 BTU/Hr. (1172 Watt)

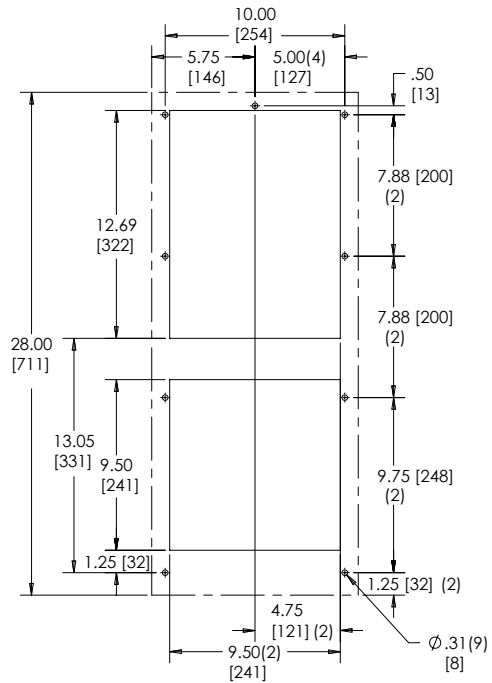
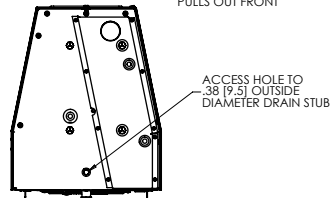
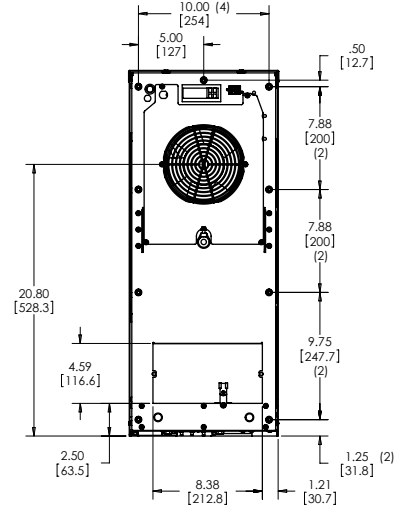
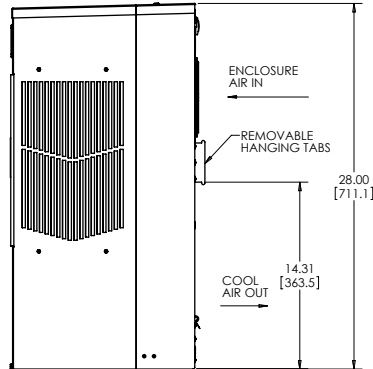
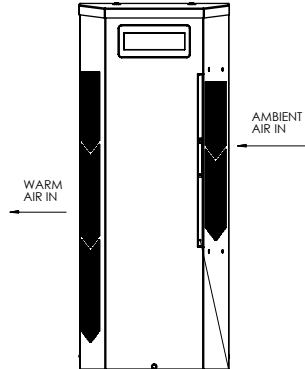
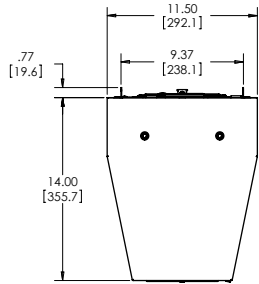

Cutout Dimensions

Visit www.PentairProtect.com to download 2D and 3D CAD drawings into the overall design of your electronic system.

Performance Data **NHZ36 6000/8000 BTU/Hr. (1758/2344 Watt)**

CATALOG NUMBER						
Painted Galvanized Steel Type 4	NHZ360616G300	NHZ360626G300	NHZ360646G300	NHZ360816G300	NHZ360826G300	NHZ360846G300
Painted Galvanized Steel Type 4 with Remote Access Control*	NHZ360616G360	NHZ360626G360	NHZ360646G360	NHZ360816G360	NHZ360826G360	NHZ360846G360
Stainless Steel Type 4X	NHZ360616G400	NHZ360626G400	NHZ360646G400	NHZ360816G400	NHZ360826G400	NHZ360846G400
Stainless Steel Type 4X with Remote Access Control*	NHZ360616G460	NHZ360626G460	NHZ360646G460	NHZ360816G460	NHZ360826G460	NHZ360846G460
Stainless Steel Type 4X Offshore	NHZ360616G500	NHZ360626G500	NHZ360646G500	NHZ360816G500	NHZ360826G500	NHZ360846G500
COOLING PERFORMANCE						
Nominal:						
BTUs/Hr.	5400 / 6000	5400 / 6000	5400 / 6000	8250 / 8500	8250 / 8500	8250 / 8500
Watts	1581 / 1757	1581 / 1757	1581 / 1757	2416 / 2489	2416 / 2489	2416 / 2489
At 131 F / 131 F (55 C / 55 C):						
BTU/Hr. (50 / 60 Hz)	5585 / 6180	5469 / 5965	5300 / 6089	8213 / 8453	7874 / 8063	7777 / 8166
Watts (50 / 60 Hz)	1637 / 1811	1603 / 1748	1553 / 1785	2405 / 2475	2306 / 2361	2277 / 2391
At 95 F / 95 F (35 C / 35 C):						
BTU/Hr. (50 / 60 Hz)	4909 / 5485	5159 / 5621	5572 / 6026	7028 / 7626	6660 / 7411	6877 / 7525
Watts (50 / 60 Hz)	1439 / 1607	1512 / 1647	1633 / 1766	2058 / 2233	1950 / 2170	2014 / 2203
Refrigerant	R134a	R134a	R134a	R134a	R134a	R134a
Refrigerant Charge (ounces/grams)	20 / 567	22 / 624	16 / 454	36 / 1021	36 / 1021	36 / 1021
Operating Temperature Range:						
Maximum (°F / °C)	131 / 55	131 / 55	131 / 55	131 / 55	131 / 55	131 / 55
Minimum (°F / °C)	-40 / -40	-40 / -40	-40 / -40	-40 / -40	-40 / -40	-40 / -40
Air Flow at 0 Static Pressure:						
Internal loop 50 Hz (CFM / M ³ /Hr)	251 / 426	250 / 425	250 / 425	250 / 425	245 / 416	243 / 413
External loop 50 Hz (CFM / M ³ /Hr)	284 / 483	338 / 574	338 / 574	313 / 532	347 / 589	365 / 620
Internal loop 60 Hz (CFM / M ³ /Hr)	261 / 443	261 / 443	261 / 443	263 / 447	258 / 439	254 / 432
External loop 60 Hz (CFM / M ³ /Hr)	311 / 528	356 / 605	356 / 605	338 / 574	382 / 648	394 / 669
ELECTRICAL DATA						
Rated Voltage	115	230	400 / 460 3~	115	230	400 / 460 3~
Frequency (Hz)	50 / 60	50 / 60	50 / 60	50 / 60	50 / 60	50 / 60
Operating Range	+/-10%	+/-10%	+/-10%	+/-10%	+/-10%	+/-10%
Max. Power Consumption (Watts at 50 / 60 Hz)	911 / 1108	908 / 1073	691 / 783	1206 / 1422	1265 / 1403	572 / 628
Max. Nominal Current (Amps at 50 / 60 Hz)	9.1 / 10.1	4.5 / 4.7	1.7 / 1.8	11.2 / 12.4	5.5 / 6.2	3.0 / 3.4
Starting Current (Amps)	39.2	23	8.1	48.3	27	16
Agency Approvals	cUL Listed CE Others available upon request					
Power Input Description	Terminal Block					
ENCLOSURE PROTECTION						
UL Type	Type 4, 4X Standard					
CONTROLLER						
Description	Digital Controller					
Controller Location	Enclosure Side					
Factory Controller Setting (°F / °C)	80 / 27					
SOUND LEVEL						
At 1.5 Meters	66.9 dBA	66.7 dBA	68.2 dBA	66.0 dBA	66.0 dBA	66.0 dBA
UNIT CONSTRUCTION						
Material	Galvanized Sheet Metal Type 4 Models Stainless steel 316L Type 4X and Offshore Models					
Finish	RAL 7035 light-gray, semi-textured powder-coat paint standard Other colors available					
UNIT DIMENSIONS						
Height (in / mm)	36.00 / 914.4					
Width (in / mm)	11.50 / 292.1					
Depth (in / mm)	14.00 / 355.6					
Weight (lb / kg)	100 / 45	100 / 45	104 / 47	106 / 48	106 / 48	114 / 52

*Units with Remote Access Control utilize a digital controller and communicate via EtherNet/IP, Profinet, Modbus TCP/IP and SNMP over ethernet or modbus RTU over USB.

Performance Curves for NHZ36 Models 6000 BTU/Hr. (1758 Watt)

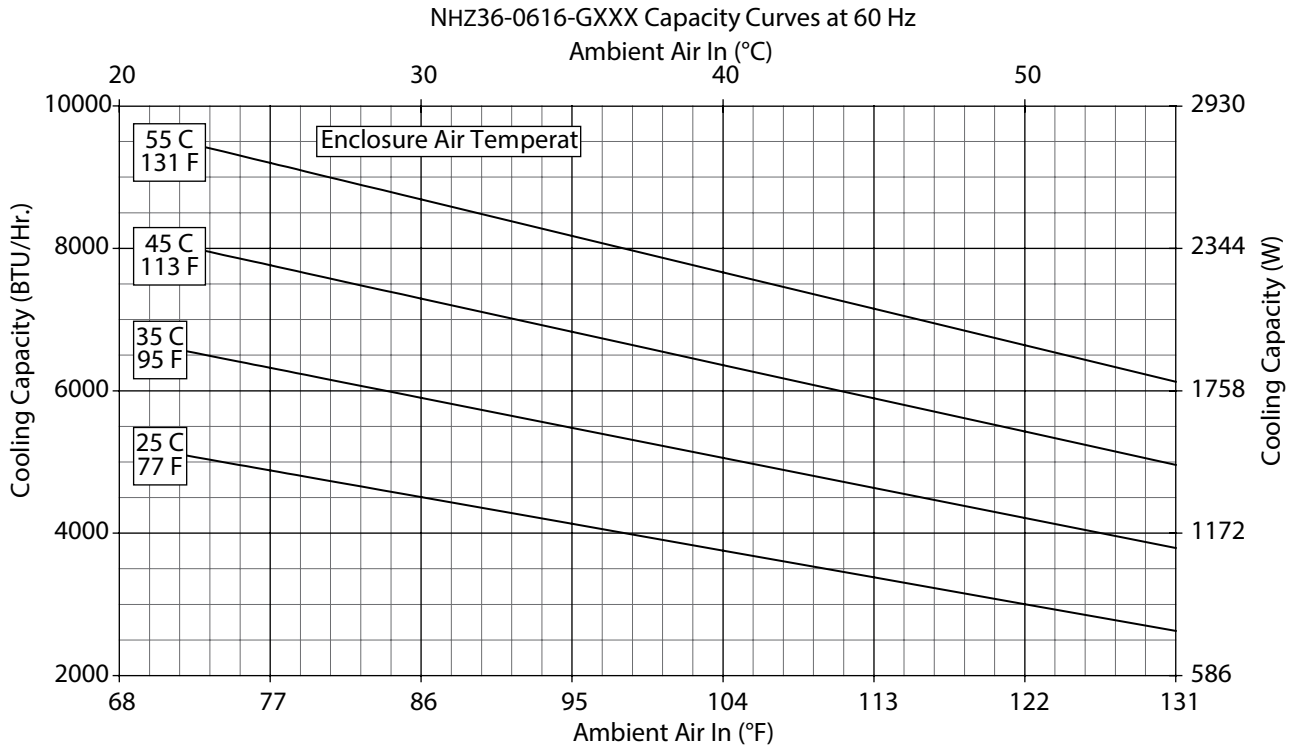
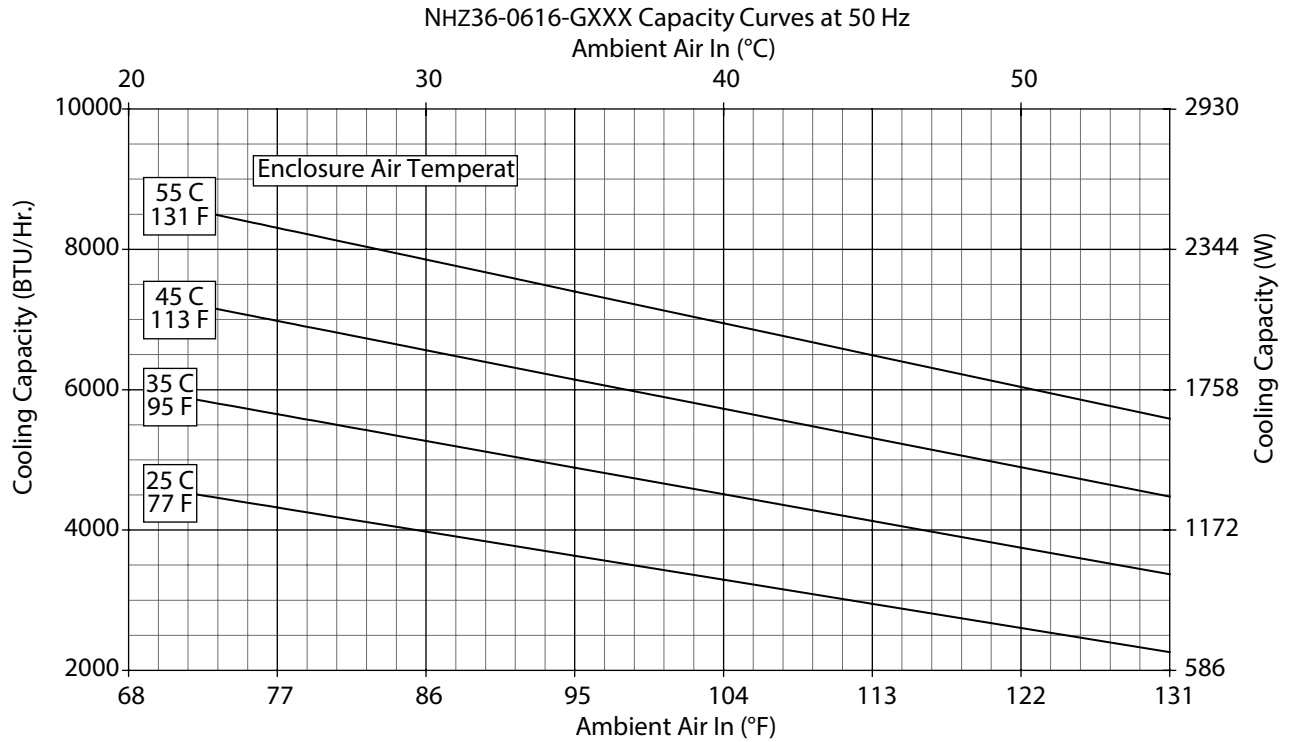

Performance Curves for NHZ36 Models 6000 BTU/Hr. (1758 Watt)

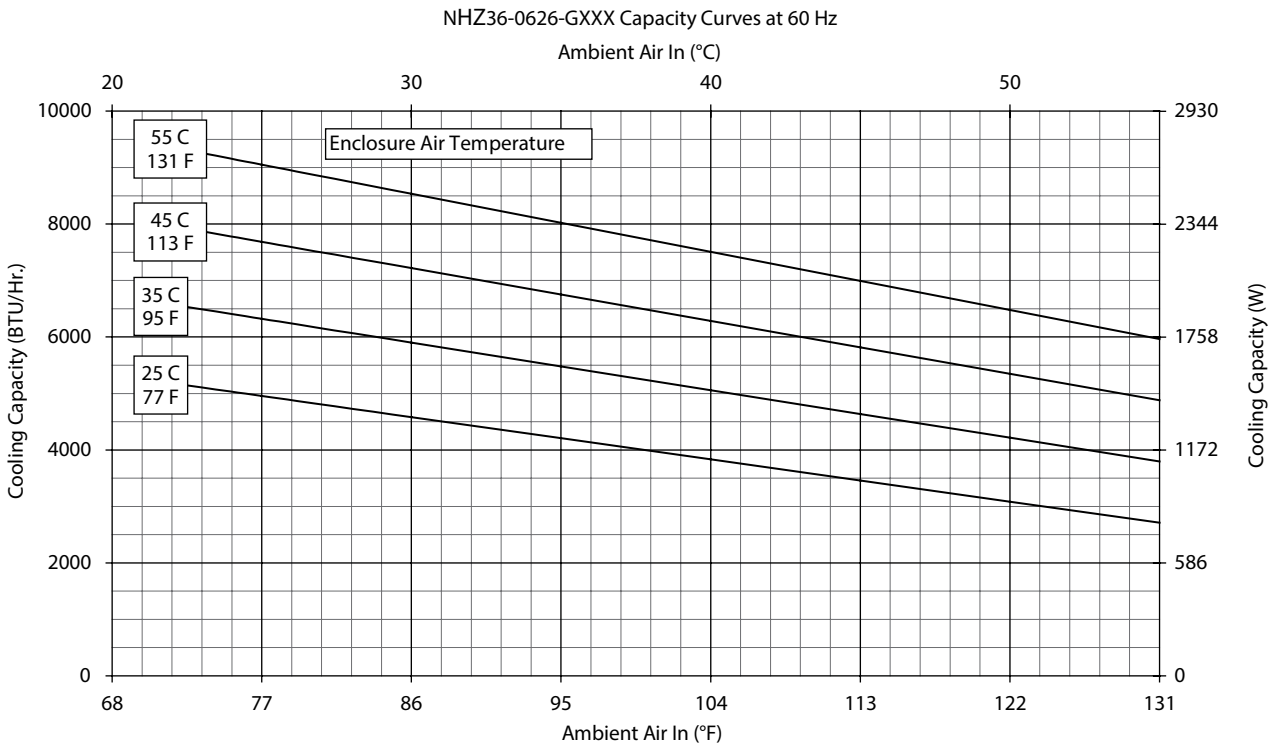
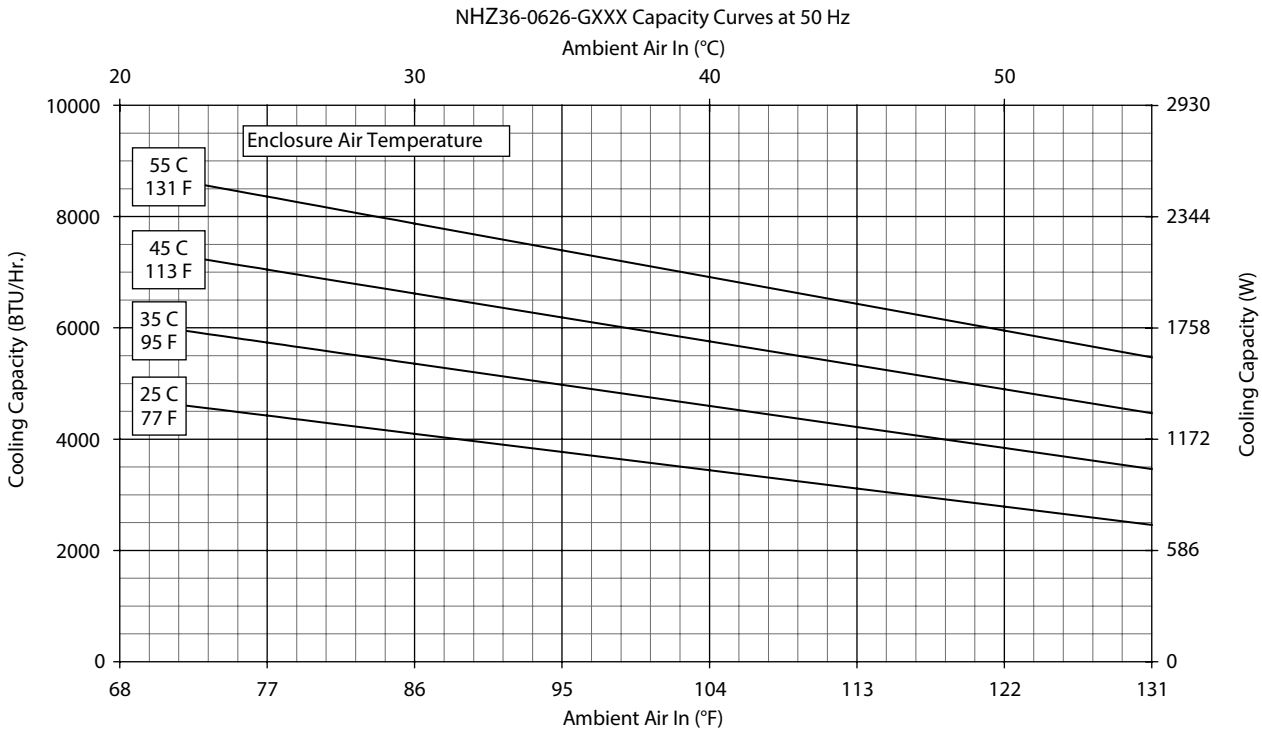

Performance Curves for NHZ36 Models 6000 BTU/Hr. (1758 Watt)

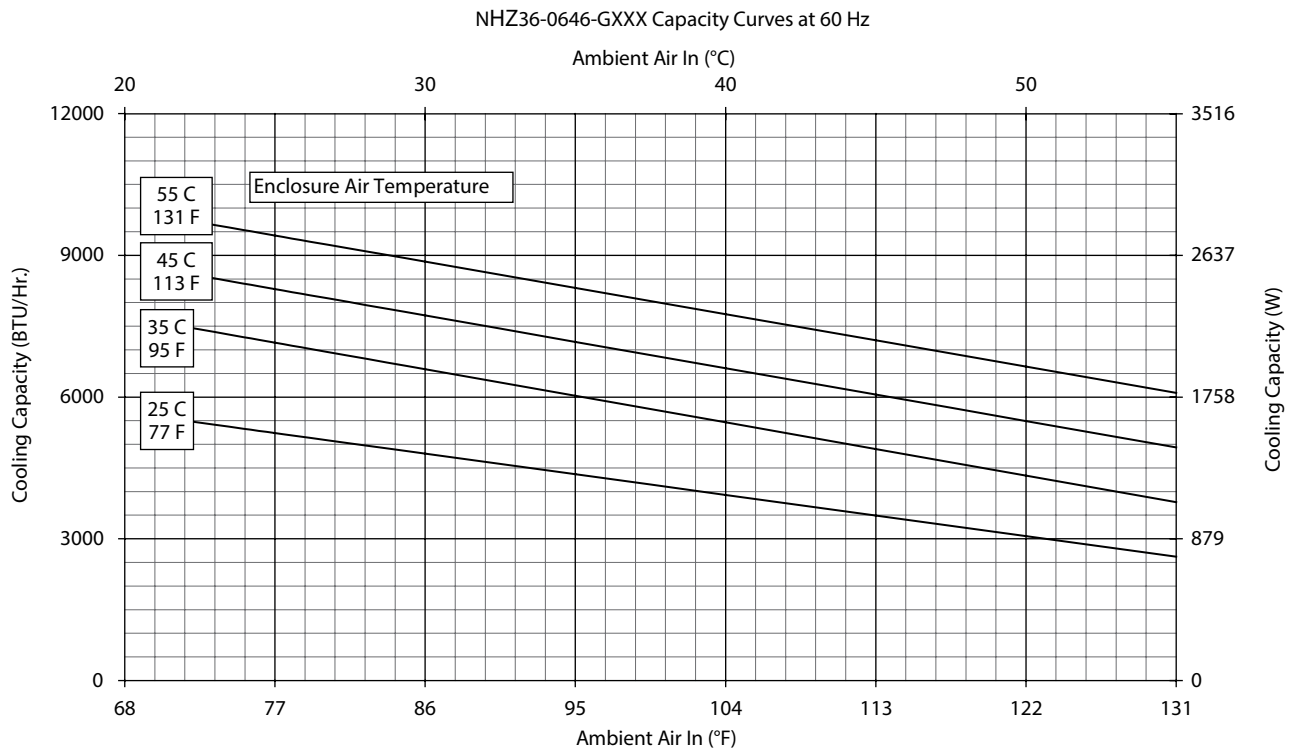
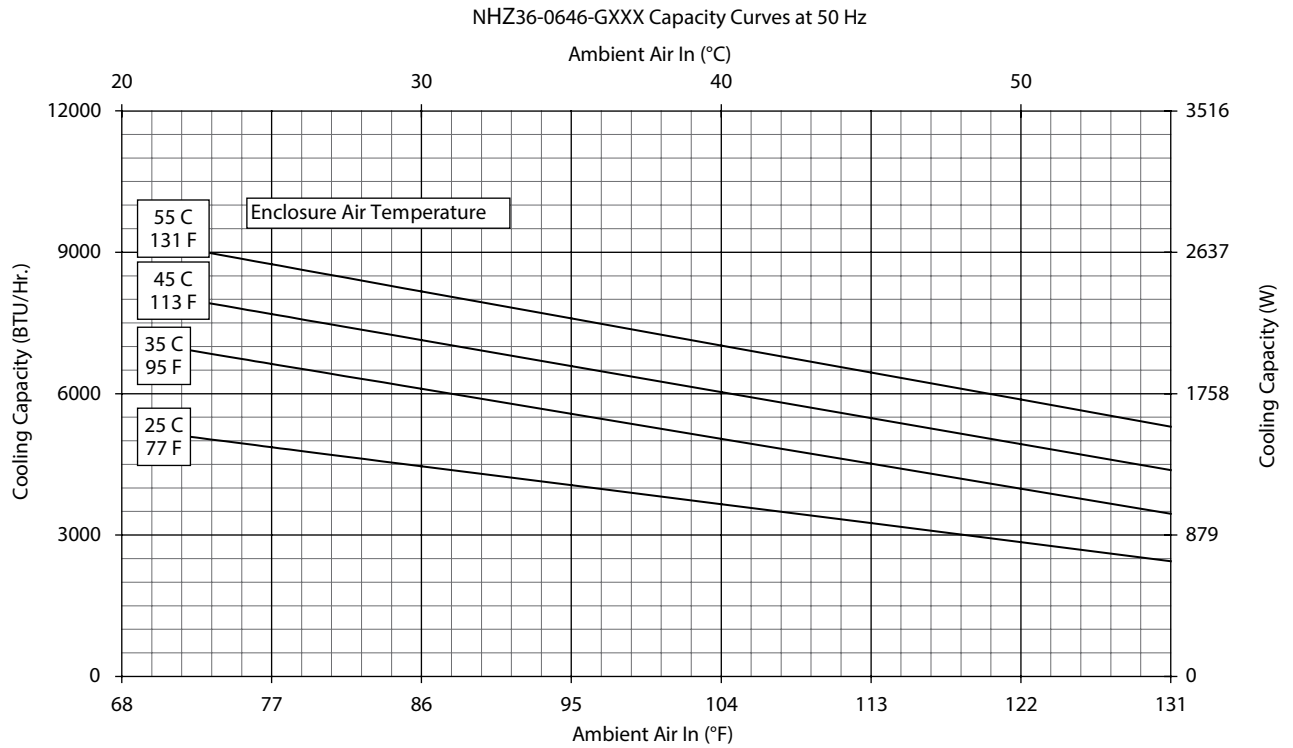

Performance Curves for NHZ36 Models 8000 BTU/Hr. (2344 Watt)

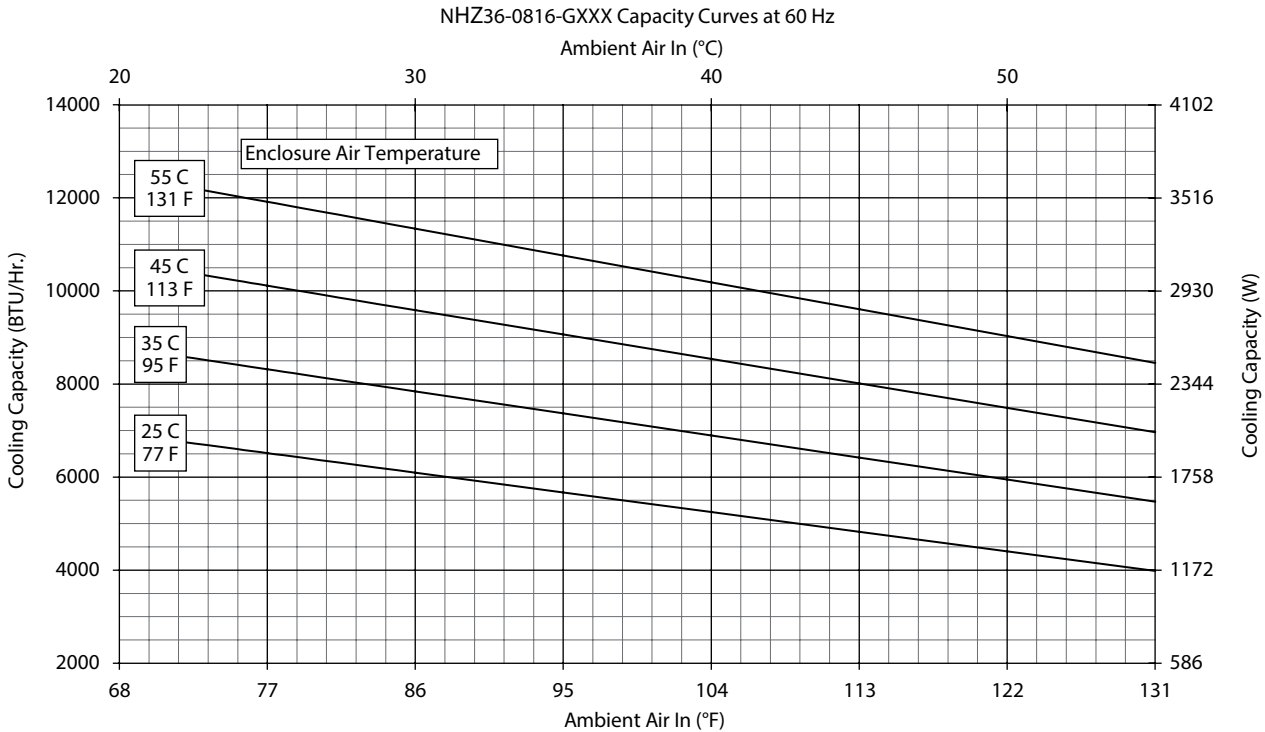
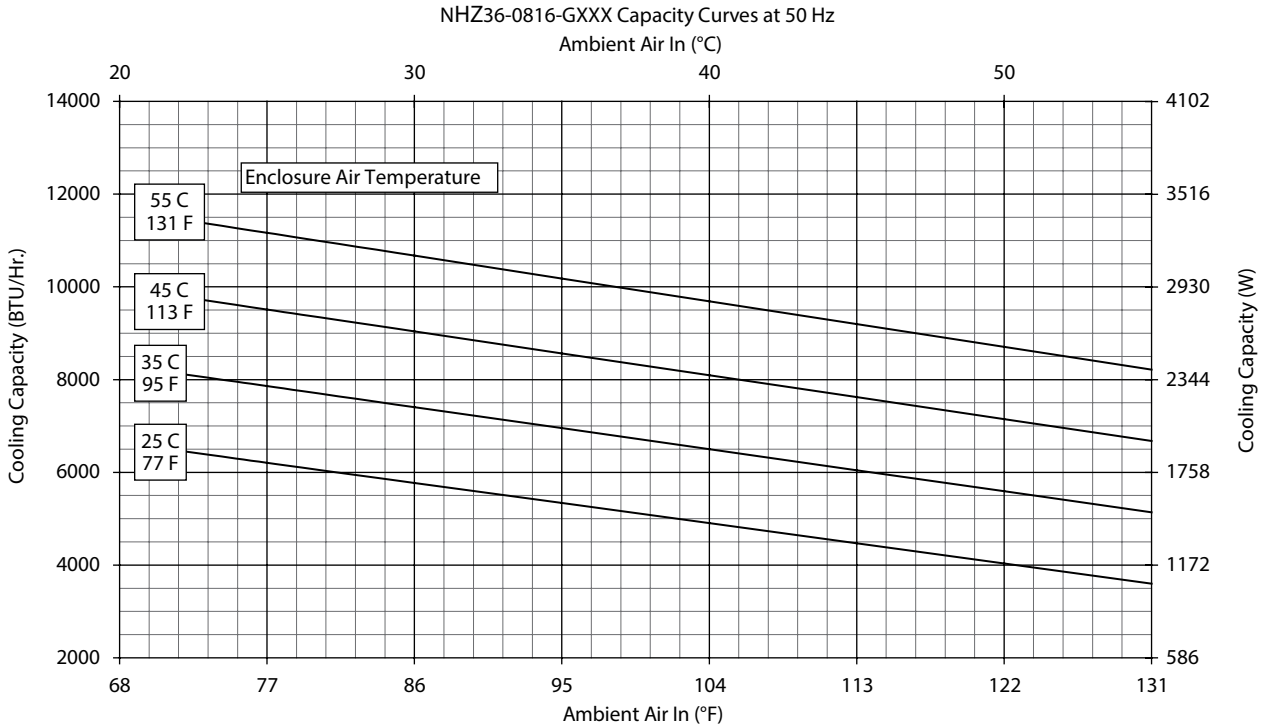

Performance Curves for NHZ36 Models 8000 BTU/Hr. (2344 Watt)

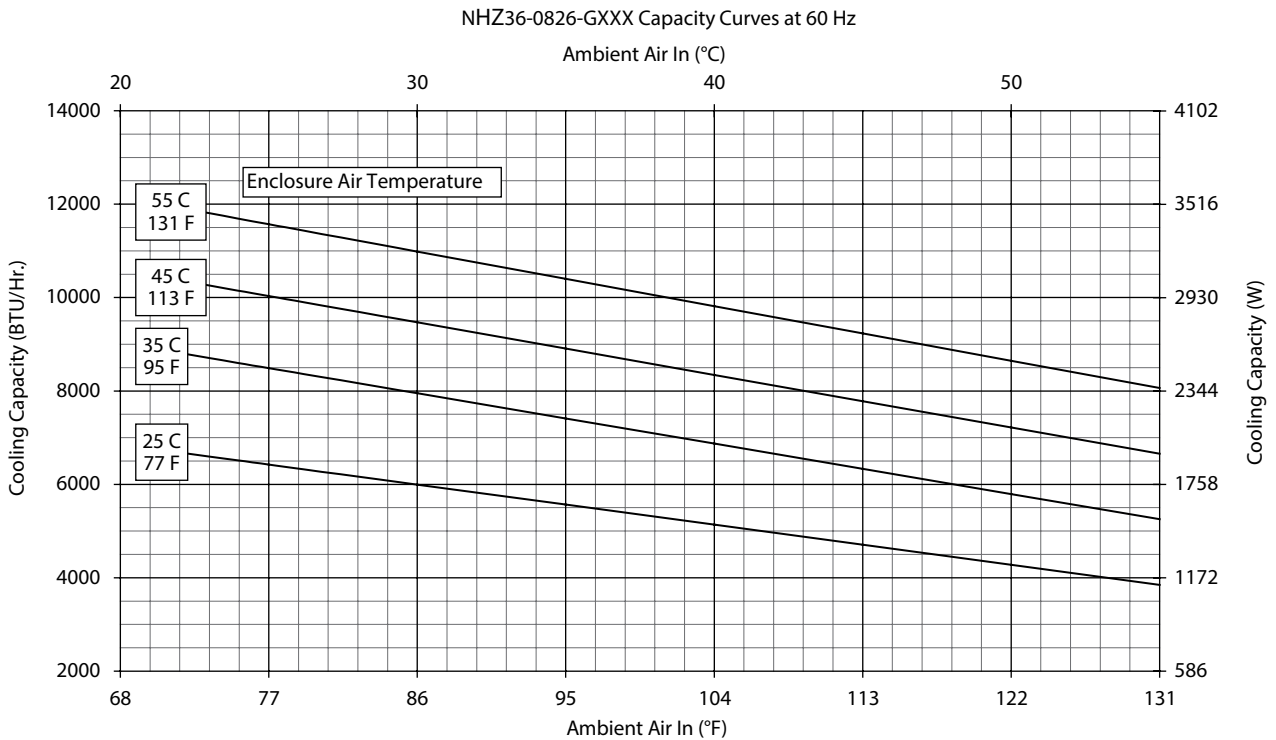
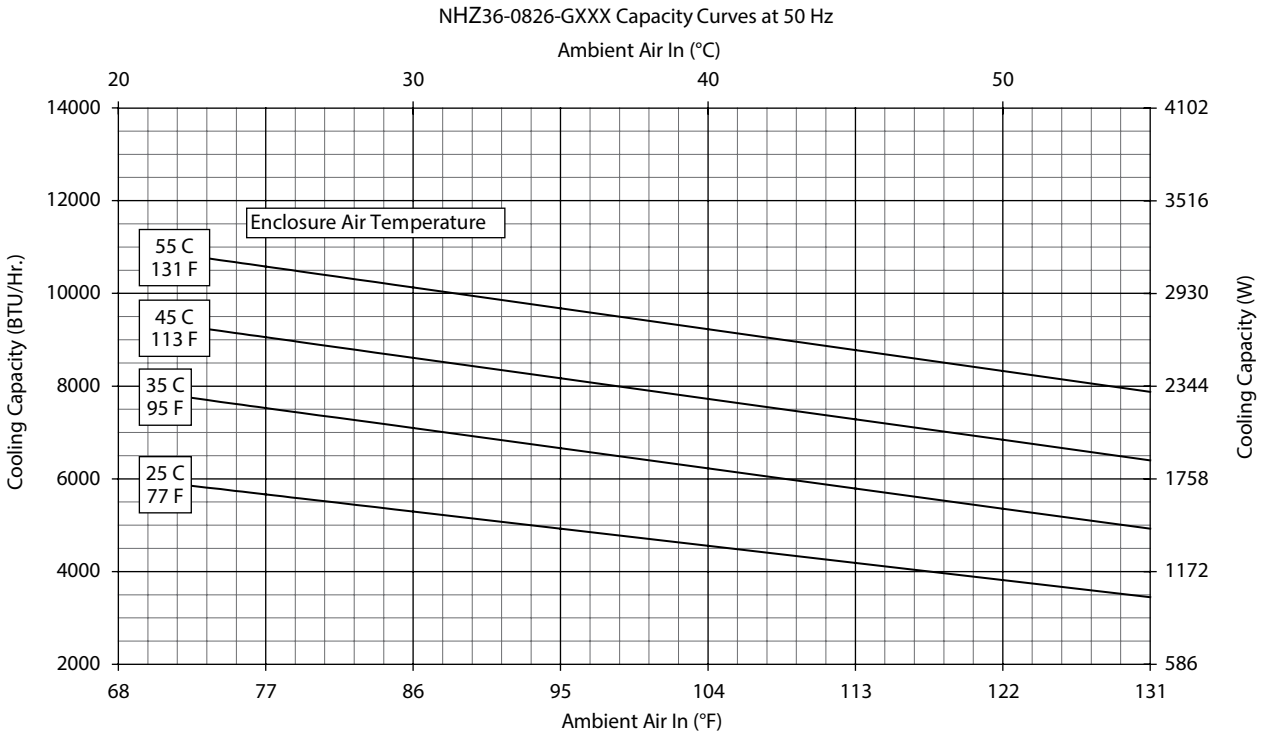

Performance Curves for NHZ36 Models 8000 BTU/Hr. (2344 Watt)

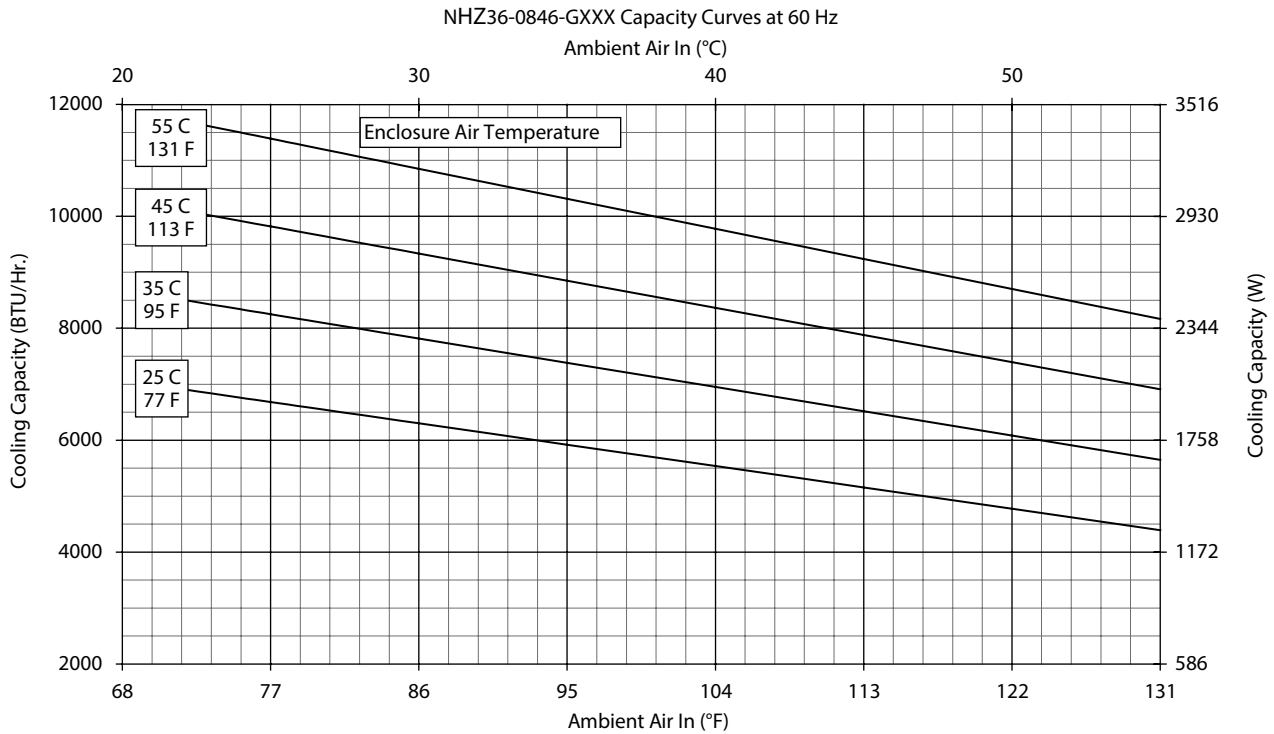
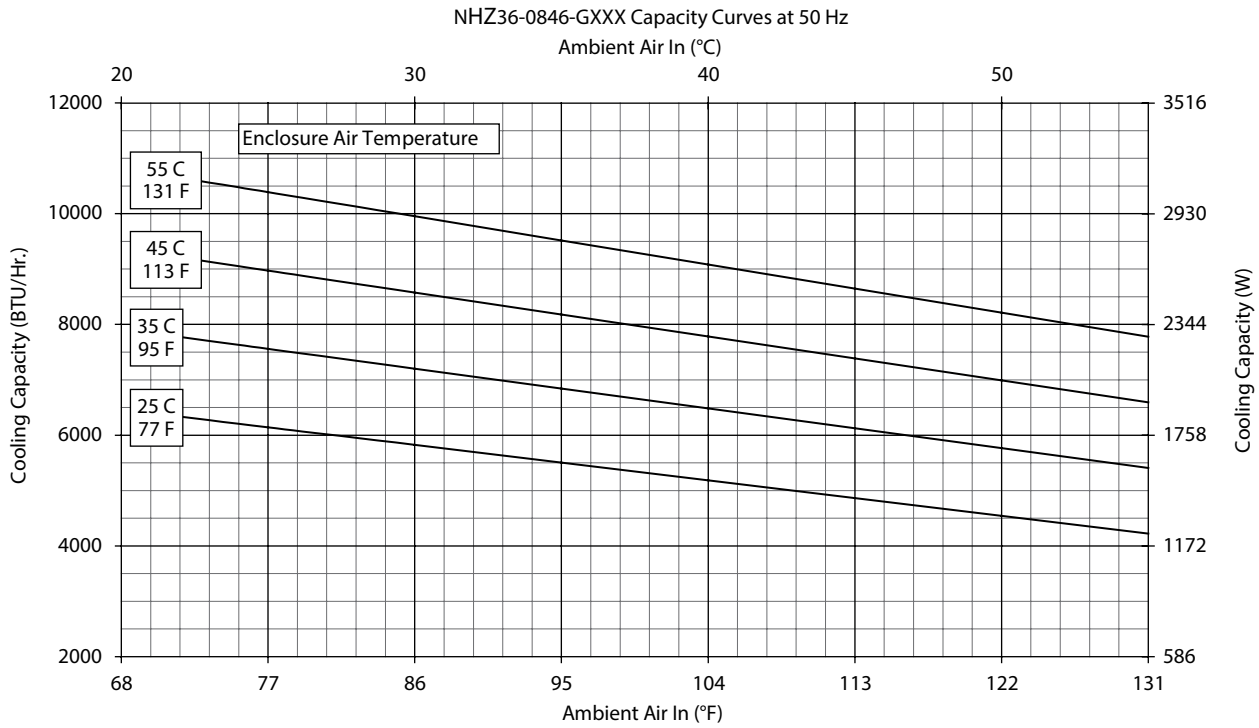

NHZ36 6000/8000 BTU/Hr. (1758/2344 Watt)

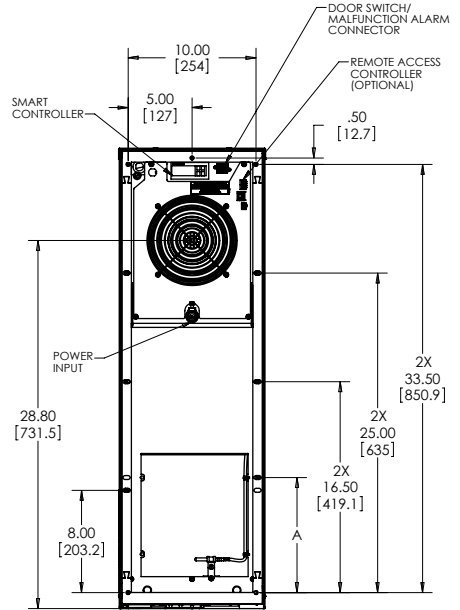
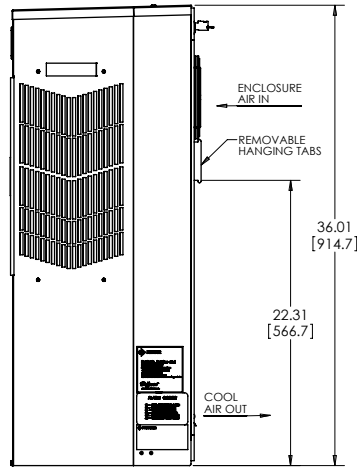
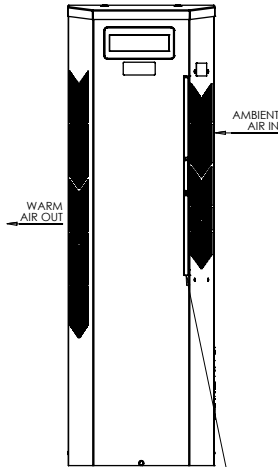
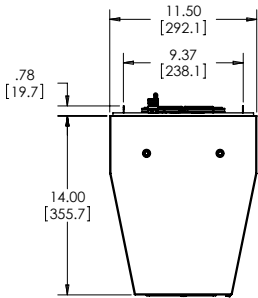

CLEANABLE, REUSABLE ALUMINUM INLET AIR FILTER PULLS OUT FRONT

89115570

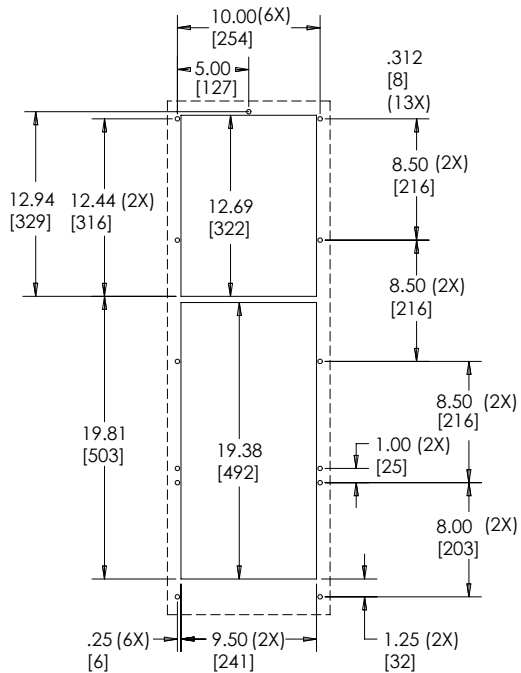
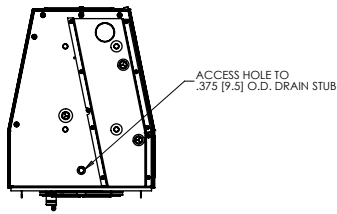

Cutout Dimensions

Visit www.PentairProtect.com to download 2D and 3D CAD drawings into the overall design of your electronic system.

Performance Data **NHZ43 11000 BTU/Hr. (3223 Watt)**

CATALOG NUMBER			
Painted Galvanized Steel Type 4	NHZ431216G300	NHZ431226G300	NHZ431246G300
Painted Galvanized Steel Type 4 with Remote Access Control*	NHZ431216G360	NHZ431226G360	NHZ431246G360
Stainless Steel Type 4X	NHZ431216G400	NHZ431226G400	NHZ431246G400
Stainless Steel Type 4X with Remote Access Control*	NHZ431216G460	NHZ431226G460	NHZ431246G460
Stainless Steel Type 4X Offshore	NHZ431216G500	NHZ431226G500	NHZ431246G500
COOLING PERFORMANCE			
Nominal:			
BTUs/Hr.	10400 / 11000	10400 / 11000	10400 / 11000
Watts	3047 / 3223	2900 / 3223	2900 / 3223
At 131 F / 131 F (55 C / 55 C):			
BTU/Hr. (50 / 60 Hz)	10588 / 11180	9946 / 11052	10048 / 10797
Watts (50 / 60 Hz)	3103 / 3277	2915 / 3239	2945 / 3164
At 95 F / 95 F (35 C / 35 C):			
BTU/Hr. (50 / 60 Hz)	9475 / 10023	8967 / 9644	8587 / 9559
Watts (50 / 60 Hz)	2777 / 2937	2628 / 2826	2517 / 2801
Refrigerant	R134a	R134a	R134a
Refrigerant Charge (ounces/grams)	36 / 1021	38 / 1077	41 / 1162
Operating Temperature Range:			
Maximum (°F / °C)	125 / 52	131 / 55	131 / 55
Minimum (°F / °C)	-40 / -40	-40 / -40	-40 / -40
Air Flow at 0 Static Pressure:			
Internal loop 50 Hz (CFM / M ³ /Hr)	239 / 406	259 / 440	254 / 432
External loop 50 Hz (CFM / M ³ /Hr)	494 / 839	489 / 831	341 / 579
Internal loop 60 Hz (CFM / M ³ /Hr)	250 / 425	267 / 454	260 / 442
External loop 60 Hz (CFM / M ³ /Hr)	528 / 897	525 / 892	564 / 958
ELECTRICAL DATA			
Rated Voltage	115	230	400 / 460 3-
Frequency (Hz)	50 / 60	50 / 60	50 / 60
Operating Range	+/-10%	+/-10%	+/-10%
Max. Power Consumption (Watts at 50 / 60 Hz)	1620 / 2061	1802 / 2446	1294 / 1421
Max. Nominal Current (Amps at 50 / 60 Hz)	15.1 / 18.2	9.0 / 9.1	3.4 / 3.5
Starting Current (Amps)	57	38	16
Agency Approvals		cUL Listed CE	
Power Input Description		Others available upon request	Terminal Block
ENCLOSURE PROTECTION			
UL Type		Type 4, 4X Standard	
CONTROLLER			
Description		Digital Controller	
Controller Location		Enclosure Side	
Factory Controller Setting (°F / °C)		80 / 27	
SOUND LEVEL			
At 1.5 Meters	68.4 dBA	68.4 dBA	69.6 dBA
UNIT CONSTRUCTION			
Material		Galvanized Sheet Metal Type 4 Models Stainless steel 316L Type 4X and Offshore Models	
Finish		RAL 7035 light-gray, semi-textured powder-coat paint standard Other colors available	
UNIT DIMENSIONS			
Height (in / mm)		43.00 / 1092.2	
Width (in / mm)		11.50 / 292.1	
Depth (in / mm)		14.00 / 355.6	
Weight (lb / kg)	127/57.6	127/57.6	138/62.6

*Units with Remote Access Control utilize a digital controller and communicate via EtherNet/IP, Profinet, Modbus TCP/IP and SNMP over ethernet or modbus RTU over USB.

Performance Curves for NHZ43 Models 11000 BTU/Hr. (3223 Watt)

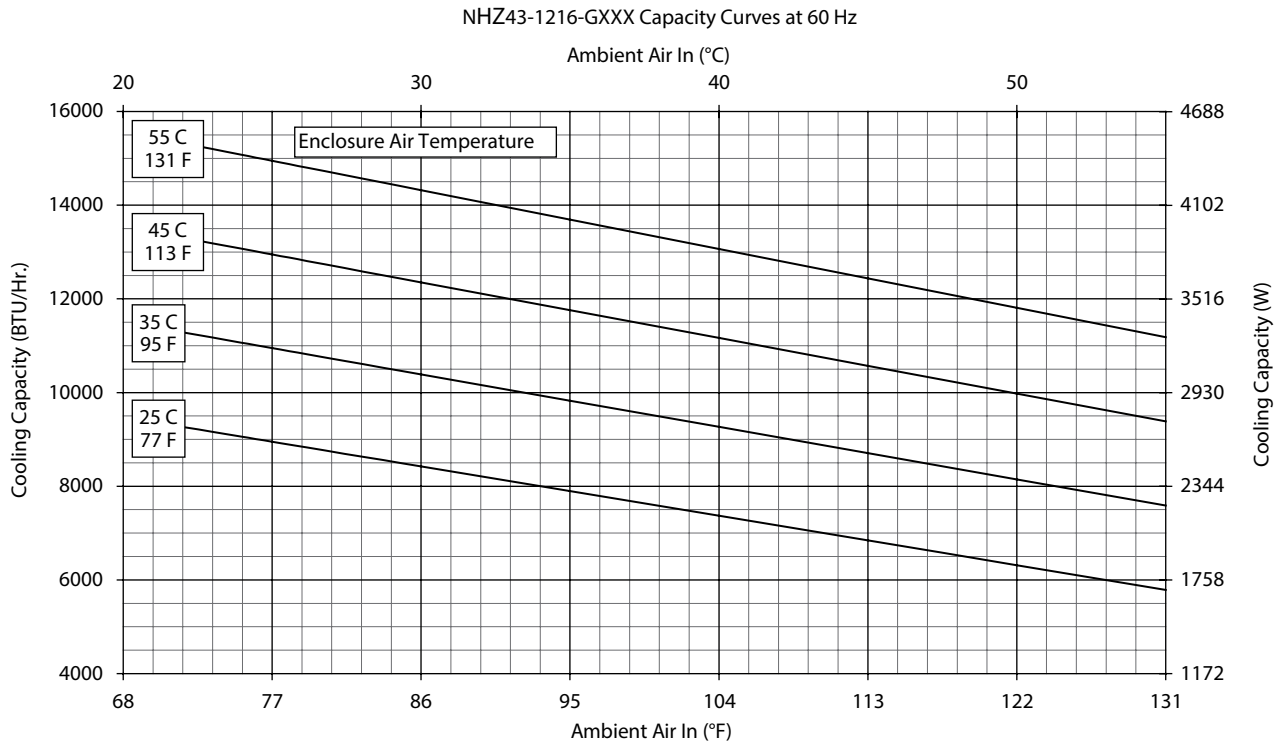
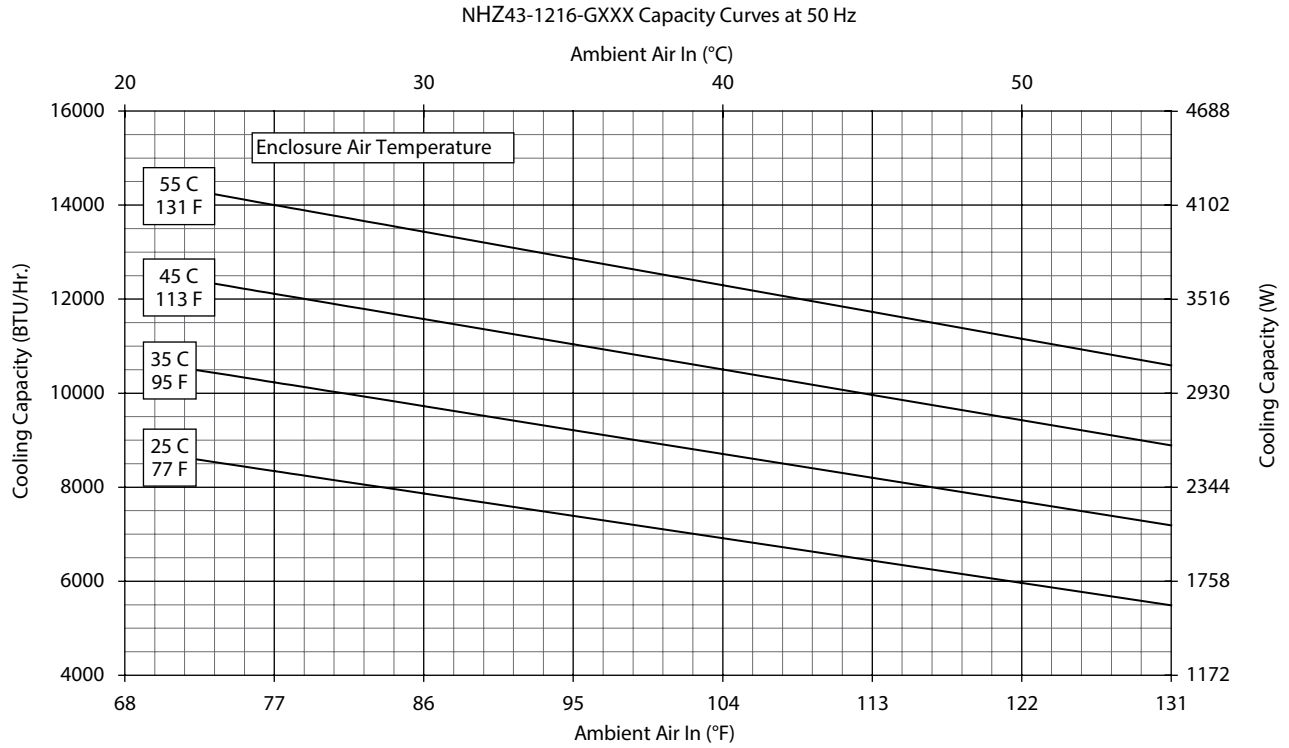

Performance Curves for NHZ43 Models 11000 BTU/Hr. (3223 Watt)

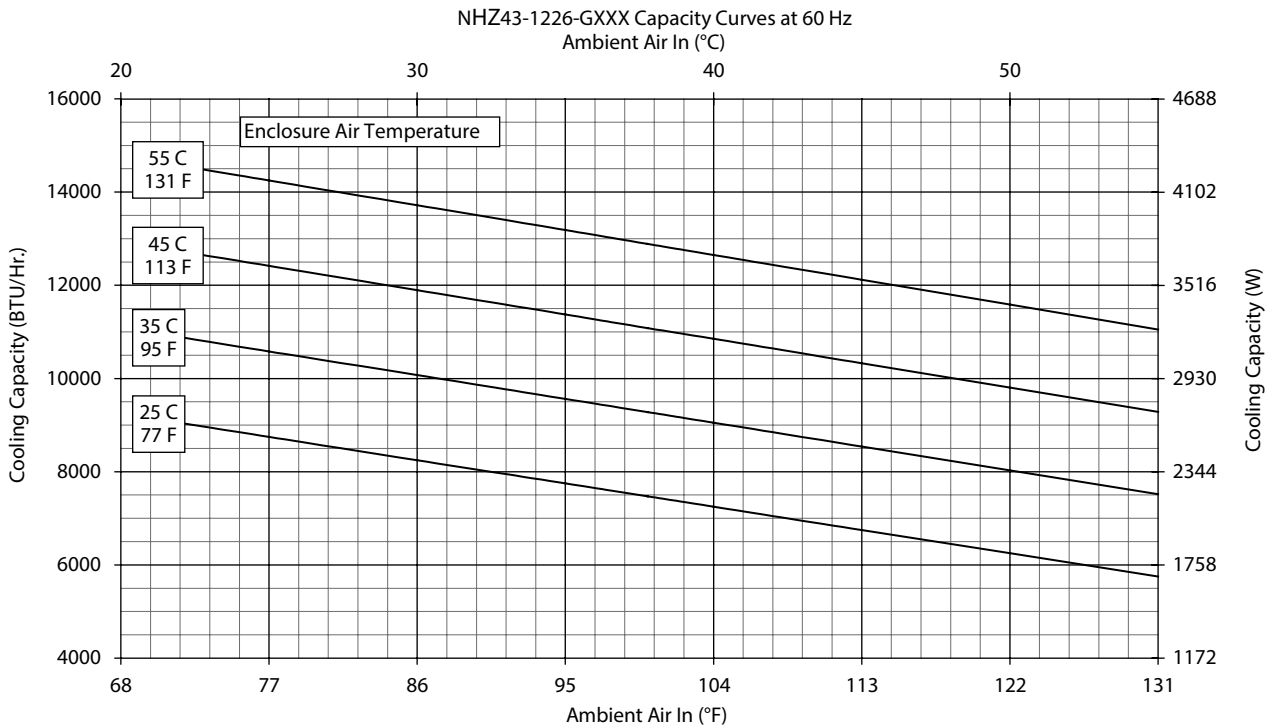
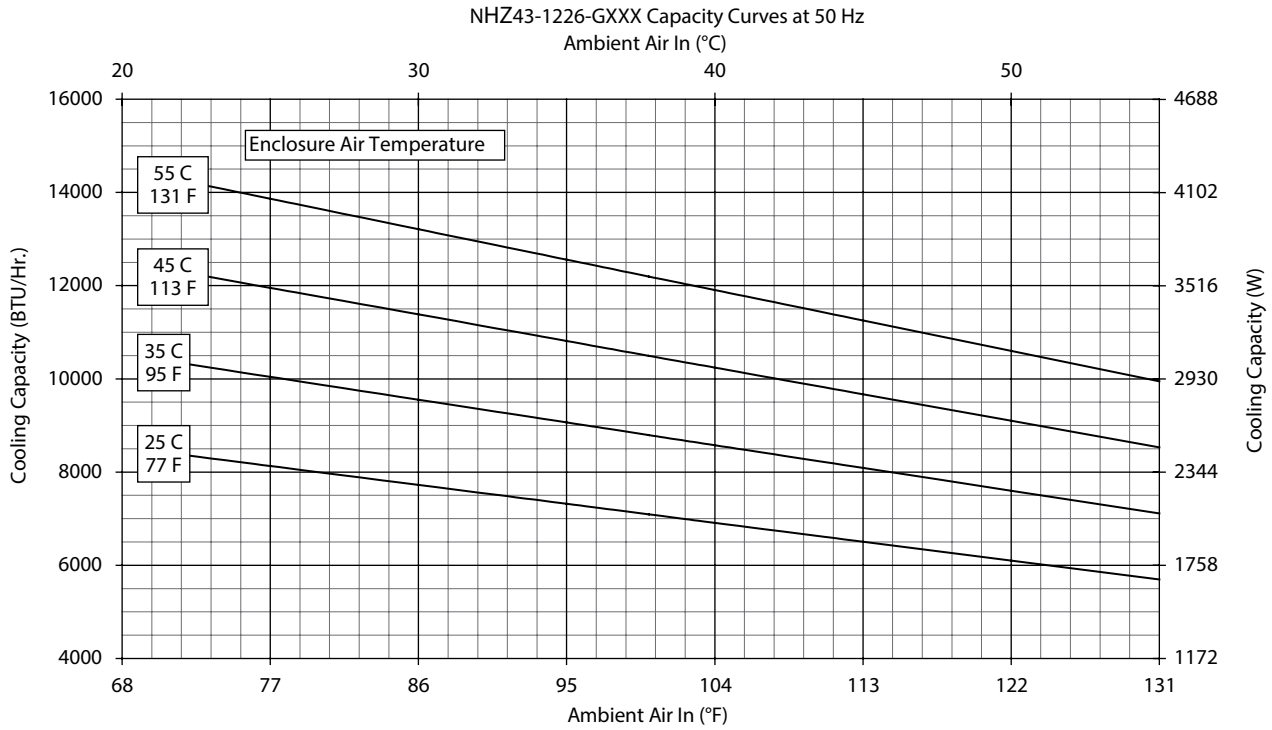

Performance Curves for NHZ43 Models 11000 BTU/Hr. (3223 Watt)

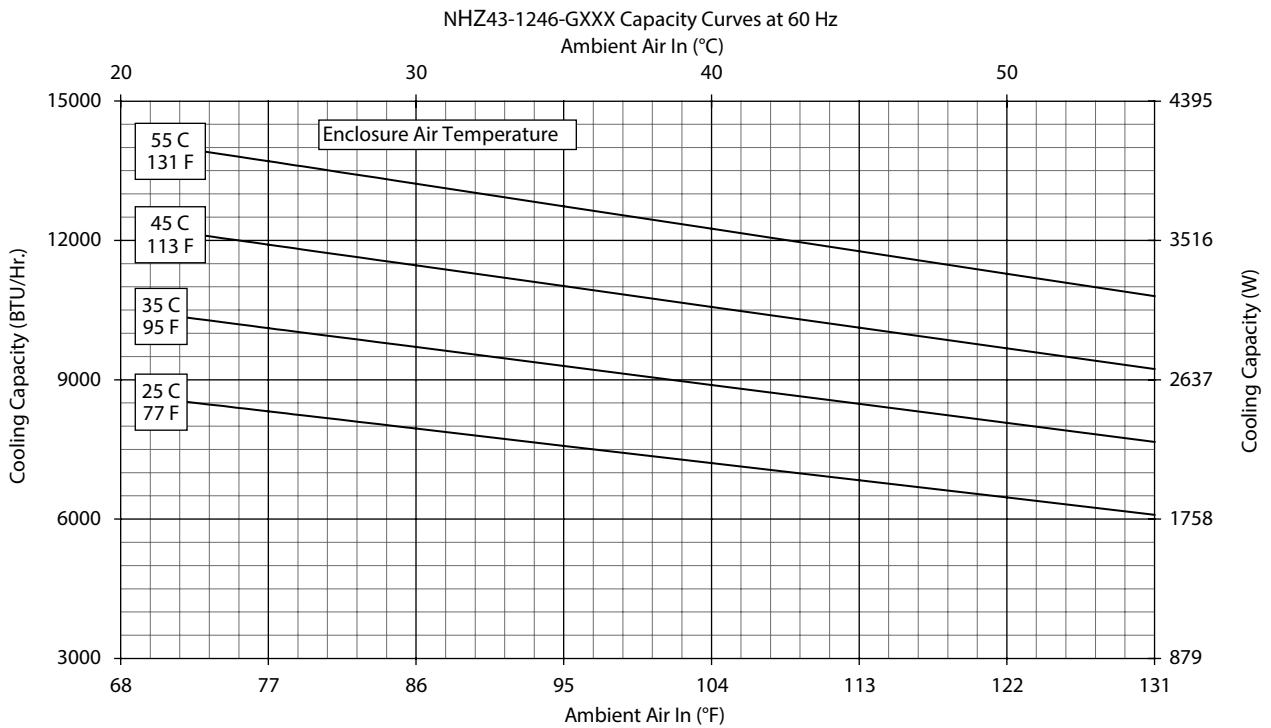
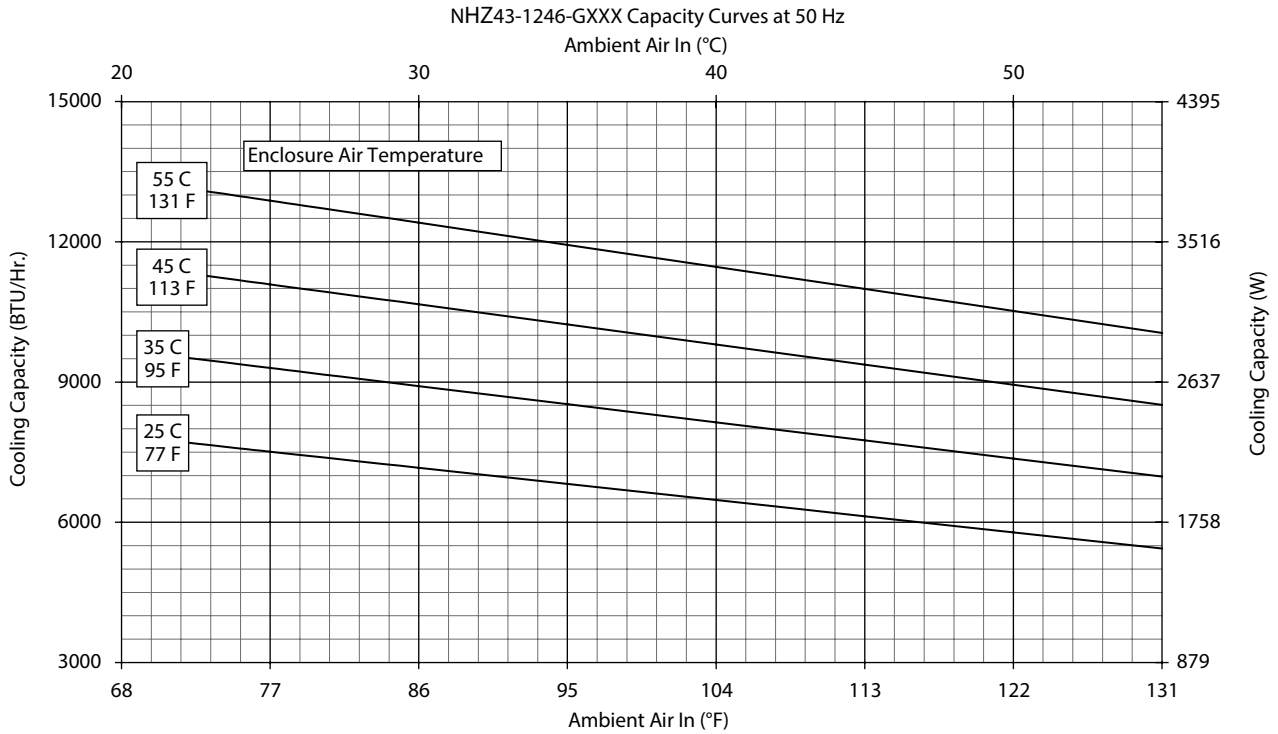

NHZ43 11000 BTU/Hr. (3223 Watt)

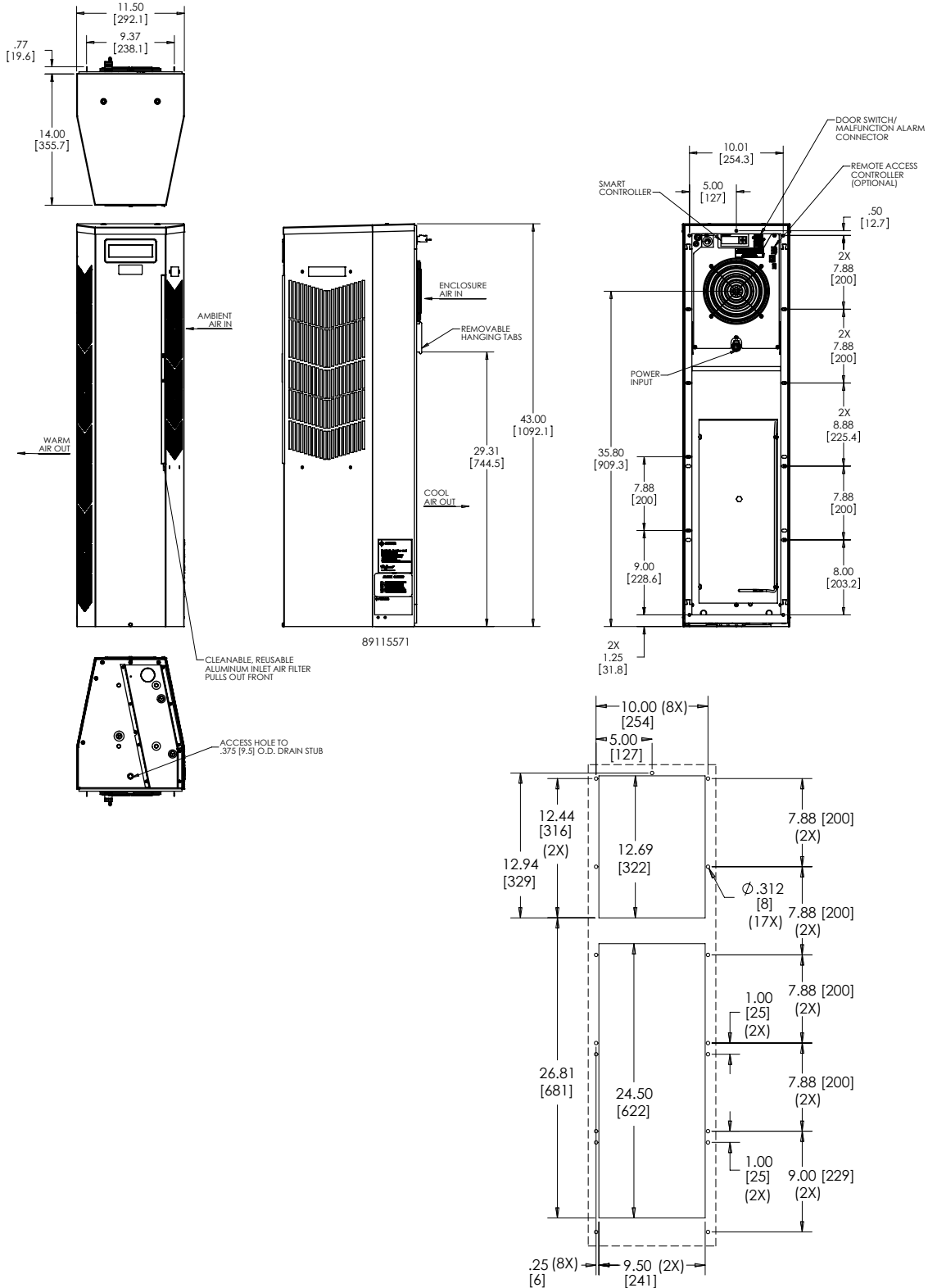

CUTOUT INSTRUCTIONS

Visit www.PentairProtect.com to download 2D and 3D CAD drawings into the overall design of your electronic system.