

7-16 DIN Male Connector for 1/2" Coaxial Cable, OMNI FIT™ Premium, Straight, Polymer claw and compression sealing

Product Description

OMNI FIT™ high performance connectors are designed for use with both CELLFLEX® (copper) and CELLFLEX® Lite (aluminium) cables. They are designed specifically to provide the highest quality connector-cable interface while simplifying and speeding up connector attachment. All RFS connectors are fully tested for mechanical and electrical compliance to industry specifications. The 7-16 connector is the most rugged RF connection meeting all requirements even under the most severe environmental conditions. Sealing against outer conductor and jacket by means of the polymer claw and 360° compression fit. Multifunctional, self-lubricating HighTech polymer assembly locks on cable corrugation, avoids electrochemical potential differences and compression-fits to the jacket.



OMNI FIT™ Premium Connectors

Features/Benefits

- Ultra high PIM performance i.e. reduced interference leading to high customer satisfaction
- Two-piece design i.e. visual inspection of interlocking leads to improved installation security
- OMNI FIT™ concept i.e. streamlined order management and reduced stock level
- Watertight sealing in mated and unmated condition, i.e. reduced efforts during installation and improved security during operation
- Unique NiTin plating i.e. extreme resistance against corrosion even under hardest climatic and environmental circumstances
- Multi-thread (Tristart) design i.e. simplified and accelerated tightening process
- RoHS (EU) and CRoHS (China) compliant i.e. can be used on a global basis

Technical Specifications

Transmission Line Type	Coaxial Cable
Cable Size	1/2"
Cable Type	Foam Dielectric
Model Series	LCF12-50 Series, ICA12-50 Series
Connector Interface	7-16 DIN
Nominal Impedance, ohms	50
Connector Type	OMNI FIT™ PREMIUM Straight
Sealing Method	Polymer claw + 360° Compression
Gender	Male
Plating Outer/Inner	NiTin/Silver
Length, mm (in)	55.8 (2.2)
Outer Diameter, mm (in)	32 (1.26)
Weight, kg (lb)	0.15 (0.33)
Inner Contact Attachment	Basket
Outer Contact Attachment	360° clamping
3rd Order IM Product @ 2x20 Watts, dBc	-163 ; typical -167
Maximum Frequency, GHz	3.7
VSWR (Return Loss, dB)	0 < f = 1.0 GHz: 1.02 (40.0) 1.0 < f = 2.7 GHz: 1.03 (36.6) 2.7 < f = 3.7 GHz: 1.06 (30.7)
Wrench size front, mm (in)	26
Wrench size rear, mm (in)	26
Trimming Tool	TRIM-SET-L12-D01 TRIM-LCF12-D01-A
Waterproof Level	IP68

Notes

Other Documentation

Installation Instruction: [2800130-B.pdf](#)



7-16 DIN Male Connector for 1/2" Coaxial Cable, OMNI FIT™ Premium, Straight, Polymer claw and compression sealing

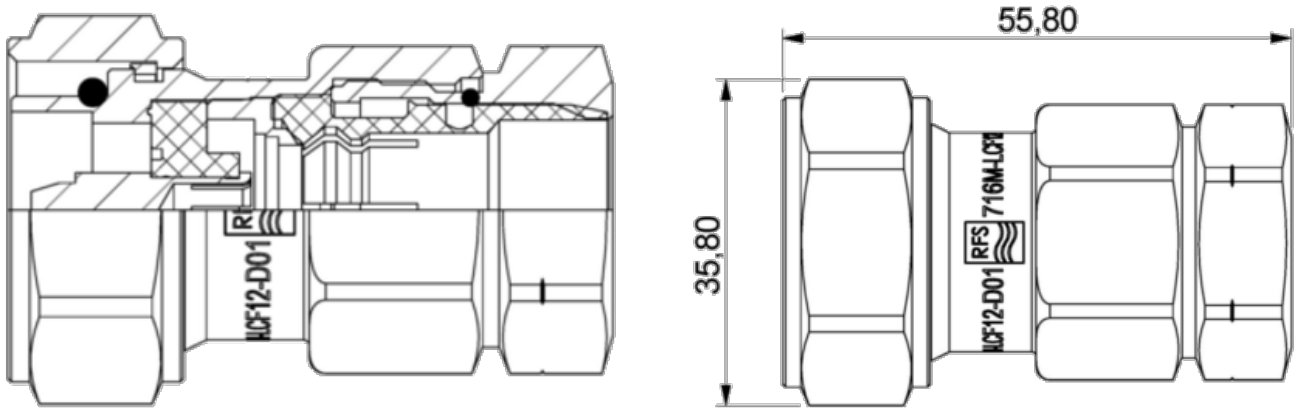

All information contained in the present datasheet is subject to confirmation at time of ordering