

Installation Instructions

Model Number 1078-WA

Model 1078-WA Locking Recess Wall/Ceiling Mount Assembly Components:

- Ceiling enclosure Model 1078-WA assembly – 1 each
- Wall bridge – 2 each
- #8-32 X 3/8 " screw – 4 each
- #8-32 nut – 4 each
- 3/4" Trade size conduit connector – 1 each
- Fire block foam – 1 each
- Keys for access door lock – 2 each
- Installation instructions – 1 each
- Eyebolt – 4 each
- Support wire – 4 each



If any of these items are missing, contact your Oberon representative.

Find a flat work surface to assemble the enclosure, access point and antenna(s) (if needed) prior to mounting in wall or ceiling.

Step 1 - Cut a 13" horizontal x 13.4" vertical opening in the "hard lid" ceiling or wall (special cutting tools may be required – ref. Figure 1).

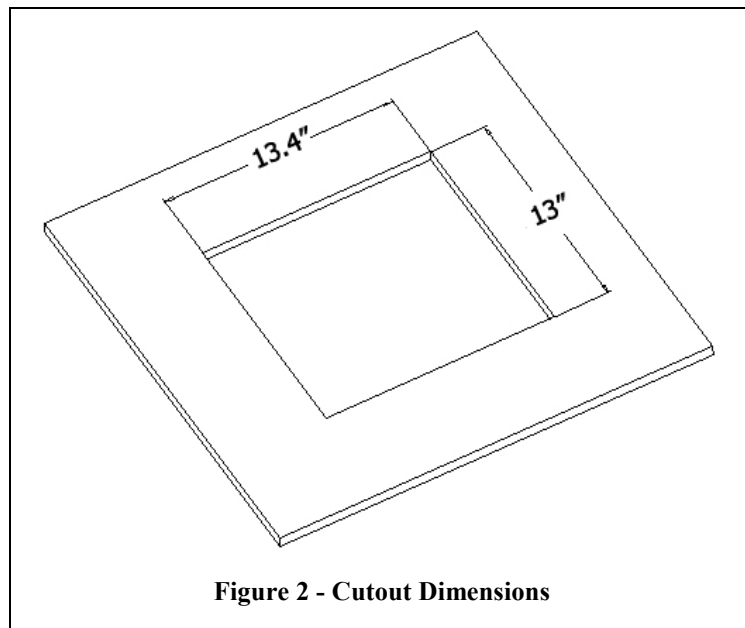

Figure 2 - Cutout Dimensions

Step 2 – Place the enclosure assembly on the work surface. Remove one of the 1" trade size hole cover on the side of the enclosure and install the 1" trade size conduit connector (the side on which the trade size cable clamp is to be installed will be determined by the location the enclosure is to be installed and direction from which conduit will be brought into the enclosure – ref. Figure 2).

Step 3 – Place the (2) two wall bridges in the mounting position by loosening the (4) four wing nuts inside of the enclosure. The position of the wall bridges will look like the image in Figure 3. Place the enclosure in to the hole that was cut in Figure 1. Angle the enclosure at 10° with the wall

so the bridges extended towards the bottom. The wall bridges will go in first. Once the bottom of the enclosure is in the hole push the enclosure so it is flush with the wall or ceiling.

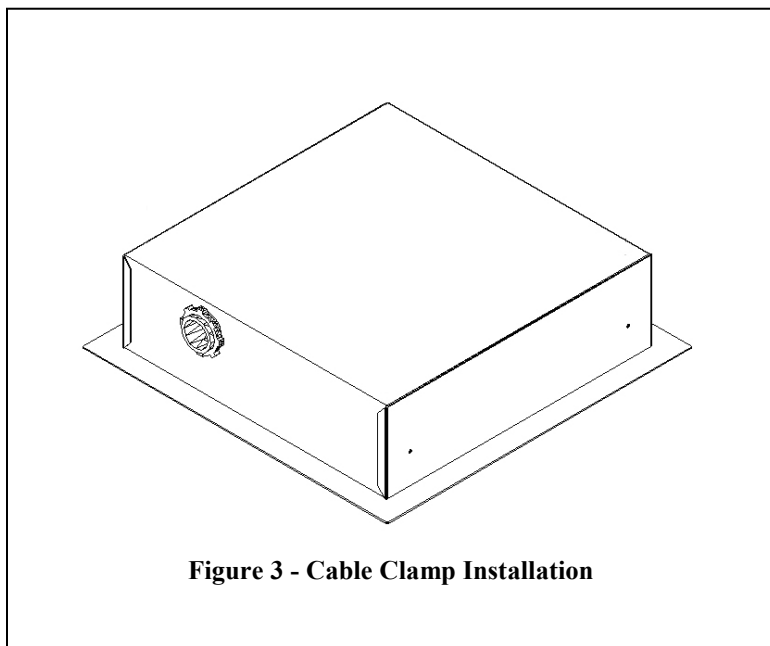
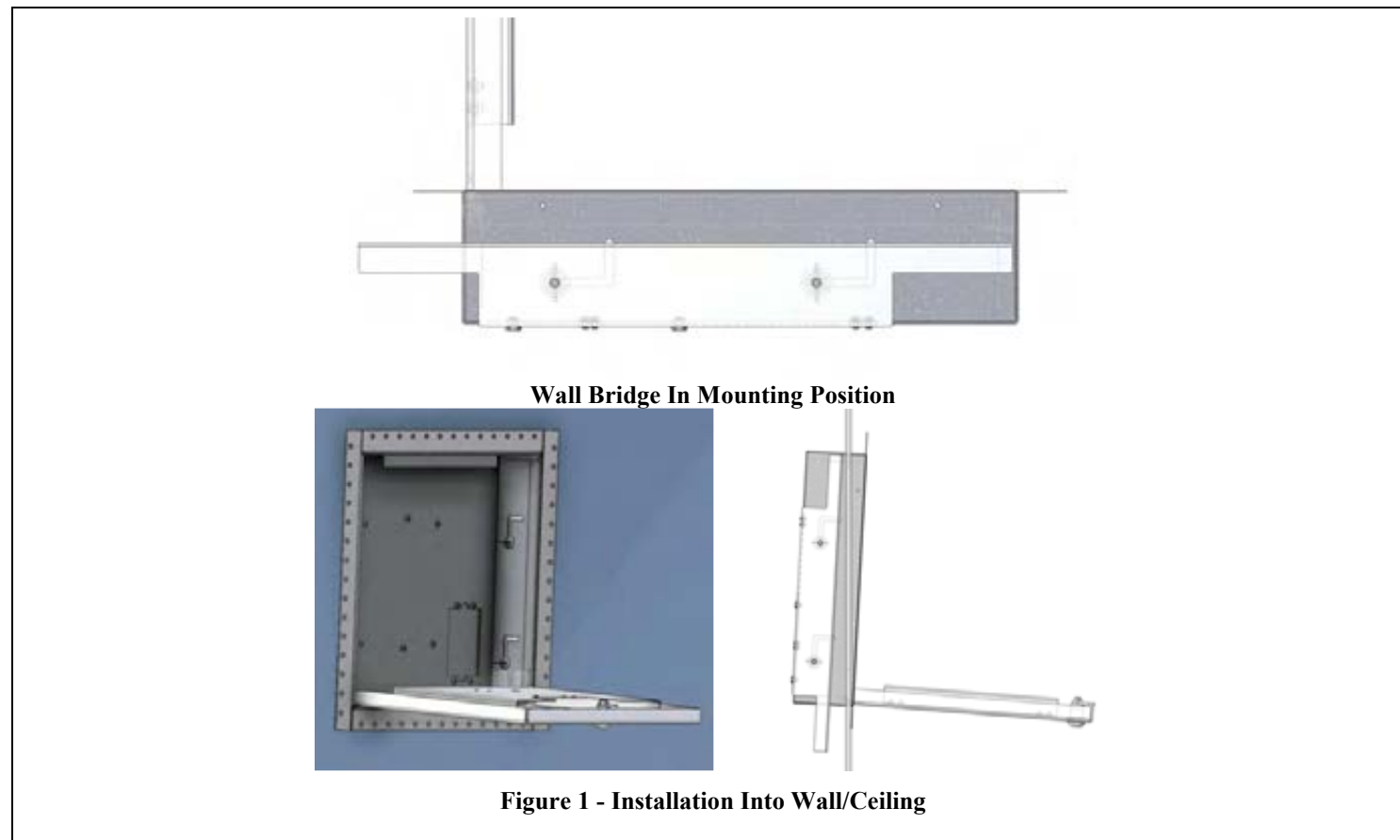

Figure 3 - Cable Clamp Installation



Wall Bridge In Mounting Position

Figure 1 - Installation Into Wall/Ceiling

Step 4 – Once the enclosure is flush with the wall or ceiling, slide the wall bridges in the L-slot, and draw the bridges against the wall. Tighten the wing nuts one side at a time (Figure 4). At this point, the enclosure is ready to be "mudded" into the wall. Additional material may be needed.

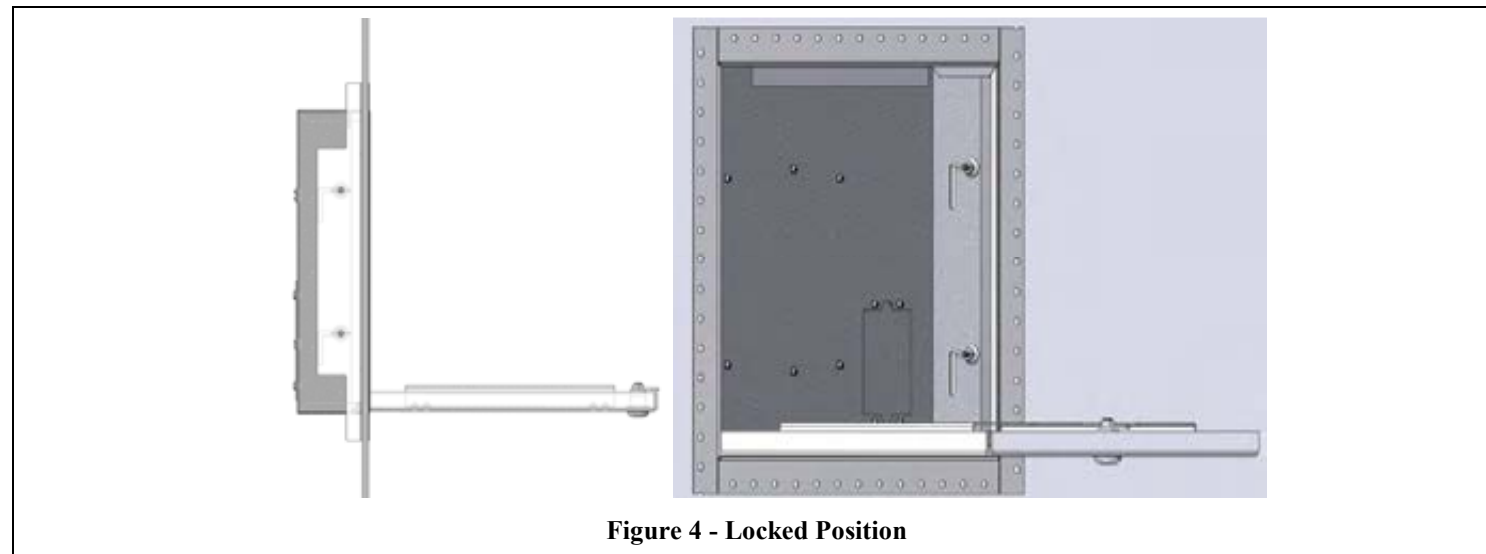

Figure 4 - Locked Position

⚠ **IMPORTANT** - This is an important safety feature that could prevent human injury or damage to the access point should the unit become dislodged from the wall or ceiling.

Step 5 –Unlock and open the door. Use the manufacturers T-Bar mount clip to attach the access point to the T-Bar Section on the mounting plate. An additional mounting plate provided by the manufacturer of the access point may be needed to attach the access point (Figure 5). *Data cable(s) may need to be plugged in to the access point prior to attaching to the mount. Cisco access points use Cisco AIR-AP-BRACKET-2 for 2600/3600 series access points and AIR-AP-BRACKET-1 for 1140/3500 series.*

Step 6 – Once the assembly has been installed in the wall or ceiling and secured using wall bridges, open the door and run the Ethernet cable into the enclosure through the conduit connector located on the side of the *access point* enclosure and attach to the access point prior to installing. Insert foam into the conduit connector and pull the data cable through far enough to allow attachment to the access point (8" - 10"). Tighten cable clamp around foam fire block so that there are no air gaps. Be careful not to over tighten and crush the Ethernet cable(s). Reference Figure 6.

Step 7 – Once the access point is secured and power and Ethernet are connected, lock the door. The installation is now complete.

If Placing Enclosure In A Ceiling

Step 8 – If placing enclosure into a ceiling remove the (4) screws in the corner of the backbox and thread the (4) eyebolts (included) into the backbox and lock into place using the (4) eyebolt nuts (included). Attach the hanger wires to the eyebolts and then to a permanent structure within the ceiling.

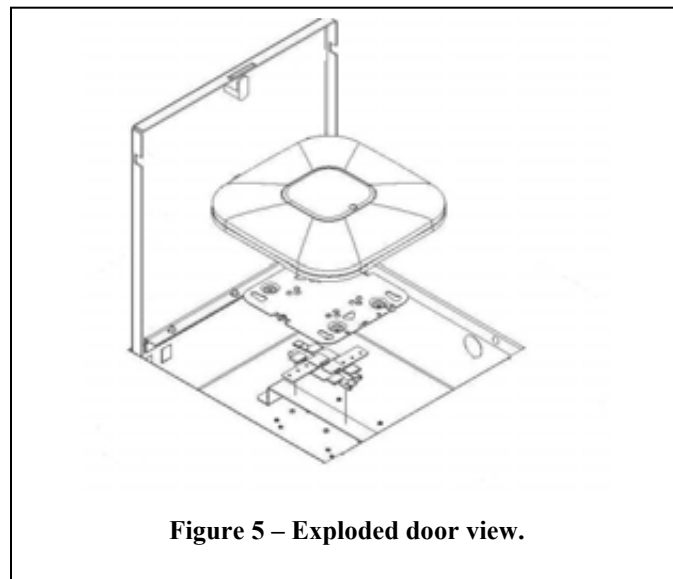

Figure 5 – Exploded door view.

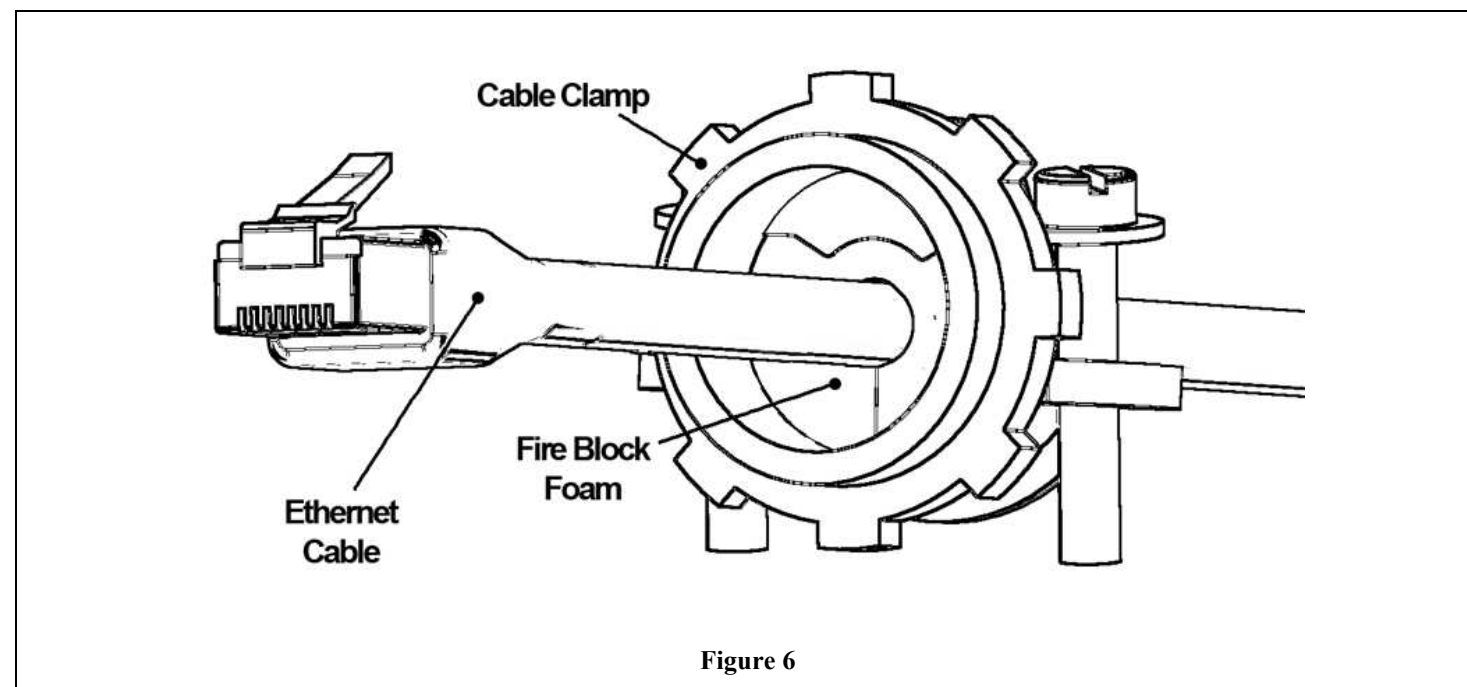
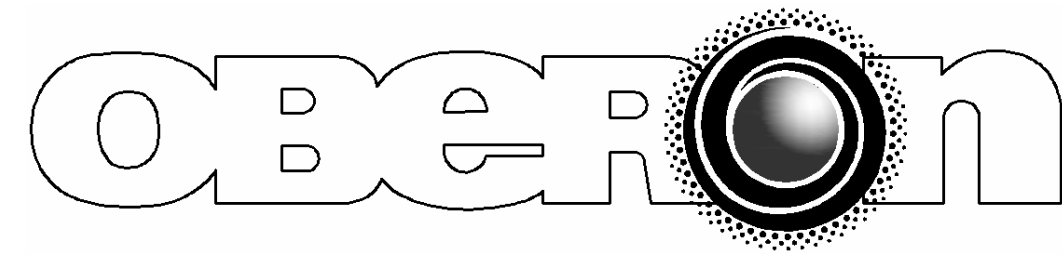

Figure 6



MODEL 1078-WA

Installation Instructions

****** WARNING ******

Please thoroughly read the product warning below before installation to provide for a safe work environment.

1. Ceiling mounted products should be installed in accordance with National Electric Code paragraphs 300.10 (Electrical Continuity of Metal Raceways and Enclosures) and 300.11 (Securing and Supporting). Independent support wires or other means must be used for the installation of this product in the ceiling. Acoustical, suspended, false, drop and concealed spline ceiling grid work is not designed to support the weight of this product. Oberon's ceiling mounted products have four support wire tabs on the back box. These tabs shall be used for supporting the product with independent support wires, wire rope, threaded rod, or other secure support means of adequate gauge and fire resistance.
2. When closing the enclosure access door, be sure that the cam lock is completely engaged to prevent the access door from accidentally swinging open.
3. When opening the enclosure door, be sure to support the door to prevent the door from accidentally falling open.
4. This enclosure has a maximum operating ambient of 55° C (131° F), the temperature within the enclosure may not exceed this temperature, depending on power dissipation within enclosure.
5. A minimum air clearance of 1" between the housing of the access point and the enclosure side walls must be maintained for the safe operation of the equipment.
6. This product is intended to be installed by trained personnel.
7. Only Listed ITE products and Listed AC Receptacles shall be installed within the enclosure.
8. This product is to be repaired by personnel trained by the manufacturer or returned to the manufacturer for repair or replacement.
9. Maximum weight to be installed in the unit is 25 lbs.
10. All knockouts, openings, and holes shall be sealed with a plug constructed of metal, or a non-metal material that complies with UL 2043 or UL 1479.
11. All unused mounting holes should be sealed with tape or other material that complies with UL 1479.
12. If AC power is used inside the enclosure, connect the ground wire to the green ground screw located near the knockout in the backbox.