

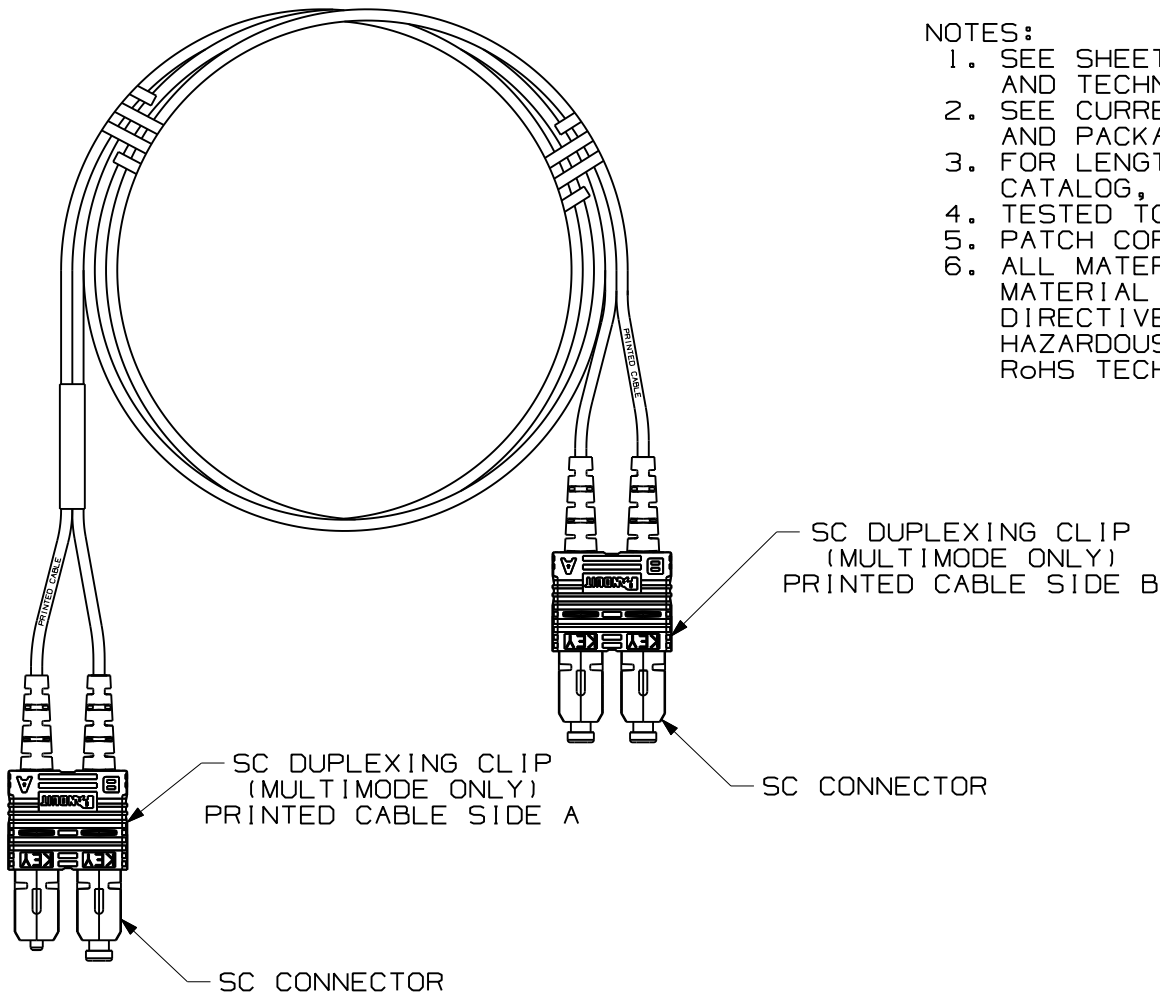

THIS COPY IS PROVIDED ON A RESTRICTED BASIS AND IS NOT TO BE USED IN ANY WAY DETRIMENTAL TO THE INTERESTS OF PANDUIT CORP.



NOTES:

1. SEE SHEETS 2, 3 & 4 FOR PRODUCT DESCRIPTIONS AND TECHNICAL SPECIFICATIONS.
2. SEE CURRENT CATALOG FOR PATCH CORD LENGTHS AND PACKAGE QUANTITIES.
3. FOR LENGTHS OTHER THAN THOSE LISTED IN CATALOG, CONTACT YOUR PANDUIT SALES PERSON.
4. TESTED TO EIA/TIA 568-B.3.
5. PATCH CORD ROUTING CONFIGURATION A TO B.
6. ALL MATERIALS AND COMPONENTS USED MEET THE MATERIAL RESTRICTIONS OF RoHS, (EUROPEAN DIRECTIVE 2002/95/EC ON THE RESTRICTION OF HAZARDOUS SUBSTANCES) AS PROPOSED BY THE RoHS TECHNICAL ADAPTATION COMMITTEE.

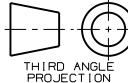
										FIBER OPTIC PATCH CORD DUPLEX SC TO SC CONFIGURATION CUSTOMER DRAWING					
										 <b>PANDUIT</b> ™ CORP. TINLEY PARK, ILL 60477					
										 THIRD ANGLE PROJECTION		ALL DIMENSIONS ARE GIVEN IN INCHES UNLESS OTHERWISE SPECIFIED. DIMENSIONAL TOLERANCES ARE: (.X) ±.03   (.XXX) ±.010   (.3) ±.010   ANGLES		DRAWING FILENAME M02779BA_DC/00B SCALE NONE	
										DRAWN BY MC		REVIEW DRAWING NUMBERS		PART NO. SEE SHEET 2, 3 & 4	
										DATE 04-27-07		DRAWING NO. 02779-09		SIZE A	
										CHK'D RAF		SHEET 1 OF 4			
01	09-09-09	EFK		RELEASED TO PRODUCTION	02779-09										
REV	DATE	BY	CHK	DESCRIPTION	ECN	R	CUST	SUP	OTH						

THIS COPY IS PROVIDED ON A RESTRICTED BASIS AND IS NOT TO BE USED IN ANY WAY DETRIMENTAL TO THE INTERESTS OF PANDUIT CORP.

DUPLEX SC TO SC FIBER OPTIC PATCH CORD							
PANDUIT PART NO.	CABLE				SC CONNECTOR		
	RATING	FIBER TYPE	COUNT	COLOR	MAX. IL	MIN. RL	BOOT COLOR
F5D3-3M*Y	RISER (OFNR)	50/125um	DUPLEX 3.0mm ZIPCORD	ORANGE	0.25dB	20dB	BLACK
F6D3-3M*Y		62.5/125um					ELECTRIC IVORY
FXD3-3M*Y		10GbE OM3		AQUA	0.25dB	26dB	AQUA
FXOD3-3M*		OPTIMIZED 10GbE OM3			0.15dB	26dB	
FZD3-3M*		10GbE OM4		AQUA	0.25dB	26dB	AQUA
FZOD3-3M*		OPTIMIZED 10GbE OM4			0.15dB	26dB	
F9D3-3M*Y		9/125um OS1		YELLOW	0.50dB	55dB	BLUE

\* - DENOTES PATCH CORD LENGTH, WHERE M = METERS AND F = FEET

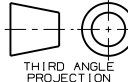
REV	DATE	BY	CHK	DESCRIPTION	ECN	R	CUST	SUP	OTH	FIBER OPTIC PATCH CORD DUPLEX SC TO SC CONFIGURATION CUSTOMER DRAWING			
										 <b>PANDUIT</b> ™ CORP. TINLEY PARK, ILL 60477	ALL DIMENSIONS ARE GIVEN IN INCHES UNLESS OTHERWISE SPECIFIED. DIMENSIONAL TOLERANCES ARE: (.X) ±.03   (.XXX) ±.010   (.3) ±.010   ANGLES		DRAWING FILENAME M02779BA_DC/00B
											 THIRD ANGLE PROJECTION	SCALE NONE	PART NO. SEE SHEET 2, 3 & 4
01	09-09-09	EFK		RELEASED TO PRODUCTION	02779-09					DRAWN BY MC DATE 04-27-07 CHK'D RAF	REVIEW DRAWING NUMBERS	DRAWING NO. 02779-09 SHEET 2 OF 4	SIZE A

THIS COPY IS PROVIDED ON A RESTRICTED BASIS AND IS NOT TO BE USED IN ANY WAY DETRIMENTAL TO THE INTERESTS OF PANDUIT CORP.

DUPLEX SC TO SC FIBER OPTIC PATCH CORD							
PANDUIT PART NO.	CABLE				SC CONNECTOR		
	RATING	FIBER TYPE	COUNT	COLOR	MAX. IL	MIN.RL	BOOT COLOR
F5PD3-3M*	PLENUM (OFNP)	50/125um	DUPLEX 3.0mm ZIPCORD	ORANGE	0.25dB	20dB	BLACK
F6PD3-3M*		62.5/125um					ELECTRIC IVORY
FXP3-3M*		10GbE OM3		AQUA	0.25dB	26dB	AQUA
FXOPD3-3M*		OPTIMIZED 10GbE OM3			0.15dB	26dB	
FZPD3-3M*		10GbE OM4		AQUA	0.25dB	26dB	AQUA
FZOPD3-3M*		OPTIMIZED 10GbE OM4			0.15dB	26dB	
F9PD3-3M*		9/125um OS1		YELLOW	0.50dB	55dB	BLUE

\* - DENOTES PATCH CORD LENGTH, WHERE M = METERS AND F = FEET

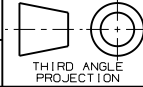
										FIBER OPTIC PATCH CORD DUPLEX SC TO SC CONFIGURATION CUSTOMER DRAWING					
										 <b>PANDUIT</b> ™ CORP. TINLEY PARK, ILL 60477					
										 THIRD ANGLE PROJECTION		ALL DIMENSIONS ARE GIVEN IN INCHES UNLESS OTHERWISE SPECIFIED. DIMENSIONAL TOLERANCES ARE: (.X) ±.03   (.XXX) ±.010   (0.3) ±.005   ANGLES		DRAWING FILENAME <b>M02779BA_DC/00B</b>	
										DRAWN BY MC		REVIEW DRAWING NUMBERS		PART NO. <b>SEE SHEET 2, 3 &amp; 4</b>	
										DATE 04-27-07		DRAWING NO. 02779-09		SIZE <b>A</b>	
01	09-09-09	EFK		RELEASED TO PRODUCTION	02779-09					CHK'D	RAF	SHEET 3 OF 4			
REV	DATE	BY	CHK	DESCRIPTION	ECN	R	CUST	SUP	OTH						

THIS COPY IS PROVIDED ON A RESTRICTED BASIS AND IS NOT TO BE USED IN ANY WAY DETRIMENTAL TO THE INTERESTS OF PANDUIT CORP.

DUPLEX SC TO SC FIBER OPTIC PATCH CORD							
PANDUIT PART NO.	CABLE				SC CONNECTOR		
	RATING	FIBER TYPE	COUNT	COLOR	MAX. IL	MIN. RL	BOOT COLOR
F5LD3-3M*	LOW SMOKE ZERO HALOGEN (LSZH) IEC	50/125um	DUPLEX 3.0mm ZIPCORD	ORANGE	0.25dB	20dB	BLACK
F6LD3-3M*		62.5/125um					ELECTRIC IVORY
FXLD3-3M*		10GbE OM3		AQUA	0.25dB	26dB	AQUA
FXOLD3-3M*		OPTIMIZED 10GbE OM3			0.15dB	26dB	
FZLD3-3M*		10GbE OM4		AQUA	0.25dB	26dB	AQUA
FZOLD3-3M*		OPTIMIZED 10GbE OM4			0.15dB	26dB	
F9LD3-3M*		9/125um OS1		YELLOW	0.50dB	55dB	BLUE

\* - DENOTES PATCH CORD LENGTH, WHERE M = METERS AND F = FEET

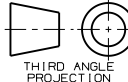
										FIBER OPTIC PATCH CORD DUPLEX SC TO SC CONFIGURATION CUSTOMER DRAWING					
										 <b>PANDUIT</b> ™ CORP. TINLEY PARK, ILL 60477					
										 THIRD ANGLE PROJECTION		<small>ALL DIMENSIONS ARE GIVEN IN INCHES UNLESS OTHERWISE SPECIFIED.</small> <small>DIMENSIONAL TOLERANCES ARE:</small> (.X) ±.03   (.XXX) ±.010   (.3) ±.008   ANGLES		<small>DRAWING FILENAME</small> M02779BA_DC/00B  <small>SCALE</small> NONE	
										<small>DRAWN BY</small> MC  <small>DATE</small> 04-27-07  <small>CHK'D</small> RAF		<small>REVIEW DRAWING NUMBERS</small>   <small>PART NO.</small> SEE SHEET 2, 3 & 4  <small>DRAWING NO.</small> 02779-09 SHEET 4 OF 4  <small>SIZE</small> A			
01	09-09-09	EFK		RELEASED TO PRODUCTION	02779-09										
REV	DATE	BY	CHK	DESCRIPTION	ECN	R	CUST	SUP	OTH						