

1 Remove 3" (76.2mm) of cable jacket and untwist pairs.

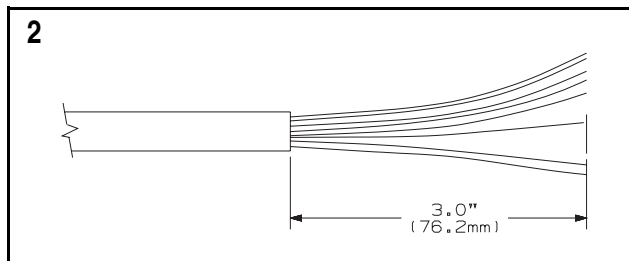

2 Straighten conductors and arrange in proper color sequence.

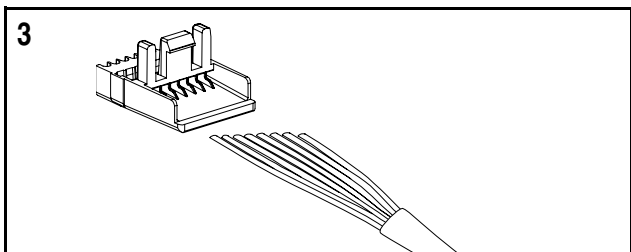

3 Cut conductors on an angle and insert into cap.

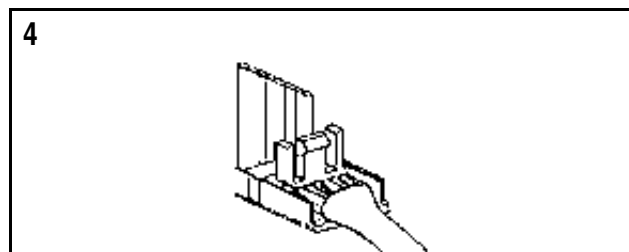

4 Pull conductors until outer jacket is inside cap. Bend up 90°.

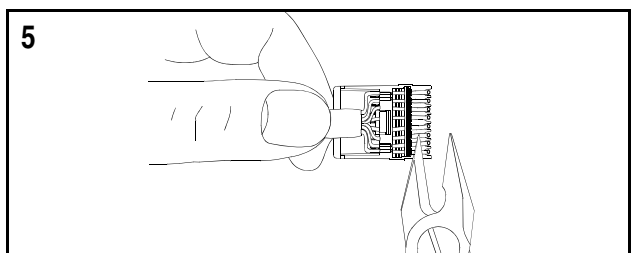

5 Trim conductors flush with cap using wire snipping tool (CWST).
NOTE: Cable jacket is inside the cover.

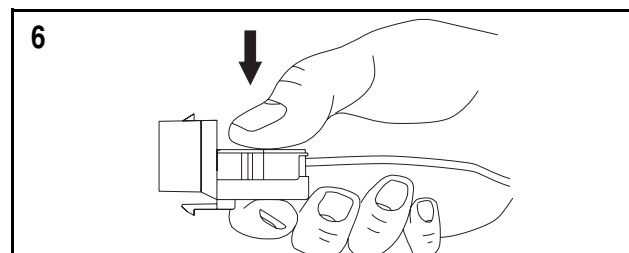

6 Snap cap squarely on housing until it clicks.

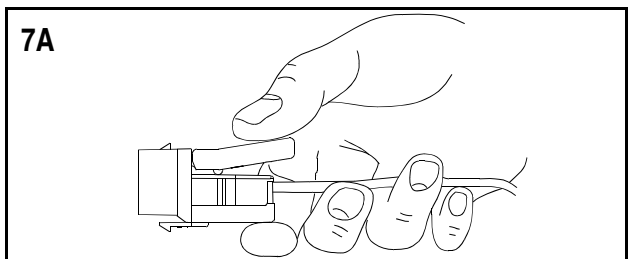

7A Apply pressure to cap until it clicks again. Cap must be flush on housing.

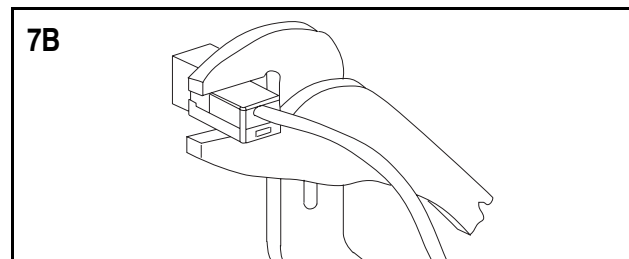

7B Use Snap Tool (7A) or standard Slip Lock Pliers (7B).

Termination Cap Removal Instructions

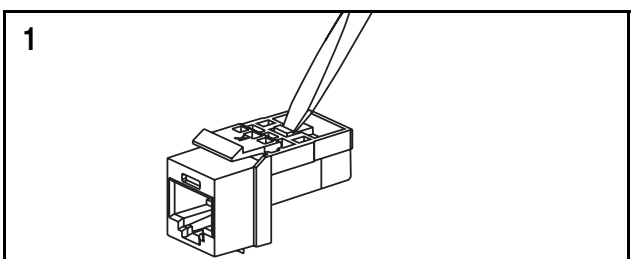

1 Push forward and down against latch at end of guide ramp until cap releases.

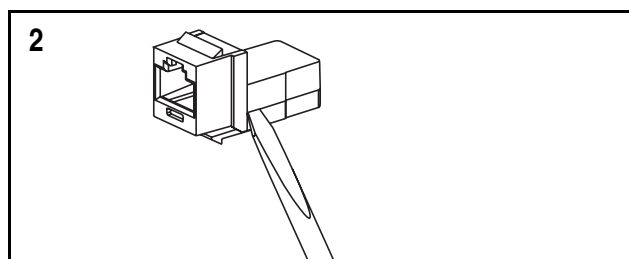

2 Slide screwdriver under cap to separate from housing.

--- FOR USE IN KEYSTONE STYLE OUTLETS AND PATCH PANELS ONLY ---
--- OVER FOR KEYSTONE STYLE PANEL OPENING REQUIREMENTS ---

** Denotes jack module color code.

For Technical Support: www.panduit.com/resources/install_maintain.asp

--- CATEGORY 5/5E NK588/5E88 SERIES WIRING SEQUENCES ---

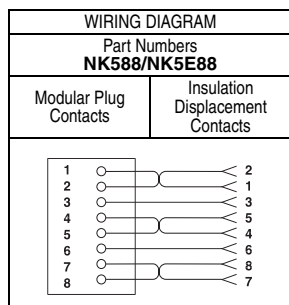

“Category 5/5E” Keystone Style Jack Modules Color-Coded Wire Positions

T568A, ISDN			T568B, AT&T 258A, WECO		
2	GREEN	R3	2	ORANGE	R2
1	WHITE/GREEN	T3	1	WHITE/ORANGE	T2
3	WHITE/ORANGE	T2	3	WHITE/GREEN	T3
5	WHITE/BLUE	T1	5	WHITE/BLUE	T1
4	BLUE	R1	4	BLUE	R1
6	ORANGE	R2	6	GREEN	R3
8	BROWN	R4	8	BROWN	R4
7	WHITE/BROWN	T4	7	WHITE/BROWN	T4

Refer to catalog for a listing of color-coded NETKEY Keystone Style Jack Modules.

--- CATEGORY 3 NK366/388 SERIES WIRING SEQUENCES ---

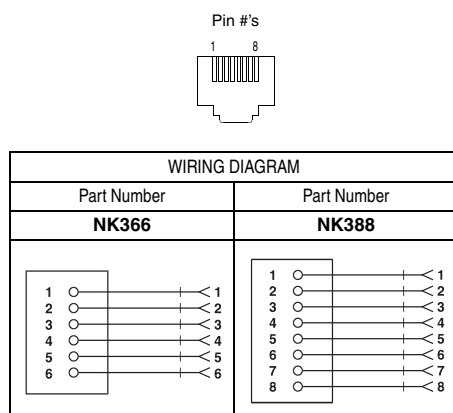

“Category 3” Keystone Style Jack Modules Color-Coded Wire Positions

10 Base-T	EIA/TIA 568A, ISDN	USOC 4-Wire (8 Pin Jack)	RJ45, USOC 8-Wire
1 WHT/GRN T3	1 WHT/GRN T3	1 NC	1 BRN R4
2 GRN/WHT R3	2 GRN R3	2 NC	2 WHT/GRN T3
3 WHT/BRN T4	3 WHT/ORG T2	3 WHT/ORG T2	3 WHT/ORG T2
4 NC	4 BLU R1	4 BLU/WHT R1	4 BLU R1
5 NC	5 WHT/BLU T1	5 WHT/BLU T1	5 WHT/BLU T1
6 BRN/WHT R4	6 ORG R2	6 ORG.WHT R2	6 ORG R2
7 NC	7 WHT/BRN T4	7 NC	7 GRN R3
8 NC	8 BRN R4	8 NC	8 WHT/BRN T4

EIA/TIA 568B, AT&T 258A, WECO	USOC 4-wire in 6 pin	USOC 6-Wire (8 Pin Jack)	USOC, RJ11/RJ25
1 WHT/ORG T2	1	1 NC	1 WHT/GRN T3
2 ORG R2	2 WHT/ORG T2	2 WHT/GRN T3	2 WHT/ORG T2
3 WHT/GRN T3	3 BLU R1	3 WHT/ORG T2	3 BLU R1
4 BLU R1	4 WHT/BLU T1	4 BLU R1	4 WHT/BLU T1
5 WHT/BLU T1	5 ORG R2	5 WHT/BLU T1	5 ORG R2
6 GRN R3	6	6 ORG R2	6 GRN R3
7 WHT/BRN T4		7 GRN R3	
8 BRN R4		8 NC	

Refer to catalog for a listing of color-coded NETKEY Keystone Style Jack Modules.

--- KEYSTONE STYLE PANEL OPENING REQUIREMENTS ---

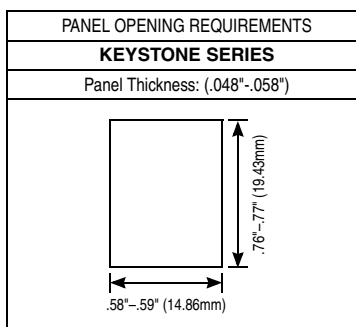

Notes:

- For specified performance, follow TIA/EIA 568A installation guidelines and use equivalent or higher Category twisted pair cable.
- Keystone Style Jack Modules can terminate PVC or Plenum rated 22-24 AWG solid or stranded IWC cable with 0.048 inch (1.2mm) maximum insulated conductor outside diameter.
- Keystone Style Jack Modules may be reterminated a minimum of 10 times.
- For technical and performance data, refer to catalog or consult PANDUIT Technical Support.

As with all Wiring Accessories, the following statements apply:

- Never install communications wiring during a lightning storm.
- Never install communications wiring in wet locations unless the jack is specifically designed for use in wet locations.
- Never touch uninsulated communications wiring or terminals unless the communication line has been disconnected at the network interface.
- Use caution when installing or modifying communication wiring.

For Instructions in Local Languages and Technical Support:

www.panduit.com/resources/install_maintain.asp



www.panduit.com

E-mail: cs@panduit.com

Fax: 866-449-1702