



Office Furniture Raceway System



PANWAY® OFFICE FURNITURE RACEWAY



PANDUIT is a Solutions Enabler Partner for IP Communications within the Cisco Technology Developer Program.

*Extend the life of your
office furniture investment with...*

PAN-WAY® Office Furniture Raceway

- *Eliminates the need to purchase expensive furniture that incorporates internal data passages or retro-fit kits that require dismantling of furniture*
- *Is supplied with adhesive backing for fast and easy installation*
- *Installs on top of existing furniture partitions, minimizing occupant disturbance*
- *Easily accommodates frequent relocation of personnel within the facility*
- *Is the only “universal – off the shelf” modular furniture raceway system intended for routing and terminating data cabling on furniture partitions*
- *Can be installed by any knowledgeable contractor or facilities personnel*
- *Patented (innovative) corner termination option utilizes the typically unused area of the cubical, saving valuable workspace*



- *Four popular colors to blend with most office furniture systems*



ENTER

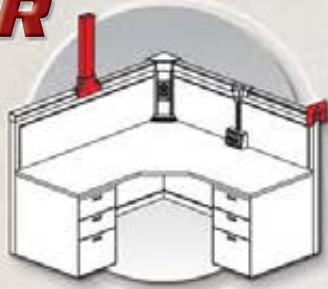

ROUTE



TERMINATE

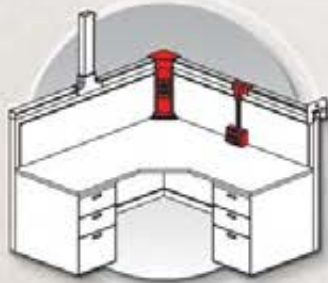

Office Furniture Raceway Roadmap



NOTE: Office Furniture Raceway is designed to blend with its environment. Shown in White on Office Slate furniture for illustration purposes only.

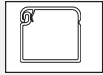

1 OFR20**6 — Office Furniture Raceway (page 7)



A OFCR70**6 — Corner Raceway Base (page 7)

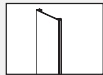

B OFCRC70**6 — Corner Raceway Cover (page 7)

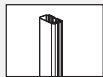

C OFVR5**6 — Vertical Raceway (page 8)

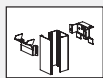

D OFR20CP**8 — Communication Pole (page 8)

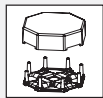

E OFR20OFCR70**4 — Four Cubicle Drop Fitting (page 8)

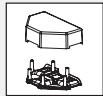

F OFR20OFCR70**2 — Two Cubicle Drop Fitting (page 8)

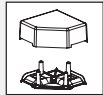

G OFR20OFCR70**1 — One Cubicle Drop Fitting (page 8)

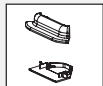

H OFCR70EC** — End Cap Fitting (page 9)

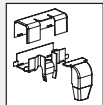

J OFR20SO** — Spill Over Fitting (page 9)

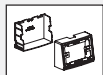

K OFR20DMB** — Desk Mount Box (page 9)

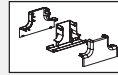

L OFR20MPT** — Mid Panel Tee Fitting (page 9)



M OFR20WE** — Wall Entrance Fitting (page 9)

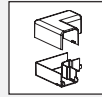

N OFR20RA** — Right Angle Fitting (page 10)

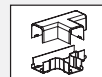

O OFR20T** — Tee Fitting (page 10)

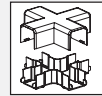

P OFR20CR** — Cross Fitting (page 10)

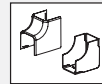

Q OFR20IC** — Inside Corner Fitting (page 10)

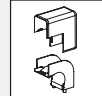

R OFR20OC** — Outside Corner Fitting (page 10)



S OFR20CC** — Coupler Fitting (page 10)

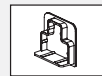

T OFR20EC** — End Cap Fitting (page 10)

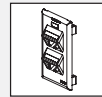

U OF70FV4** — Vertical Sloped Communication Snap-on Faceplate (page 11)



V OF70FH4** — Horizontal Sloped Communication Snap-on Faceplate (page 11)

Office Furniture Exploded Views

Exploded view 1

| | Components Required | See page |
|----|--|----------|
| A. | OFR20OFCR70**4 = Four Cubicle Drop Fitting. | 8 |
| B. | OFCR70**6 = Corner Raceway Base. | 7 |
| C. | OFCR70EC = End Cap Fitting. | 9 |
| D. | OF70FV4 = Vertical Sloped Communication Snap-on Faceplate. | 11 |
| E. | MINI-COM® Modules. ‡Alternate Connectivity | — |
| F. | OFCRC70**6 = Corner Raceway Cover. | 7 |

‡ To utilize alternative connectivity solutions with a NEMA standard 70mm faceplate, T70SDB-X (device bracket) must be used. See page 11.

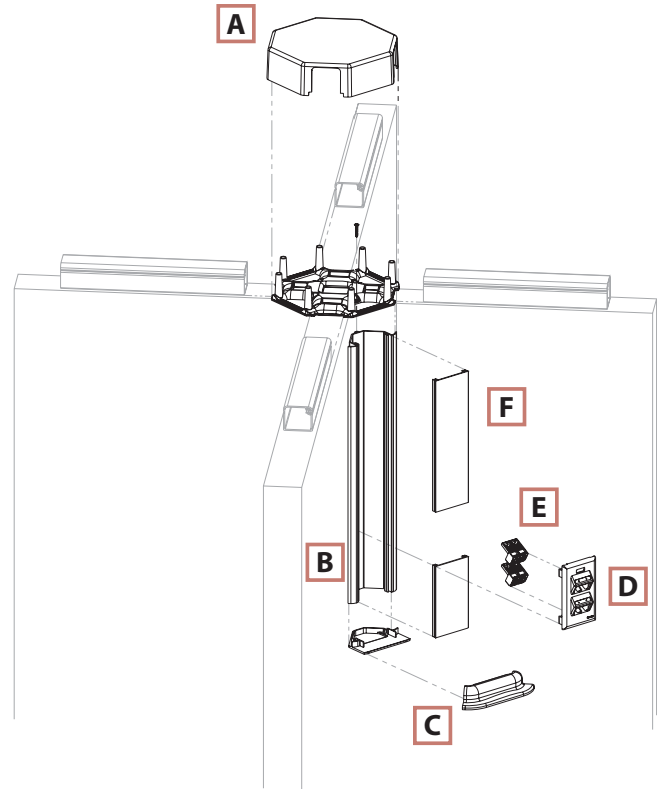

Exploded view 2

| | Components Required | See page |
|----|--|----------|
| A. | OFR20SO** = Spill Over Fitting. | 9 |
| B. | OFVR5**6 = Vertical Raceway. | 8 |
| C. | OFR20DMB = Desk Mount Box. | 9 |
| D. | MINI-COM® Modules. ‡‡Alternate Connectivity | — |
| E. | OF70FH4** = Horizontal Sloped Communication Snap-on Faceplate. | 11 |

‡‡ To utilize alternative connectivity solutions with a NEMA standard 70mm faceplate, screw mount faceplate directly to desk mount box (OFR20DMB**).

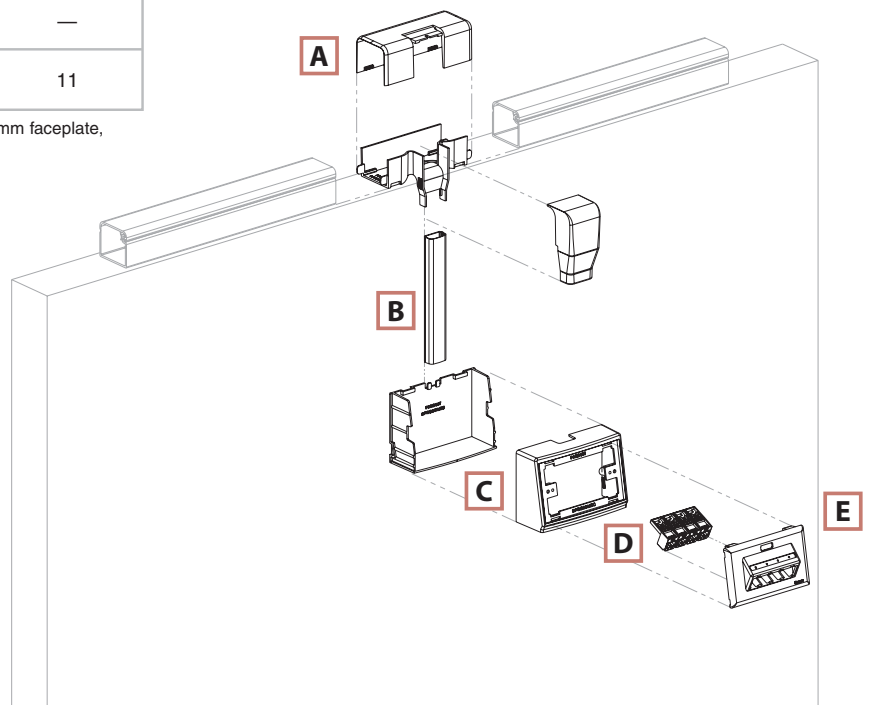

PAN-WAY® Office Furniture Raceway System

- UL listed in accordance with UL-5C requirements for Class 2 Communication Cable Management Systems
- Maintains bend radius control throughout the entire Office Furniture Raceway system as required by TIA/EIA 568-B and 569-B
- Faceplates are compliant with the labeling requirements of the TIA/EIA-606-A standard
- Robust design and tamper resistant closure increases product stability and prevents damage to cabling during and after installation
- Product supplied with adhesive backing for fast and easy installation
- Creates a virtually invisible solution for routing data cables on panels from all common manufacturers with a top cap width between 1.88" and 2.30"

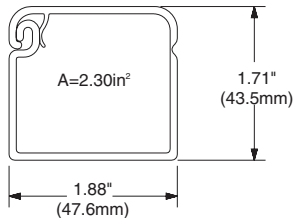

OFR20OB6



Office Beige (OB)



Office Slate (OS)



Office Gray (OG)



Medium Tone (MT)

| Part Number | Part Description | Raceway Size | Color* | Std. Pkg. Qty. | Std. Ctn. Qty. |
|-----------------|--|---------------|--------------|----------------|----------------|
| OFR20OB6 | Office Furniture Raceway. One piece single channel low voltage raceway with adhesive tape backing for data cable routing along top of modular furniture partitions. Available in 6' lengths. | 1.88" x 1.71" | Office Beige | 6 | 48 |
| OFR20OB8 | Office Furniture Raceway. One piece single channel low voltage raceway with adhesive tape backing for data cable routing along top of modular furniture partitions. Available in 8' lengths. | 1.88" x 1.71" | Office Beige | 8 | 64 |

*For other colors, replace OB (Office Beige) with OS (Office Slate), OG (Office Gray) or MT (Medium Tone). Order number of feet required in multiples of standard length increments.

PAN-WAY® Office Furniture Raceway Fittings

- Office Furniture Raceway fittings have been designed to maintain the TIA/EIA required 1" minimum bend radius for high performance copper and fiber optic cabling systems



OFCR70OB6



OFCRC70OB6

| Part Number | Part Description | Color | Std. Pkg. Qty. | Std. Ctn. Qty. |
|-------------------|---|--------------|----------------|----------------|
| OFCR70OB6 | Office Furniture Corner Raceway Base. Used to terminate low voltage data cabling in the corner at the intersection of modular office furniture panels. Accepts 70mm standard faceplates. Available in 6' lengths. | Office Beige | 6 | 48 |
| OFCRC70OB6 | Office Furniture Corner Raceway Cover. Available in 6' lengths. | Office Beige | 6 | 48 |

*For other colors, replace OB (Office Beige) with OS (Office Slate), OG (Office Gray) or MT (Medium Tone). Order number of feet required in multiples of standard length increments.

Order number of pieces required, in multiples of Standard Package Quantity.

PAN-WAY® Office Furniture Raceway Fittings (continued)



OFVR5OB6

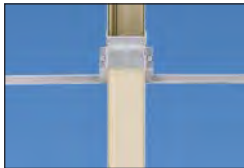

OFR20CPOB8



OFR20OFCR70OB4



OFR20OFCR70OB2



OFR20OFCR70OB1



OFR20OFCR70OB1P



OFR20OFCR70OB2P

| Part Number | Part Description | Color | Std. Pkg. Qty. | Std. Ctn. Qty. |
|------------------------|--|--------------|----------------|----------------|
| OFVR5OB6 | Office Furniture Vertical Raceway. One piece single channel raceway used to connect OFR20**6 to desk mount box (OFR20DMB**) and must be used with OFR20SO** or OFR20DSO**. Available in 6' lengths. | Office Beige | 6 | 120 |
| OFR20CPOB8 | Communication Pole. Allows for data cable entry into Office Furniture Raceway from suspended ceiling. 8' pole allows maximum 7' distance from top of furniture partition to ceiling. Must be used with OFR20MPT**. NOTE: Not intended for use at intersection of furniture panels. | Office Beige | 1 | — |
| OFR20OFCR70OB4 | Four Cubicle Drop Fitting. Allows the transition from Office Furniture Raceway run horizontally along partition wall to Office Furniture Corner Raceway mounted vertically in four cubicles at the intersection of partitions. Fitting maintains 1" minimum bend radius of cabling. Supplied with adhesive tape. | Office Beige | 1 | 10 |
| OFR20OFCR70OB2 | Two Cubicle Drop Fitting. Allows the transition from Office Furniture Raceway run horizontally along partition wall to Office Furniture Corner Raceway mounted vertically in two cubicles at the intersection of partitions. Fitting maintains 1" minimum bend radius of cabling. Supplied with adhesive tape. | Office Beige | 1 | 10 |
| OFR20OFCR70OB1 | One Cubicle Drop Fitting. Allows the transition from Office Furniture Raceway run horizontally along partition wall to Office Furniture Corner Raceway mounted vertically in one cubicle at the intersection of partitions. Fitting maintains 1" minimum bend radius of cabling. Supplied with adhesive tape. | Office Beige | 1 | 10 |
| OFR20OFCR70OB1P | One Cubicle Drop Bypass Fitting. Allows the transition from Office Furniture Raceway run horizontally along partition wall, around existing furniture pole, to Office Furniture Corner Raceway mounted vertically in one cubicle at the intersection of partitions. Fitting maintains 1" minimum bend radius of cabling. Supplied with adhesive tape. | Office Beige | 1 | 10 |
| OFR20OFCR70OB2P | Two Cubicle Drop Bypass Fitting. Allows the transition from Office Furniture Raceway run horizontally along partition wall, around existing furniture pole, to Office Furniture Corner Raceway mounted vertically in two cubicles at the intersection of partitions. Fitting maintains 1" minimum bend radius of cabling. Supplied with adhesive tape. | Office Beige | 1 | 10 |

*For other colors, replace OB (Office Beige) with OS (Office Slate), OG (Office Gray) or MT (Medium Tone). Order number of feet required in multiples of standard length increments.

Order number of pieces required, in multiples of Standard Package Quantity.

PAN-WAY® Office Furniture Raceway Fittings (continued)



OFR20OFCR70OB4P



OFCR70ECOB



OFR20SOOB



OFR20DSOOB



OFR20DMBOB



OFR20MPTOB



OFR20WEOB

| Part Number | Part Description | Color | Std. Pkg. Qty. | Std. Ctn. Qty. |
|------------------------|--|--------------|----------------|----------------|
| OFR20OFCR70OB4P | Four Cubicle Drop Bypass Fitting. Allows the transition from Office Furniture Raceway run horizontally along partition wall, around existing furniture pole, to Office Furniture Corner Raceway mounted vertically in four cubicles at the intersection of partitions. Fitting maintains 1" minimum bend radius of cabling. Supplied with adhesive tape. | Office Beige | 1 | 10 |
| OFCR70ECOB | Corner Raceway End Cap Fitting. Opening allows cord passage through fitting such as monitor and keyboard cables. Supplied with adhesive tape. | Office Beige | 1 | 10 |
| OFR20SOOB | Spill-over Fitting. Allows transition from Office Furniture Raceway run horizontally along partition wall to Office Furniture Vertical Raceway in one location. Adjustable fitting maintains 1" minimum bend radius of cabling and works with various panel widths between 1.88" - 2.30". Supplied with adhesive tape. | Office Beige | 1 | 10 |
| OFR20DSOOB | Double Spill-Over Fitting. Fitting is used to spill over both sides of the furniture partitions at the same location. Incorporates a built-in, yet removable end cap that eliminates the need for additional raceway and fittings to terminate the pathway. | Office Beige | 1 | 10 |
| OFR20DMBOB | Desk Mount Box. Box accepts Office Furniture Snap-on Faceplates as well as 70mm NEMA standard screw-on faceplates. Designed for use with OFVR5**6 raceway and OFR20SO**, OFR20DSO** spill over fittings. Supplied with adhesive tape. | Office Beige | 1 | 10 |
| OFR20MPTOB | Mid-panel Tee Fitting. Used to connect communication pole to Office Furniture Raceway run horizontally along partition wall. Supplied with adhesive tape. NOTE: Not intended for use at intersection of furniture panels. | Office Beige | 1 | 10 |
| OFR20WEOB | Wall Entrance Fitting. Allows entry from wall to Office Furniture Raceway run horizontally along partition walls. Fitting includes bend radius protection and trim plate to cover wall opening. Requires minimum wall opening of 4.5"W x 3.0"H. Supplied with adhesive tape. | Office Beige | 1 | 10 |

*For other colors, replace OB (Office Beige) with OS (Office Slate), OG (Office Gray) or MT (Medium Tone).

Order number of pieces required, in multiples of Standard Package Quantity.

PAN-WAY® Office Furniture Raceway Fittings (continued)



OFR20RAOB



OFR20TOB



OFR20CROB

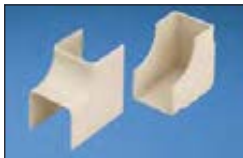

OFR20ICOB



OFR20OCOB



OFR20CCOB-X



OFR20LCOB



OFR20ECOB

| Part Number | Part Description | Color | Std. Pkg. Qty. | Std. Ctn. Qty. |
|--------------------|--|--------------|----------------|----------------|
| OFR20RAOB | Right Angle Fitting. Used to join sections of Office Furniture Raceway at 90° flat junction. Supplied with adhesive tape. | Office Beige | 1 | 10 |
| OFR20TOB | Tee Fitting. Used to create an undivided tee junction between sections of Office Furniture Raceway. Supplied with adhesive tape. | Office Beige | 1 | 10 |
| OFR20CROB | Cross Fitting. Used to join sections of Office Furniture Raceway at four corners. Supplied with adhesive tape.. | Office Beige | 1 | 10 |
| OFR20ICOB | Inside Corner Fitting. Used to join sections of Office Furniture Raceway at inside corner. Supplied with adhesive tape. | Office Beige | 1 | 10 |
| OFR20OCOB | Outside Corner Fitting. Used to join sections of Office Furniture Raceway at outside corner. Supplied with adhesive tape. | Office Beige | 1 | 10 |
| OFR20CCOB-X | Coupler Fitting. For use with Office Furniture Raceway. | Office Beige | 10 | 100 |
| OFR20LCOB | Long Coupler Fitting. Used to bridge Office Furniture Raceway between panel sections. Can also be used to fill void left by Spill-over Fitting, when furniture partitions are reconfigured. Supplied with adhesive tape. | Office Beige | 1 | 10 |
| OFR20ECOB | End Cap Fitting. Used to terminate Office Furniture Raceway. Supplied with adhesive tape. | Office Beige | 10 | 100 |

*For other colors, replace OB (Office Beige) with OS (Office Slate), OG (Office Gray) or MT (Medium Tone).

Order number of pieces required, in multiples of Standard Package Quantity.

PAN-WAY® Office Furniture Raceway Faceplates



OF70FH2OB



OF70FV2OB



OF70FH4OB



OF70FV4OB



T70SDB-X

| Part Number | Part Description | Color | Std. Pkg. Qty. | Std. Ctn. Qty. |
|------------------|---|--------------|----------------|----------------|
| OF70FH2OB | Snap-on Single Gang Horizontal Sloped Communication Faceplate. Accepts up to two <i>PANDUIT® Mini-Com®</i> modules (not included). No additional mounting hardware required. TIA/EIA-606-A compliant.. | Office Beige | 1 | 10 |
| OF70FV2OB | Snap-on Single Gang Vertical Sloped Communication Faceplate. Accepts up to two <i>PANDUIT® Mini-Com®</i> modules (not included). No additional mounting hardware required. TIA/EIA-606-A compliant.. | Office Beige | 1 | 10 |
| OF70FH4OB | Snap-on Single Gang Horizontal Sloped Communication Faceplate. Accepts up to four <i>PANDUIT® Mini-Com®</i> modules (not included). No additional mounting hardware required. TIA/EIA-606-A compliant.. | Office Beige | 1 | 10 |
| OF70FV4OB | Snap-on Single Gang Vertical Sloped Communication Faceplate. Accepts up to four <i>PANDUIT® Mini-Com®</i> modules (not included). No additional mounting hardware required. TIA/EIA-606-A compliant.. | Office Beige | 1 | 10 |
| T70SDB-X | Standard Faceplate Bracket. Used to mount NEMA standard 70mm single gang screw-on faceplates.. | Gray | 10 | 0 |

*For other colors, replace OB (Office Beige) with OS (Office Slate), OG (Office Gray) or MT (Medium Tone). T70SDB-X available in Gray only.

Office Furniture Raceway Quick Wirefill Guide

| Fill Capacity (Data) | 40% Fill | 60% Fill |
|---|----------|----------|
| CAT5e Cable (24 AWG/UTP CM) Diameter = .217" | 24 | 37 |
| CAT6 Cable (24 AWG/UTP CM) Diameter = .250" | 18 | 28 |
| Coax Cable (RG6) Diameter = .275" | 15 | 23 |
| 2 Strand Fiber Optic Cable Diameter = .175" | 38 | 57 |

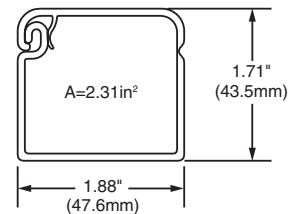

Order number of pieces required, in multiples of Standard Package Quantity.



PANDUIT Corp.
Tinley Park, Illinois 60477-3091

For more information
Visit us at www.panduit.com
Contact Customer Service by email: cs@panduit.com
or by phone: 800-777-3300



PANDUIT Europe Ltd.
London, UK
cs-emea@panduit.com
Phone: 44.20.8601.7200



PANDUIT Japan
Tokyo, Japan
cs-japan@panduit.com
Phone: 81.3.3767.7011



PANDUIT Singapore Pte. Ltd.
Republic of Singapore
cs-ap@panduit.com
Phone: 65.6379.6700



PANDUIT Latin America
Jalisco, Mexico
cs-la@panduit.com
Phone: 52.333.666.2501



PANDUIT Australia Pty. Ltd.
Victoria, Australia
cs-aus@panduit.com
Phone: 61.3.9794.9020



PANDUIT Canada
Markham, Ontario
cs-cdn@panduit.com
Phone: 800.777.3300

WORLDWIDE HEADQUARTERS

For a copy of *PANDUIT* product warranties, log on to www.panduit.com/warranty

© 2005 *PANDUIT* Corp.
ALL RIGHTS RESERVED
Printed in the U.S.A.
WW-SRCB04
10/2005