

**Disconnect
switches
Non-fusible**

General information

Selection guide

OT16F3 – OT160E3



OT16F3 OT25F3 OT40F3



OT63F3 OT80F3



OT30F3 OT60F3 OT100F3



OT160E3

Catalog number	3 pole	OT16F3	OT25F3	OT40F3	OT63F3	OT80F3	OT30F3	OT60F3	OT100F3	OT160E3
General purpose amp rating	A	16	25	40	60	80	30	60	100	125
Approvals ①										
	2 pole	N/A	N/A	N/A	N/A	N/A	N/A	N/A	N/A	UL98
	3 pole	UL508	UL508	UL508	UL508	UL508	UL98	UL98	UL98	UL98
	4 pole	UL508	UL508	UL508	UL508	UL508	UL98	UL98	UL98	UL98
Technical ratings – UL, CSA ②										
Max operating voltage	V	600	600	600	600	600	600	600	600	600
Max horsepower rating										
Three phase										
240V	HP	5	7.5	10	15	20	10	20	30	40
480V	HP	10	15	20	30	40	20	40	50	75
600V	HP	10	20	25	30	40	30	40	50	100
Single phase										
120V	HP	1	1.5	2	2	2	2	3	5	7.5
240V	HP	2	3	5	5	5	5	7.5	15	20
Technical ratings – IEC ②										
Rated insulation and operational voltage. AC20 and DC20	V	750	750	750	750	750	750	750	750	750
Rated thermal current, I _{th}										
AC 20/DC 20 open	A	25	32	40	63	80	40	63	115	200
AC 20/DC 20 enclosed	A	25	32	40	63	80	40	63	115	160
AC 21A ≤500V	A	16	25	32	63	80	40	63	100	160
≤690V	A	16	25	32	63	80	40	63	100	160
Rated operational power AC23										
400/415V	kW	7.5	9	11	22	37	15	18.5	37	75
690V	kW	7.5	9	11	15	18.5	15	15	37	75
Physical characteristics										
Weight ③	3 pole	lb	0.24	0.24	0.24	0.59	0.59	0.79	0.79	2.42
Dimension	3 pole	H in	2.68	2.68	2.68	3.60	3.60	3.94	3.94	5.00
		W in	1.38	1.38	1.38	2.07	2.07	2.76	2.76	4.96
		D in	2.20	2.20	2.20	2.85	2.85	2.95	2.95	2.93
Accessories										
Terminal lug kit		Integral	Integral	Integral	Integral	Integral	Integral	Integral	Integral	Integral
Terminal shroud		•	•	•	•	•	•	•	•	—
Auxiliary contact		•	•	•	•	•	•	•	•	•
Shaft/handle diameter		6mm .24" x .24"	6mm .24" x .24"	6mm .24" x .24"	6mm .24" x .24"	6mm .24" x .24"	6mm .24" x .24"	6mm .24" x .24"	6mm .24" x .24"	6mm .24" x .24"
Handle UL/NEMA type										
Type 1, 3R, 12		•	•	•	•	•	•	•	•	•
Type 1, 3R, 4, 4X, 12		•	•	•	•	•	•	•	•	•
Handle type										
Selector		•	•	•	•	•	—	—	—	—
Pistol		•	•	•	•	•	•	•	•	•
Recommended pistol handle length		45 - 65mm	45 - 65mm	45 - 65mm	45 - 65mm	45 - 65mm	45 - 65mm	45 - 65mm	45 - 65mm	65 - 80mm
Maximum recommended shaft length		290mm	290mm	290mm	290mm	290mm	290mm	290mm	290mm	290mm
Conversion kits										
6 pole		•	•	•	•	•	•	•	•	•
Transfer		•	•	•	•	•	•	•	•	•
Bypass		•	•	•	•	•	•	•	•	•
Mechanical interlock		•	•	•	•	•	•	•	•	•
Electrical interlock		—	—	—	—	—	—	—	—	—

18

• = Available
— = Not available

① UL listed switches are also CSA approved.
② For complete technical information please see page 18.38 – 18.70.
③ Switch only.

General information

Selection guide

OT200 – OT600 & OETL-NF800A – OETL-NF3150

Disconnect
switches
Non-fusible

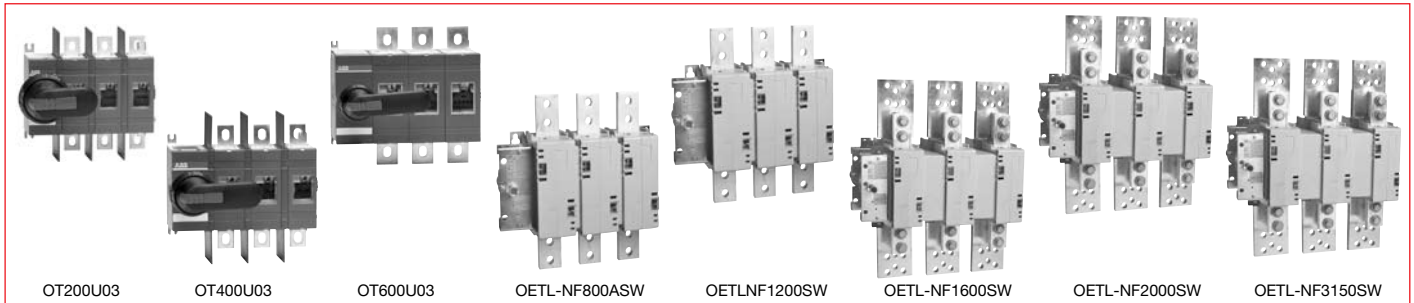

Catalog number	3 pole	OT200U03	OT400U03	OT600U03	OETL-NF800A	OETL-NF1200	OETL-NF1600	OETL-NF2000	OETL-NF3150
General purpose amp rating	A	200	400	600	800	1200	1600	2000	3150
Approvals ①	2 pole 3 pole 4 pole	N/A UL98 & IEC UL98 & IEC	N/A UL98 & IEC UL98 & IEC	UL98 & IEC UL98 & IEC UL98 & IEC	UL98 & IEC UL98 & IEC IEC	UL98 & IEC UL98 & IEC IEC	UL98 & IEC UL98 & IEC IEC	UL98 & IEC UL98 & IEC IEC	IEC IEC IEC
Technical ratings – UL, CSA ②									
Max operating voltage	V	600	600	600	600	600	600	600	600
Max horsepower rating									
Three phase									
240V	HP	75	125	200	250	—	—	—	—
480V	HP	150	250	450	500	—	—	—	—
600V	HP	200	350	500	600	—	—	—	—
Single phase									
120V	HP	—	—	—	—	—	—	—	—
240V	HP	—	—	—	—	—	—	—	—
Technical ratings – IEC ②									
Rated insulation and operational voltage, AC20 and DC20	V	1000	1000	1000	1000	1000	1000	1000	1000
Rated thermal current, I _n									
AC 20/DC 20 open	A	250	400	800	1250	1600	2500	2500	3150
AC 20/DC 20 enclosed	A	250	400	800	1250	1600	2300	2300	2600
AC 21A ≤500V	A	250	400	800	1250	1600	2500③	2500③	3150③
AC 21A ≤690V	A	250	400	800	1250	1600	2500③	2500③	3150③
Rated operational power AC23									
400/415V	kW	132	220	400	400	400	400	400	400
690V	kW	240	355	800	—	—	—	—	—
Physical characteristics									
Weight ③ 3 pole	lb	2.9	5.7	11.4	35.9	38.55	127.7	127.7	127.7
Dimension 3 pole									
H	in	6.69	8.66	10	19.09	19.09	25.04	25.04	25.04
W	in	6.67	8.7	10.64	14.29	14.29	18.43	18.43	18.43
D	in	3.30	3.35	5.56	4.92	4.92	10.67	10.67	10.67
Accessories									
Terminal lug kit		OZXA-200	OZXA-400	OZXA-800	OZXA-30	OZXA-28	OZXA-28	OZXA-28/2	OZXA-28/2
Terminal shroud		•	•	•	•	•	—	—	—
Auxiliary contact		•	•	•	•	•	•	•	•
Shaft/handle diameter		6mm .24" x .24"	12mm .47" x .47"	12mm .47" x .47"	12mm .47" x .47"	12mm .47" x .47"	12mm .47" x .47"	12mm .47" x .47"	12mm .47" x .47"
Handle UL/NEMA type									
Type 1, 3R, 12		•	•	•	•	•	•	•	•
Type 1, 3R, 4, 4X, 12		•	•	•	•	•	•	•	•
Handle type									
Selector		—	—	—	—	—	—	—	—
Pistol		•	•	•	•	•	•	•	•
Recommended pistol handle length		65 - 80mm	125 - 175mm	125 - 175mm	125 - 175mm	125 - 175mm	125 - 175mm	125 - 175mm	125 - 175mm
Maximum recommended shaft length		290mm	595mm	595mm	595mm	595mm	595mm	595mm	595mm
Conversion kits									
6 pole		•	•	•	•	•	—	—	—
Transfer		•	•	•	•	•	—	—	—
Bypass		•	•	•	•	•	—	—	—
Mechanical interlock		•	•	•	•	•	•	•	•
Electrical interlock		•	•	•	•	•	•	•	•

S = Standard feature
• = Available
— = Not available

① UL listed switches are also CSA approved.
② For complete technical information please see page 18.38 – 18.70.
③ Switch only
④ IEC 947-3 Utilization Category B, Infrequent operation

Selection information

Standard part number designation ①

Non-Fusible OT Switches (16 to 125A)

OT 16 F 3 C

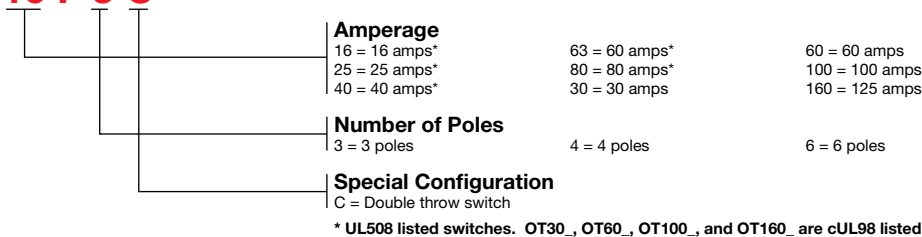

Non-Fusible OT Switches (200A and above)

OT 200 U 03 C

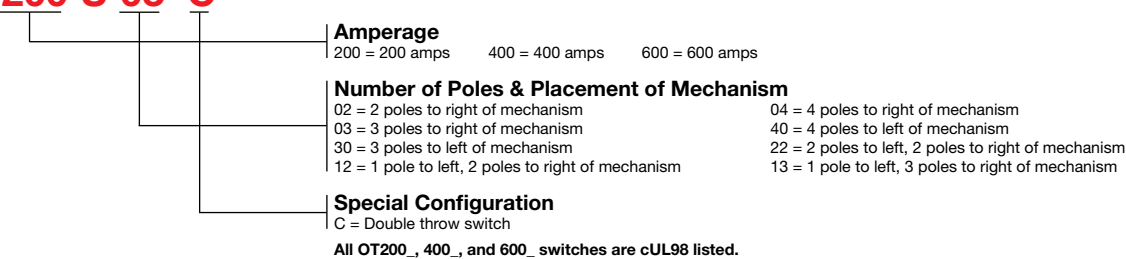

Selector Handles

OHB S 1 P H

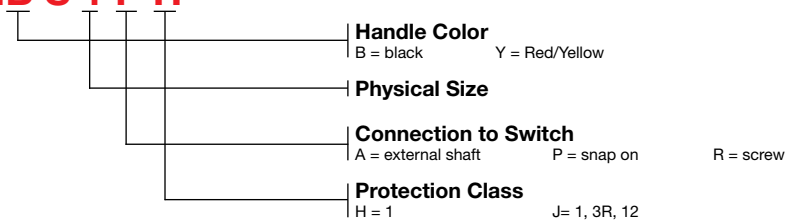

Pistol Handles

O H B 65 J 6 E011

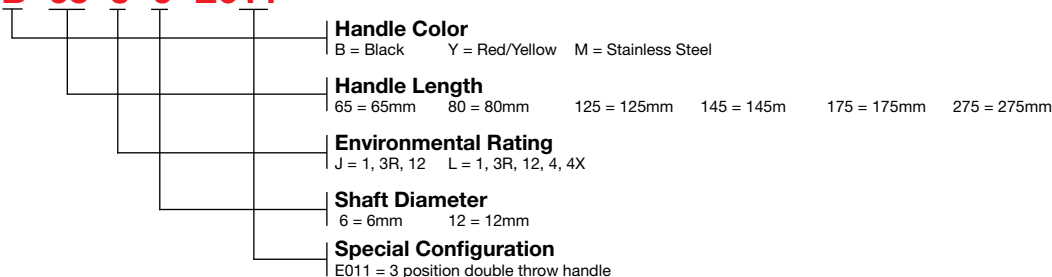

① Part designation keys are provided for reference only. Not all variations or configurations are available.

Base & DIN rail mounted ① 16A - 3150A

**Disconnect
switches
Non-fusible**

For a complete assembly,
please select one of each:

- 1 switch (pg. 18.5)
- 1 handle (pg. 18.6)
- 1 shaft (pg. 18.7)
- 1 terminal lug kit (pg. 18.9)

(Lug kits only necessary on switches 200A and above)



OT200U03



OXP6X210



OHB80J6



OZXA-200

	UL general purpose amp rating	IEC AC21 amp rating	2 Pole		3 Pole		4 Pole ②		6 Pole ③	
			Catalog number	List price	Catalog number	List price	Catalog number	List price	Catalog number	List price
UL 508	16	16	—	—	OT16F3	\$ 66	—	—	OT16F6	\$ 192
	25	25	—	—	OT25F3	72	—	—	OT25F6	204
	40	40	—	—	OT40F3	76	—	—	OT40F6	212
	60	63	—	—	OT63F3	100	—	—	OT63F6	260
	80	80	—	—	OT80F3	120	—	—	OT80F6	300
UL 98	30	40	—	—	OT30F3	150	—	—	OT30F6	360
	60	63	—	—	OT60F3	175	—	—	OT60F6	410
	100	115	—	—	OT100F3	200	—	—	OT100F6	460
	125	160	—	—	OT160E3	420	—	—	—	—
	200	250	OT200U02	\$ 560	OT200U03	620	OT200U04	\$ 780	—	—
					OT200U30	620	OT200U40	780	—	—
					OT200U12	620	OT200U22	780	—	—
	400	630	OT400U02	1,280	OT400U03	1,420	OT400U04	1,800	—	—
					OT400U30	1,420	OT400U40	1,800	—	—
					OT400U12	1,420	OT400U22	1,800	—	—
	600	800	OT600U02	2,000	OT600U03	2,200	OT600U04	2,800	—	—
					OT600U30	2,200	OT600U40	2,800	—	—
					OT600U12	2,200	OT600U22	2,800	—	—
	800	1250	OETL-NF800A2SW	2,600	OETL-NF800ASW	4,200	OETL-NF800A4SW	5,200	—	—
	1200	1600	OETL-NF12002SW	6,200	OETL-NF1200SW	6,800	OETL-NF12004SW	8,600	—	—
1600	2500 ④	OETL-NF16002SW	14,800	OETL-NF1600SW	16,400	OETL-NF16004SW	20,500	—	—	
2000	2500 ④	OETL-NF20002SW	15,500	OETL-NF2000SW	17,200	OETL-NF20004SW	21,500	—	—	
-	3150 ④	OETL-NF31502SW	17,000	OETL-NF3150SW	18,900	OETL-NF31504SW	23,600	—	—	

Bulk packed 3 Pole, 600V Switches

	UL general purpose amp rating	IEC AC21 amp rating	Bulk pack Quantity	Catalog number	List price
UL508	16	16	50	OT16F3/B	Consult factory
	25	25	50	OT25F3/B	
	40	40	50	OT40F3/B	
	60	63	50	OT63F3/B	
	80	80	50	OT80F3/B	
UL98	30	40	25	OT30F3/B	Consult factory
	60	63	25	OT60F3/B	
	100	115	25	OT100F3/B	
	125	160	10	OT160E3/B	

① Above 125A, base mount with screws only.

② A snap on fourth pole may be added on 16-125A switches. Reference pg. 18.9.

③ For a 6 or 8 pole switch 200 amp and above, a conversion mechanism accessory kit can be used with two 3 or 4 pole switches. Reference pg. 18.10.

④ Vertical busbar provided as standard on OETL-NF1600-OETL-NF3150 switches. For alternate back or edgewise mounting busbar, reference pg. 18.10.

Disconnect
switches
Non-fusible

Standard handles & shafts ① ②

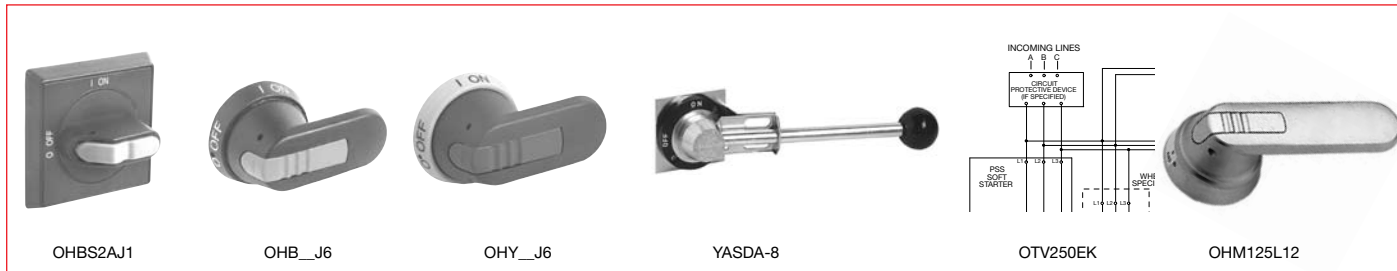

Recommended handles & shafts

Switch	Shaft diameter	Recommended standard pistol handle length	Maximum recommended shaft length
OT16 - 100	6x6 mm - .24 x .24"	45 - 65 mm	290 mm
OT160 - 200	6x6 mm - .24 x .24"	65 - 80 mm	290 mm
OT400 - 600	12x12 mm - .47 x .47"	125 - 175 mm	595 mm
OETL-NF800 - 3150	12x12 mm - .47 x .47"	125 - 175 mm	595 mm

Selector handles — for use with .24 x .24" (6mm) OXS6X shafts

UL/NEMA Type	IEC type	Color	Marking	Defeatable	Padlockable	Weight (lbs)	Catalog number	List price
1	IP54	Black	O/I & Off/On	—	—	0.09	OHBS1AH1 ③	\$ 22
					Yes	0.12	OHBS3AH1 ③	24
1, 3R, 12	IP65	Black	O/I & Off/On	—	Yes	0.16	OHBS2AJ1	28
				Yes	Yes	0.16	OHBS2AJ	30

Pistol handles — for use with .24 x .24" (6mm) OXP6X shafts

UL/NEMA Type	IEC type	Color	Marking	Length in/mm	Defeatable	Padlockable	Weight (lbs)	Catalog number	List price
1, 3R, 12	IP65	Black	O/I & Off/On	2.6/65	Yes	Yes	0.29	OHB65J6	\$ 80
				3.1/80	Yes	Yes	0.30	OHB80J6	90
1, 3R, 12, 4, 4X	IP66	Black	O/I & Off/On	3.1/80	Yes	Yes	0.30	OHB80L6	130
1, 3R, 12, 4, 4X	IP66	316L Stainless steel	O/I & Off/On	2.6/65	Yes	Yes	1.60	OHM65L6	750
1, 3R, 12	IP65	Black w/ 316 stainless hasp	O/I & Off/On	2.6/65	Yes	Yes	0.31	OHB65J6EH	250
1, 3R, 12, 4, 4X	IP66	Black w/ 316 stainless hasp	O/I & Off/On	2.6/65	Yes	Yes	0.31	OHB65L6EH	290

Pistol handles — for use with .47 x .47" (12mm) OXP12X shafts

UL/NEMA Type	IEC type	Color	Marking	Length in/mm	Defeatable	Padlockable	Weight (lbs)	Catalog number	List price
1, 3R, 12	IP65	Black	O/I & Off/On	4.9/125	Yes	Yes	0.39	OHB125J12	\$ 90
				5.7/145	Yes	Yes	0.39	OHB145J12	90
				6.9/175	Yes	Yes	0.41	OHB175J12	100
1, 3R, 12, 4, 4X	IP66	Black	O/I & Off/On	5.7/145	Yes	Yes	0.39	OHB145L12	130
				6.9/175	Yes	Yes	0.41	OHB175L12	140
1, 3R, 12, 4, 4X	IP66	Metal	Off/On	8.7/220	--	Yes	1.50	YASDA-8	190
1, 3R, 12, 4, 4X	IP66	316L Stainless steel	O/I & Off/On	4.9/125	Yes	Yes	1.70	OHM125L12	900
				6.9/175	Yes	Yes	1.80	OHM175L12	1,100
				275	Yes	Yes	2.10	OHM275L12	1,200
1, 3R, 12	IP65	Black w/ 316 stainless hasp	O/I & Off/On	4.9/125	Yes	Yes	0.44	OHB125J12EH	280
				6.9/175	Yes	Yes	0.46	OHB175J12EH	330
1, 3R, 12, 4, 4X	IP66	Black w/ 316 stainless hasp	O/I & Off/On	4.9/125	Yes	Yes	0.44	OHB125L12EH	330
				6.9/175	Yes	Yes	0.46	OHB175L12EH	390

Direct mount handle

Description	For use on	Color	Padlockable	Weight	Catalog number	List price
Mounts directly on switch. No shaft necessary	OT16-40	Black	Yes	0.05	OHBS12 ④	\$ 17
	OT63-80				OHBS2 ④	
	OT30-100					
Mounts directly on switch. No shaft necessary	OT160	Black	Yes	0.05	OHB13	22
Up to 3 padlocks in OFF-position, includes shaft and mechanism	OT200	Black	Yes	0.22	OTV250EK	105
	OT400	Black	Yes	0.44	OTV400EK	130
	OT600	Black	Yes	0.66	OTV800EK	155
Mounts on shaft	OT400-OETL NF800	Metal	No	0.78	YASDA-33	155
	OETL-NF1200-OETL-NF3150	Metal	No	0.80	YASDA-34	180

① Red/Yellow handles are available by substituting the OHB prefix with OHY.

② All handles are plastic unless otherwise noted as metal or stainless steel.

③ Not recommended for use on OT30-100.

④ Suitable for 3 & 4 pole versions only. Not for use with 6 or 8 pole or double throw configurations.

Standard handles & shafts

Disconnect
switches
Non-fusible



Shafts for use with selector handles – .24 x .24" (6x6 mm)

Shaft length (in/mm)	Maximum Mounting Depth (inches) ①					Weight	Catalog number	List price
	OT16F3, OT25F3, OT40F3		OT63F3, OT80F3		OT30F3, OT60F3, OT100F3			
	OH_1_ & OH_3_	OH_2_	OH_1_ & OH_3_	OH_2_	OH_2_			
3.3/85	5.0	4.3	5.6	5.0	5.0	0.07	OXS6X85	\$ 4
4.1/105	5.8	5.1	6.4	5.8	5.8	0.07	OXS6X105	4
4.7/120	6.4	5.8	7.0	6.4	6.4	0.08	OXS6X120	4
5.1/130	6.7	6.1	7.4	6.8	6.8	0.08	OXS6X130	6
7.1/180	8.7	8.1	9.4	8.7	8.7	0.11	OXS6X180	6
9.8/250	11.5	10.8	12.1	11.5	9.9	0.13	OXS6X250	12
13/330	14.6	14.0	15.3	14.7	14.6	0.17	OXS6X330	20

Shafts for use with pistol handles – .24 x .24" (6x6 mm)

Shaft length (in/mm)	Maximum Mounting Depth (inches)					Weight	Catalog number	List price
	OT16F3 - OT40F3	OT63F3-OT80F3	OT30F3-OT100F3	OT160E3	OT200			
5.2/130	5.9	6.4	6.7	6.0	6.5	0.08	OX6X130	\$ 12
5.9/150	6.7	7.4	7.0	6.7	7.2	0.09	OX6X150	12
8.3/210	9.1	9.7	9.8	9.1	9.6	0.13	OX6X210	16
11.4/290	12.2	12.8	12.9	12.2	12.7	0.18	OX6X290	20
14.2/360	14.9	13.8	15.6	15.0	15.5	0.23	OX6X360	24
16.9/430	17.6	18.3	18.3	17.8	18.2	0.27	OX6X430	28

Shafts for use with pistol handles – .47 x .47" (12x12 mm)

Shaft length (in/mm)	Maximum Mounting Depth (inches)				Weight	Catalog number	List price
	OT400	OT600	OETL-NF800 – OETL-NF1200	OETL-NF1600-OETL-NF3150			
11.0/280	13.3	14.6	14.5	—	0.77	OX12X280	\$ 36
12.8/325	15.0	16.4	16.3	20.9	0.90	OX12X325	40
15.6/395	20.5	19.1	19.1	23.6	1.10	OX12X395	44
18.3/465	21.9	21.8	21.9	26.3	1.32	OX12X465	48
21.1/535	22.8	24.6	24.6	29.1	1.54	OX12X535	52

18

① Mounting depth is distance from the outside of the door to the disconnect switch mounting plate. Shaft can be cut to desired length.

Standard non-fusible accessories Base and DIN rail mounted switches

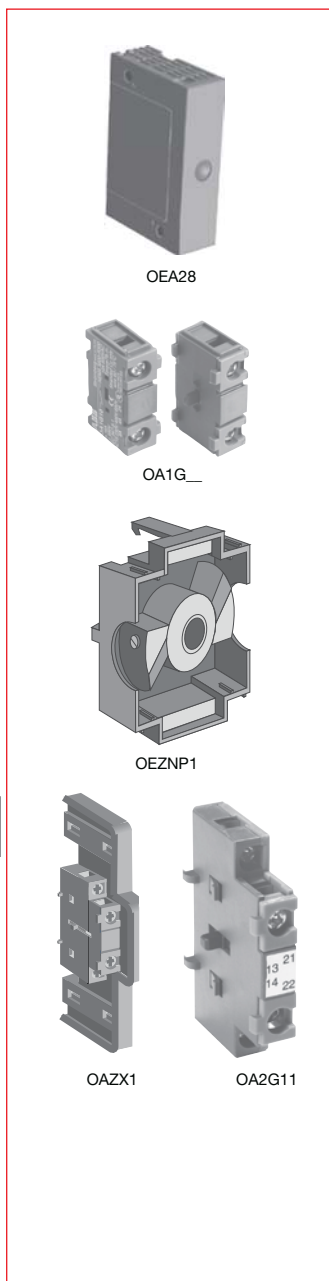
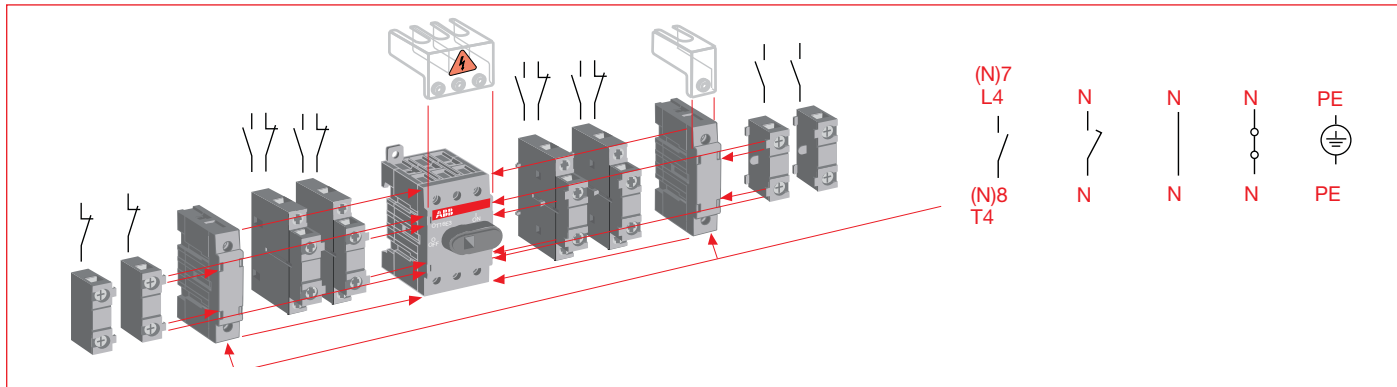

Auxiliary contacts — snap-on mounting ①

Description	For Use On	Weight	AC Thermal amp rating	AC rated voltage	Catalog number	List price
1 N.O.	OT16-100, OT200-600	0.07	10	600	OA1G10	\$ 20
1 N.C.	OT16-100 OT200-600	0.07 0.07	10 10	600 600	OA1G01 OA3G01	20 20
1 N.O. & 1 N.C.	OT16-160	0.07	10	600	OA2G11	40
Mounting Base - required for OA2G11 on OT160	OT160	0.06	-	-	OAZX1	20
Module for auxiliary contacts	OT200-600	0.1	-	-	OEA28	50

Auxiliary contacts — top mounting

Description	For Use On	Weight	AC Thermal amp rating	AC rated voltage	Catalog number	List price
1 N.O.	OEZNP1	0.07	10	600	OBEA-10	\$ 28
1 N.C.	OT160	0.07	10	600	OBEA-01	28
1 N.O. gold plated ②	OEZNP1 & OT160	0.07 0.07	10 10	600 600	OBEA-10AU OBEA-01AU	56 56
Mounting Base - required for OBEA_	OBEA_ contacts used with OT160	0.06	-	-	OEZNP1	20
1 pkg. of 10 blank numbering labels for OBEA- ③	OT160 OT160	- -	- -	- -	OBEA-ZX10 OBEA-ZX01	32 32

Auxiliary contacts — front mounting ④

Description	For Use On	Weight	AC Thermal amp rating	AC rated voltage	Catalog number	List price
1 N.O. + 1 N.C.	OETL-NF800 through OETL-NF3150	0.2	10	600	OZXK-1	\$ 100
2 N.O. + 2 N.C.		0.26	10	600	OZXK-2	170
4 N.O. + 4 N.C.		0.4	10	600	OZXK-3	340
2 N.O.	OETL-NF3150	0.18	10	600	OZXK-4	100
4 N.O.		0.25	10	600	OZXK-5	170
8 N.O.		0.4	10	600	OZXK-6	340

Mounting & installation considerations

OT16-100	OA1G10 (1 N.O.) mounts on right side of switch only OA1G01 (1 N.C.) mounts on left side of switch only OA2G11 (1 N.O. & 1 N.C.) mounts on left of right side of switch Maximum two contacts on each side of switch
OT160	Accepts four contacts maximum Mounting base always required Maximum two side mounted contacts on each side of switch. One mounting base required for each side
OT200-600	Maximum 8 auxiliary contact blocks with the OEA28 module Maximum 4 auxiliary contact blocks mounting under the mechanisms

① UL file #E83510

② Type _AU for low energy applications. The contacts are gold plated, AC & DC ratings - Maximum: A600 & P600; Minimum: 12V, 1mA; 5V; 2mA

③ Numbering stickers required if several OBEA contacts are used in the same installation.

④ UL File #E5707

Standard non-fusible accessories

Base & DIN rail mounted switches

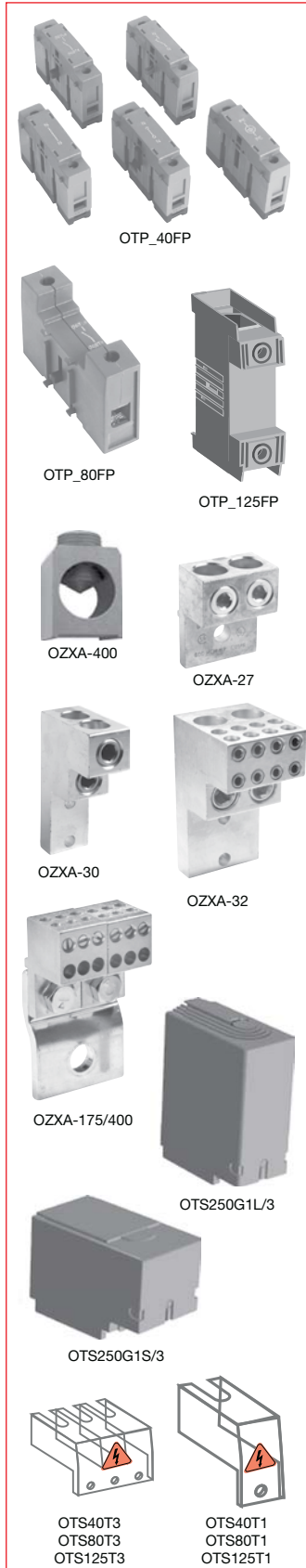

Disconnect
switches
Non-fusible



Additional poles ①



Power poles

Only one power pole per switch: mounts on left or right side of switch

Description	For use on	Weight	AC Thermal amp rating	AC rated voltage	Catalog number	List price
 Fourth Pole	OT16-OT40	0.07	40	600	OTPS40FPN1	\$ 36
	OT30-OT60	0.13	60		OTPS60FP	46
	OT63-OT80	0.13	80		OTPS80FP	44
	OT100-OT160	0.31	100		OTPS125FP	54
 Late-break/ early-make	OT16-OT40	0.07	40	600	OTPL40FP	36
	OT30-OT60	0.13	60		OTPL60FP	46
	OT63-OT80	0.13	80		OTPL80FP	44
	OT100-OT160	0.31	100		OTPL125FP	54

Terminal poles

Switch accepts one terminal pole per side: mounts on left or right side of switch

Description	For use on	Weight	AC Thermal amp rating	AC rated voltage	Catalog number	List price
 Solid neutral	OT16-OT40	0.07	40	600	OTPN40FP	\$ 20
	OT63-OT80	0.13	80		OTPN80FP	36
	OT30-OT100	0.31	100		OTPN125FP	50
 Detachable Neutral	OT16-OT40	0.07	40	600	OTPD40FP	28
	OT30-OT60	0.13	60		OTPD60FP	38
	OT63-OT80	0.13	80		OTPD80FP	36
	OT100-OT160	0.31	60		OTPD125FP	50
 Ground Terminal	OT16-OT40	0.07	40	600	OTPE40FP	20
	OT30-OT60	0.13	60		OTPE60FP	38
	OT63-OT80	0.13	80		OTPE80FP	36
	OT30-OT160	0.31	100		OTPE125FP	50

Terminal lugs ②

For Use On	Wire Size	Wire Type	Lugs/Kit	Weight (lbs)	Catalog number	List price
OT200	#4 - 300 kcmil	Cu/Al	6	0.50	OZXA-200	\$ 80
	#4 - 300 kcmil		3	0.25	OZXA-200/3	40
	(6) 14-6 AWG		3	0.25	OZXA-206T	200
OT400	#2 - 600 kcmil	Cu/Al	6	0.50	OZXA-400	190
	#2 - 600 kcmil		3	0.25	OZXA-400/3P	100
	(2) #4 - 300 kcmil		6	0.50	OZXA-402	210
	(6) #14 - 6 AWG		3	0.50	OZXA-406	270
OT600	(2) #2 - 600 kcmil	Cu/Al	6	0.50	OZXA-800	360
	(2) #2 - 600 kcmil		3	0.50	OZXA-800/3	180
OETL-NF800A	(2) #2 - 600 kcmil	Cu/Al	6	6.90	OZXA-30	740
	(2) #2 - 600 cmil		3	3.45	OZXA-30/3P	370
	(8) 2/0 + (2) #2 - 600 kcmil ③		3	6.90	OZXA-32	600
OETL-NF1200-1600	(4) #2 - 600 kcmil	Cu/Al	6	10.44	OZXA-28	1,000
	(4) #2 - 600 kcmil		3	5.22	OZXA-28/3	500
	(8) 2/0 + (2) #2 - 600 kcmil ③		3	10.44	OZXA-32	600
OETL-NF2000-3150	(8) #2 - 600 kcmil	Cu/Al	12	20.88	OZXA-28/2	2,000

Terminal shrouds

Description	For Use On	Weight	Catalog number	List price
3 pole includes one shroud for line or load side	OT16-OT40	0.02	OTS40T3	\$ 8
	OT63-OT80	0.02	OTS80T3	20
	OT30-OT100	0.02	OTS125T3	20
4th pole includes one shroud for line or load side	OTPS40FPN1	0.03	OTS40T1	4
	OTPS80FP	0.03	OTS80T1	6
	OTPS125FP	0.03	OTS125T1	10
3 pole long type shrouds	OT200	0.2	OTS250G1L/3	50
3 pole short type shrouds		0.13	OTS250G1S/3	50
4 pole long type shrouds		0.26	OTS250G1L/4	65
4 pole short type shrouds		3.18	OTS250G1S/4	65
3 pole includes one shroud for line or load side ④	OT400	0.33	OTS403	120
	OT600	0.33	OTS603	190
3 pole includes one shroud for line or load side ④	OETL-NF800A	0.88	OETL-ZX800A	180
	OETL-NF1200	1.2	OETL-ZX119	220

① Switches accept only one power pole or one terminal pole per side. Only one power pole per switch.

② Lugs are integral to the switch for 16-125A. No separate lug kit accessory is required.

③ A load side distribution lug eliminates the need to purchase, install and wire a separate distribution block.

④ For 4 pole shrouds, please consult factory.

Standard non-fusible accessories Base and DIN rail mounted switches

Conversion Mechanisms

Mechanism Type	For use on	Weight	UL/Nema Type	Catalog number	List price
6 or 8 pole mechanisms	OT16-100	0.33	-	OTZW8	\$ 60
	OT160	1.52	-	OETL-ZK19	40
	OT200	1.52	-	OESA-ZW2	220
	OT400 – OETL-NF1200	2.42	-	OETL-ZW9	260
Double throw mechanisms	OT16 - 160	2.20	1, 3R, 12 1, 3R, 12, 4, 4X	OESA-ZW1 OESA-ZW1X	300 340
	OT200	2.20	1, 3R, 12 1, 3R, 12, 4, 4X	OTZW25 OTZW25X	790 840
	OT400 – OETL-NF1200	10.10	1, 3R, 12, 4, 4X	OETL-ZW12	560
Bypass mechanisms	OT16-OT100	1.54	1, 3R, 12 1, 3R, 12, 4, 4X	OTZW17 OTZW17X	340 380
	OT200	7.28	1, 3R, 12	OTZW26	950
	OT400 – OETL-NF1200	8.81	1, 3R, 12, 4, 4X	OETL-ZW13	560
Mechanical interlock mechanisms	OT16-OT100	0.33	-	OETL-ZW24	80
	OT160-200	0.55	-	OTZW10	100
	OT400 – OETL-NF800	1.26	-	OETL-ZW3	140
	OETL-NF1200 – OETL-NF3150	2.64	-	OETL-ZW15	160

Miscellaneous Accessories & Replacement Parts

Shaft Accessories

Accessory Type	Description	For Use On	Weight	Catalog number	List price
Shaft Adapter	Adapts one end of a 6mm shaft to 12mm (use with shaft extension coupler)	6mm shafts	0.20	OETL-ZK19	\$ 40
Shaft Extension Coupler	Joins two shafts together for applications where extended length is required	6mm shafts 12mm shafts	0.26 0.26	OESA-ZX167 OETL-ZX95	56 100
Shaft Guide	Fits all pistol grip handles, mounts on the inside of the enclosure door with provided hardware	pistol handles	-	OHZX10	12

Busbar Connections

Accessory Type	Description	For Use On	Weight	Catalog number	List price
Busbar Connections	Vertical, back or edgewise mounting ①	OETL-NF1600 – 3150	46.2	OETL-ZX115	\$ 3,916
			31.0	OETL-ZX114	2,820

Locking Accessories

Accessory Type	Description	For Use On	Weight	Catalog number	List price
Cam Attachment	For Kirk Key, Castell, Low & Fletcher and Ronis interlock. For adapting to the interlock system. The interlock is not included.	12mm shafts	0.29	OETL-ZW5	\$ 190
Electrical Interlock	Closed circuit principle for interlocking the switch movement. When the coil circuit is dead, A-types cannot be operated to O-position and L-types cannot be operated to ON- or OFF-position. Coil voltages 110VAC, 220 VAC, 24VDC, 48VDC, 60VDC, 110VDC, 220VDC, P - 15W U = 0.7 - 1.1 Un (U = coil voltage, Un = nominal voltage)	OETL-NF800 – 3150A	2.42	OETL-ZT80AΔ OETL-ZT80LΔ	1280 1220

Δ = Coil Voltage

Replacement Parts

Accessory Type	Description	For Use On	Catalog number	List price
Metal collar	Replaces original black knob for locking shaft in place	OT16-200	OTZS2	13
Set Screw	Set screw for use with knob or collar	OT16-100	FLSWM5X8AX	2
		OT200	FLSWM5X6X	2

① Vertical busbar is provided as standard on OETL-NF1600 through OETL-NF3150 switches.

