

# Manual motor starter MS132

Manual motor starters are electro-mechanical protection devices for the main circuit. They are used mainly to switch motors manually ON/OFF and protect them fuse less against short-circuit, overload and phase failures.

Fuse less protection with a manual motor starter saves costs, space and ensures a quick reaction under short-circuit condition, by switching off the motor within milliseconds. Fuse less starter combinations are setup together with contactors.



2CDC241020F0009

**Description**

- Overload protection – trip class 10
- Phase loss sensitivity
- Disconnect function
- Temperature compensation from -25 ... +60 °C
- Adjustable current setting for overload protection
- Suitable for three- and single-phase application
- Trip-free mechanism
- Status indication
- Clear switch position indication ON/OFF/TRIP
- Lockable handle

**Approvals**

- cULus UL 508
- CB scheme
- CCC
- GOST-R
- GOST-F
- ABS
- Lloyd's Register
- GL
- DNV
- RINA

**Marks**

CE

**Order data**

MS132 screw terminal



Setting range	Type	Trip class	Order code	Pack- ing unit	Weight per PCE
A				PCE	kg
0.10...0.16	MS132-0.16	10A	1SAM350000R1001	1	0.215
0.16...0.25	MS132-0.25	10	1SAM350000R1002	1	0.215
0.25...0.40	MS132-0.4	10	1SAM350000R1003	1	0.215
0.40...0.63	MS132-0.63	10	1SAM350000R1004	1	0.215
0.63...1.00	MS132-1.0	10	1SAM350000R1005	1	0.215
1.00...1.60	MS132-1.6	10	1SAM350000R1006	1	0.265
1.60...2.50	MS132-2.5	10	1SAM350000R1007	1	0.265
2.50...4.00	MS132-4.0	10	1SAM350000R1008	1	0.265
4.00...6.30	MS132-6.3	10	1SAM350000R1009	1	0.265
6.30...10.0	MS132-10	10	1SAM350000R1010	1	0.265
8.00...12.0	MS132-12	10	1SAM350000R1012	1	0.310
10.0...16.0	MS132-16	10	1SAM350000R1011	1	0.310
16.0...20.0	MS132-20	10	1SAM350000R1013	1	0.310
20.0...25.0	MS132-25	10	1SAM350000R1014	1	0.310
25.0...32.0	MS132-32	10	1SAM350000R1015	1	0.310

Note: MS132 with pre-assembled auxiliary contact HKF1-11, please order as follow 1SAM350005Rxxxx

## Functional description

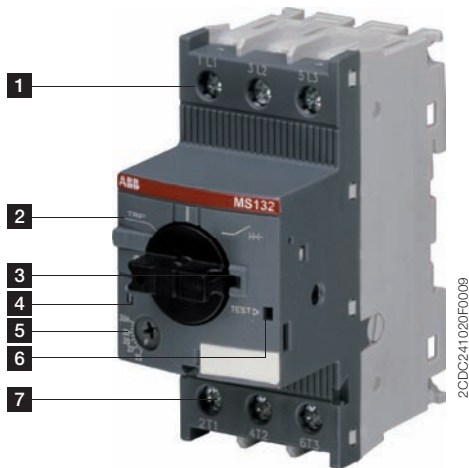

- 1** Terminals 1L1, 3L2, 5L3
- 2** Switch position TRIP
- 3** Lockable handle
- 4** Status indication for short-circuit
- 5** Current setting range  
Adjustable current setting for overload protection
- 6** Test function
- 7** Terminals 2T1, 4T2, 6T3

## Application

The manual motor starters protect the load and the installation against short-circuit and overload. They are three pole protection devices with thermal tripping elements for overload protection and electromagnetic tripping elements for short-circuit protection. Furthermore, they provide a disconnect function for safely isolation of the installation and the supply and can be used for the manual switching of loads.

The manual motor starters have a setting scale in amperes, which allows the direct adjusting of the device without any additional calculation. In compliance with international and national standards, the setting current is the rated current of the motor and not the tripping current (no tripping at  $1.05 \times I$ , tripping at  $1.2 \times I$ ;  $I$  = setting current).

## Operation mode

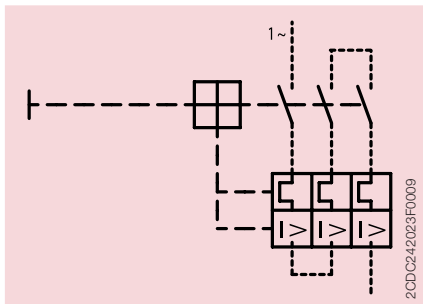

Single-phase operation

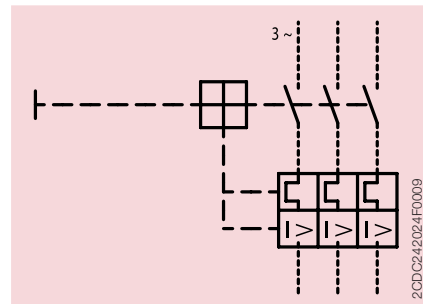

Three-phase operation

## Wiring diagram

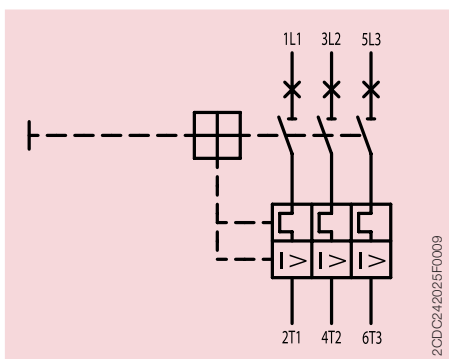

## Resistance and power loss per pole

Type	Setting range		Resistance per pole $\Omega$	Power loss per pole	
	lower value A	upper value A		at lower value W	at upper value W
MS132-0.16	0.10	0.16	66.00	0.7	1.7
MS132-0.25	0.16	0.25	25.50	0.7	1.7
MS132-0.4	0.25	0.40	10.38	0.7	1.7
MS132-0.63	0.40	0.63	4.36	0.7	1.7
MS132-1.0	0.63	1.00	1.605	0.7	1.7
MS132-1.6	1.00	1.60	0.648	0.7	1.7
MS132-2.5	1.60	2.50	0.272	0.7	1.7
MS132-4.0	2.50	4.00	0.106	0.7	1.7
MS132-6.3	4.00	6.30	0.046	0.7	1.7
MS132-10	6.30	10.0	0.024	0.9	2.4
MS132-12	8.00	12.0	0.016	1.0	2.3
MS132-16	10.0	16.0	0.011	1.1	2.8
MS132-20	16.0	20.0	0.0057	1.5	2.3
MS132-25	20.0	25.0	0.0045	1.8	2.8
MS132-32	25.0	32.0	0.0030	1.9	3.1

## Technical diagram

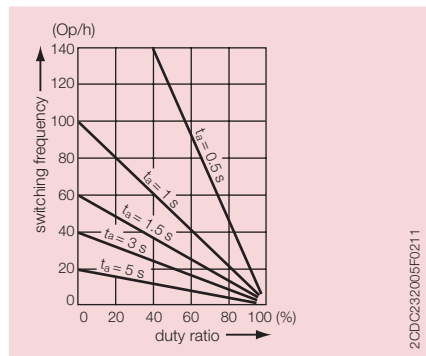

Intermittent periodic duty,  $t_a$ : Motor starting time

## Dimensions

in mm / inches

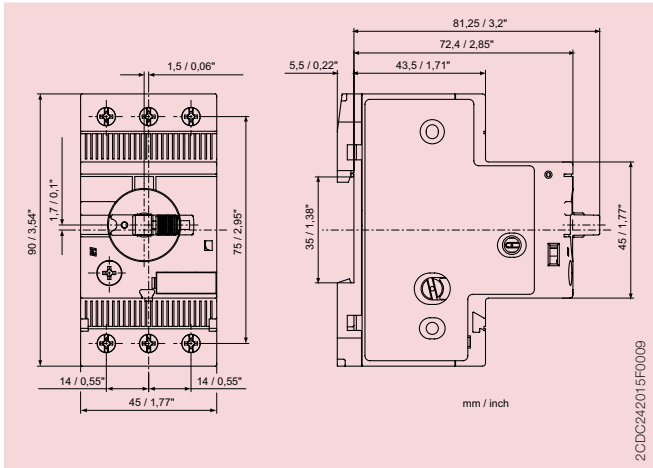

MS132 ≤ 10 A

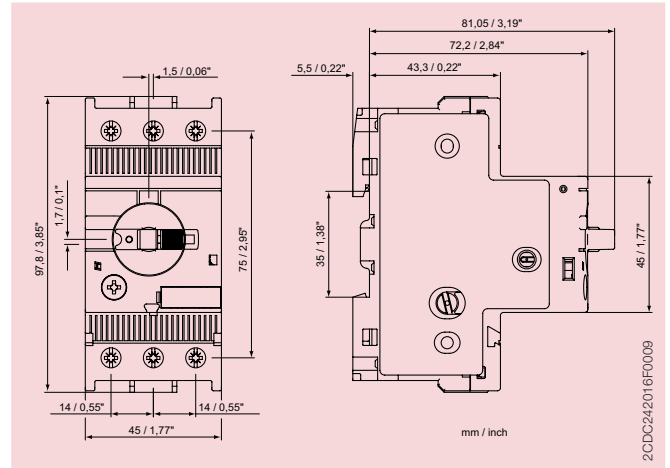

MS132 > 10 A

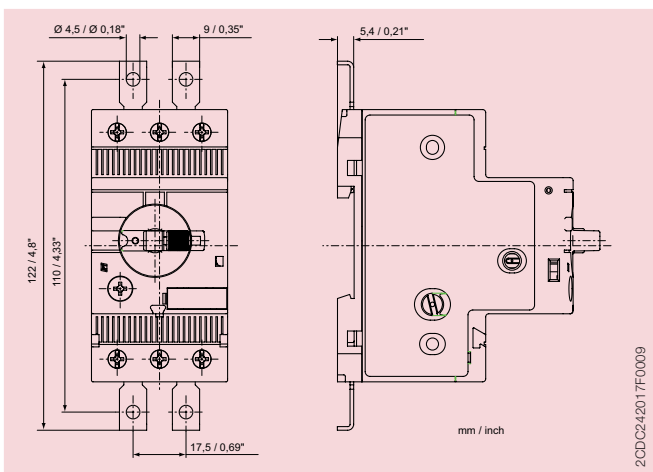

MS132 ≤ 10 A with screw fixing kit FS116 (accessory)

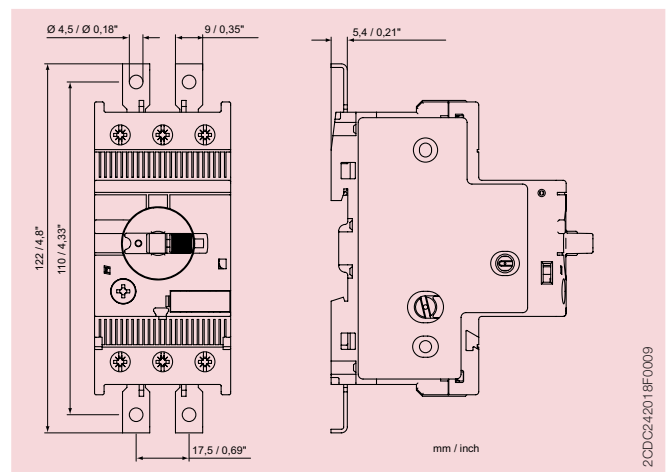

MS132 > 10 A + with screw fixing kit FS116 (accessory)

## Technical data IEC/EN

Data at  $T_A = 40\text{ °C}$  and at rated values, if nothing else indicated

### Main circuit

	<b>1L1-3L2-5L3</b> <b>2T1-4T2-6T3</b>
Rated operational voltage $U_e$	690 V AC 250 V DC
Setting range - thermal overload protection	see table "Order data" on page 1
Rated operational current $I_n$	see table below
Rated operational current DC-5 $I_e$ 3 conducting paths in series up to 250 V	see "Rated operational current $I_e$ "
Rated instantaneous short-circuit current setting $I_i$	see table below
Rated service short-circuit breaking capacity $I_{cs}$	see table "Short-circuit breaking capacity and back-up fuses" on page 7
Rated ultimate short-circuit breaking capacity $I_{cu}$ Rated service short-circuit breaking capacity DC $I_{cs}$ 3 conducting paths in series up to 250 V	10 kA
Trip class	see table "Order data" on page 1
Rated frequency	DC, 50/60 Hz
Number of poles	3
Resistance per pole	see table "Resistance and power loss per pole"
Power loss per pole	on page 3

### Isolation data

Rated impulse withstand voltage $U_{imp}$	6 kV
Rated insulation voltage $U_i$	690 V
Pollution degree	3

### Electrical connection

		<b>MS132 ≤ 10 A</b>	<b>MS132-12, -16</b>	<b>MS132-20, -25, -32</b>
Connecting capacity	solid	1/2 x 1 ... 4 mm <sup>2</sup>		1/2 x 2.5 ... 6 mm <sup>2</sup>
	stranded	1/2 x 1 ... 4 mm <sup>2</sup>		1/2 x 2.5 ... 6 mm <sup>2</sup>
	flexible with ferrule	1/2 x 0.75 ... 2.5 mm <sup>2</sup>		1/2 x 1 ... 6 mm <sup>2</sup>
	flexible with ferrule insulated	1/2 x 0.75 ... 2.5 mm <sup>2</sup>		1/2 x 1 ... 6 mm <sup>2</sup>
	flexible without ferrule	1/2 x 0.75 ... 2.5 mm <sup>2</sup>		1/2 x 2.5 ... 6 mm <sup>2</sup>
Stripping length		9 mm	10 mm	10 mm
Tightening torques		0.8 ... 1.2 Nm	1.5 Nm	2 Nm
Connection screw		M3.5	M4	M4
		(Pozidrive 2)	(Pozidrive 2)	(Pozidrive 2)

Type	Rated instantaneous short-circuit current setting $I_i$	Rated operational current $I_n$
	A	A
MS132-0.16	1.56	0.16
MS132-0.25	2.44	0.25
MS132-0.4	3.90	0.40
MS132-0.63	6.14	0.63
MS132-1.0	11.50	1.00
MS132-1.6	18.40	1.60
MS132-2.5	28.75	2.50
MS132-4.0	50.00	4.00
MS132-6.3	78.75	6.30
MS132-10	150	10.0
MS132-12	180	12.0
MS132-16	240	16.0
MS132-20	300	20.0
MS132-25	375	25.0
MS132-32	480	32.0

## General data

Mechanical durability		10 <sup>5</sup>
Electrical durability		5 x 10 <sup>4</sup>
Duty time		100 %
Operating frequency without early tripping		up to 15 operations/h or 60 operations/h with 40 % duty ratio, if the motor breaking current $6 \times I_n$ and the motor starting time does not exceed 1 s
Dimensions (W x H x D)		see drawing "Dimensions" on page 4
Weight		see table "Order data" on page 1
Mounting		DIN-rail (EN 60715)
Mounting position		position 1-6 (optional for single mounting)
Group mounting		on request
Minimum distance to other units same type	horizontal	0 mm
	vertical	150 mm
Minimum distance to electrical conductive board	horizontal, up to 400 V	0 mm
	horizontal, up to 690 V	> 1.5 mm
	vertical	75 mm
Degree of protection	enclosure / terminals	IP20
Utilization category		A
Maximum operating altitude		up to 2000 m
Maximum operating frequency		170 cycles/h

## Electromagnetic compatibility

Electromagnetic compatibility		not applicable
-------------------------------	--	----------------

## Environmental data

Ambient air temperature		
Operation	open - compensated acc. to IEC/EN 60947-4-1	-25 ... +60 °C
	open	-25 ... +70 °C
	enclosed (IB132)	0 ... +40 °C
Storage		-50 ... +80 °C
Ambient air temperature compensation		continuous
Vibration (sinusoidal) acc. to IEC/EN 60068-2-6 (Fc)		5g / 3 ... 150 Hz
Shock (half-sine) acc. to IEC/EN 60068-2-27 (Ea)		25g / 11 ms

## Standards / directives

Product standard		IEC/EN 60947-2 IEC/EN 60947-4-1 IEC/EN 60947-1 UL 508, CSA 22.2 No. 14
Low Voltage Directive		2006/95/EC
EMC Directive		2004/108/EC
RoHS Directive		2002/95/EC

## Short-circuit breaking capacity and back-up fuses

$I_{cs}$  Rated service short-circuit breaking capacity

$I_{cu}$  Rated ultimate short-circuit breaking capacity

° No back-up fuse required, because short-circuit proof up to 100 kA

Type	230 V AC			400 V AC			440 V AC			500 V AC			690 V AC		
	$I_{cs}$ kA	$I_{cu}$ kA	gG A	$I_{cs}$ kA	$I_{cu}$ kA	gG A	$I_{cs}$ kA	$I_{cu}$ kA	gG A	$I_{cs}$ kA	$I_{cu}$ kA	gG A	$I_{cs}$ kA	$I_{cu}$ kA	gG A
MS132-0.16	100	100	°	100	100	°	100	100	°	100	100	°	100	100	°
MS132-0.25	100	100	°	100	100	°	100	100	°	100	100	°	100	100	°
MS132-0.4	100	100	°	100	100	°	100	100	°	100	100	°	100	100	°
MS132-0.63	100	100	°	100	100	°	100	100	°	100	100	°	100	100	°
MS132-1.0	100	100	°	100	100	°	100	100	°	100	100	°	100	100	°
MS132-1.6	100	100	°	100	100	°	100	100	°	100	100	°	100	100	°
MS132-2.5	100	100	°	100	100	°	100	100	°	100	100	°	100	100	°
MS132-4.0	100	100	°	100	100	°	20	20	35	20	20	35	3	3	on request
MS132-6.3	100	100	°	100	100	°	20	20	63	20	20	63	3	3	on request
MS132-10	100	100	°	100	100	°	20	20	100	20	20	100	3	3	on request
MS132-12	100	100	°	100	100	°	20	20	100	20	20	100	3	3	on request
MS132-16	100	100	°	100	100	°	20	20	125	20	20	125	3	3	on request
MS132-20	100	100	°	100	100	°	20	20	125	20	20	125	3	3	on request
MS132-25	50	50	125	50	50	125	20	20	125	10	10	125	3	3	on request
MS132-32	25	50	125	25	50	125	20	20	125	10	10	125	3	3	on request

## Technical data UL/CSA

### Main circuit

Maximum operational voltage	600 V	
Manual Motor Controller ratings	see table "UL 508 – Manual Motor Controller" on page 8	
Motor ratings	Horse power	see table below
	Full load amps (FLA)	see table below
	Locked rotor amps (LRA)	see table below

Electrical connection		MS132 ≤ 10 A	MS132-12, -16	MS132-20, -25, -32
Connecting capacity	stranded	1/2 x AWG 16 ... 12		1/2 x AWG 12 ... 8
	flexible without ferrule	1/2 x AWG 16 ... 12		1/2 x AWG 12 ... 8
Stripping length		9 mm	10 mm	10 mm
Tightening torques		10 ... 12 lb-in	14 lb-in	18 lb-in
Connection screw		M3.5 (Pozidrive 2)	M4 (Pozidrive 2)	M4 (Pozidrive 2)

### Motor rating, single phase

hp Horse power

FLA Full load amps

LRA Locked rotor amps

Type	220 ... 240 V AC			440 ... 480 V AC		
	hp	FLA	LRA	hp	FLA	LRA
MS132-0.16	-	0.16	0.96	-	0.16	0.96
MS132-0.25	-	0.25	1.5	-	0.25	1.5
MS132-0.4	-	0.4	2.4	-	0.4	2.4
MS132-0.63	-	0.63	3.78	-	0.63	3.78
MS132-1.0	-	1	6	-	1	6
MS132-1.6	1/10	1.6	9.6	-	1.6	9.6
MS132-2.5	1/6	2.5	15	1/2	2.5	15
MS132-4.0	1/3	4	24	1/2	4	24
MS132-6.3	1/2	6.3	37.8	1	6.3	37.8
MS132-10	1-1/2	10	60	3	8.5	46
MS132-12	2	12	72	3	8.5	64
MS132-16	2	12	72	5	14	81
MS132-20	3	17	92	5	14	81
MS132-25	3	17	127	7-1/2	21	116
MS132-32	5	28	162	10	26	145



## Motor rating, three phase

hp Horse power

FLA Full load amps

LRA Locked rotor amps

Type	110 ... 120 V AC			220 ... 240 V AC			440 ... 480 V AC			500 ... 600 V AC		
	hp	FLA	LRA	hp	FLA	LRA	hp	FLA	LRA	hp	FLA	LRA
MS132-0.16	-	0.16	0.96	-	0.16	0.96	-	0.16	0.96	-	0.16	0.96
MS132-0.25	-	0.25	1.5	-	0.25	1.5	-	0.25	1.5	-	0.25	1.5
MS132-0.4	-	0.4	2.4	-	0.4	2.4	-	0.4	2.4	-	0.4	2.4
MS132-0.63	-	0.63	3.78	-	0.63	3.78	-	0.63	3.78	-	0.63	3.78
MS132-1.0	-	1	6	-	1	6	-	1	6	1/2	1	6
MS132-1.6	-	1.6	9.6	-	1.6	9.6	3/4	1.6	9.6	3/4	1.6	9.6
MS132-2.5	-	2.5	15	1/2	2.5	15	1	2.5	15	1-1/2	2.5	15
MS132-4.0	-	4	24	1	4	24	2	4	24	3	3.9	26
MS132-6.3	1/2	6.3	37.8	1-1/2	6.3	37.8	3	4.8	32	5	6.1	37
MS132-10	3/4	10	60	3	9.6	64	5	7.6	46	7-1/2	9	51
MS132-12	1-1/2	12	72	3	9.6	64	7-1/2	11	64	10	11	65
MS132-16	2	16	84	5	15.2	92	10	14	81	10	11	65
MS132-20	3	19.2	128	5	15.2	92	10	14	81	15	17	93
MS132-25	3	19.2	128	7-1/2	22	127	15	21	116	20	22	116
MS132-32	5	30.4	184	10	28	162	20	27	145	25	27	146

## Manual Motor Controller for Motor Disconnect

Type	Maximum short-circuit current rating	
	480 V	600 V
	kA	kA
MS132-0.16	65	47
MS132-0.25	65	47
MS132-0.4	65	47
MS132-0.63	65	47
MS132-1.0	65	47
MS132-1.6	65	47
MS132-2.5	65	47
MS132-4.0	65	18
MS132-6.3	65	18
MS132-10	65	18
MS132-12	30	18
MS132-16	30	18
MS132-20	30	18
MS132-25	30	18
MS132-32	30	18

## Manual Motor Controller for Group Installation

Type	Maximum short-circuit current rating	
	480 V	600 V
	kA	kA
MS132-0.16	65	47
MS132-0.25	65	47
MS132-0.4	65	47
MS132-0.63	65	47
MS132-1.0	65	47
MS132-1.6	65	47
MS132-2.5	65	47
MS132-4.0	65	30
MS132-6.3	65	30
MS132-10	65	30
MS132-12	30	30
MS132-16	30	30
MS132-20	30	30
MS132-25	30	30
MS132-32	30	30

## Manual Motor Controller for Group Installation in combination with current limiter S803W-SCLxxx-SR

Type	Maximum short-circuit current rating	
	480 V	600 V
	kA	kA
MS132-0.16	65	65
MS132-0.25	65	65
MS132-0.4	65	65
MS132-0.63	65	65
MS132-1.0	65	65
MS132-1.6	65	65
MS132-2.5	65	65
MS132-4.0	65	65
MS132-6.3	65	65
MS132-10	65	65
MS132-12	65	65
MS132-16	65	65
MS132-20	65	65
MS132-25	65	65
MS132-32	65	65

Self-Protected Combination Motor Controller (Type E) and Combination Motor Controller (Type F)

Type	UL 508 Self-Protected Combination Motor Controller (Type E) in combination with feeder block S1-M3-xx		UL 508 Combination Motor Controller (Type F)		UL 508 Manual Motor Controller for Tap Conductor Protection	
	Maximum short-circuit current rating		Maximum short-circuit current rating	Minimum contactor size	Maximum short-circuit current rating	
	480Y / 277 V kA	600Y / 347 V kA	480Y / 277 V kA		480 V kA	600 V kA
MS132-0.16	65	47	30	AF26...AF38	65	47
MS132-0.25	65	47	30	AF26...AF38	65	47
MS132-0.4	65	47	30	AF26...AF38	65	47
MS132-0.63	65	47	30	AF26...AF38	65	47
MS132-1.0	65	47	30	AF26...AF38	65	47
MS132-1.6	65	47	30	AF26...AF38	65	47
MS132-2.5	65	47	30	AF26...AF38	65	47
MS132-4.0	65	18	30	AF26...AF38	65	18
MS132-6.3	65	-	30	AF26...AF38	65	18
MS132-10	65	-	30	AF26...AF38	65	18
MS132-12	30	-	30	AF26...AF38	30	18
MS132-16	30	-	30	AF26...AF38	30	18
MS132-20	30	-	30	AF26...AF38	30	18
MS132-25	30	-	30	AF26...AF38	30	18
MS132-32	30	-	30	AF26...AF38, A40	30	18

Self-Protected Combination Motor Controller (Type E) and Combination Motor Controller (Type F) in combination with current limiter S803W-SCLxxx-SR

Type	UL 508 Self-Protected Combination Motor Controller (Type E) in combination with current limiter S803W-SCLxxx-SR		UL 508 Combination Motor Controller (Type F) in combination with current limiter S803W-SCLxxx-SR	
	Maximum short-circuit current rating		Maximum short-circuit current rating	Minimum contactor size
	480Y / 277 V kA	600Y / 347 V kA	480Y / 277 V kA	
MS132-0.16	65	47	65	AF26...AF38
MS132-0.25	65	47	65	AF26...AF38
MS132-0.4	65	47	65	AF26...AF38
MS132-0.63	65	47	65	AF26...AF38
MS132-1.0	65	47	65	AF26...AF38
MS132-1.6	65	47	65	AF26...AF38
MS132-2.5	65	47	65	AF26...AF38
MS132-4.0	65	18	65	AF26...AF38
MS132-6.3	65	-	65	AF26...AF38
MS132-10	65	-	65	AF26...AF38
MS132-12	65	-	-	-
MS132-16	65	-	-	-
MS132-20	65	-	-	-
MS132-25	65	-	-	-
MS132-32	65	-	-	-

# Contact us

## **ABB STOTZ-KONTAKT GmbH**

Eppelheimer Straße 82  
69123 Heidelberg, Germany  
Phone: +49 (0) 6221 7 01-0  
Fax: +49 (0) 6221 7 01-13 25  
E-Mail: [info.desto@de.abb.com](mailto:info.desto@de.abb.com)

You can find the address of your  
local sales organization on the  
ABB home page  
<http://www.abb.com/contacts>  
-> Low Voltage Products and Systems

## **Note:**

We reserve the right to make technical changes or modify the contents of this document without prior notice. With regard to purchase orders, the agreed particulars shall prevail. ABB AG does not accept any responsibility whatsoever for potential errors or possible lack of information in this document.

We reserve all rights in this document and in the subject matter and illustrations contained therein. Any reproduction, disclosure to third parties or utilization of its contents – in whole or in parts – is forbidden without prior written consent of ABB AG.

Copyright© 2012 ABB  
All rights reserved