

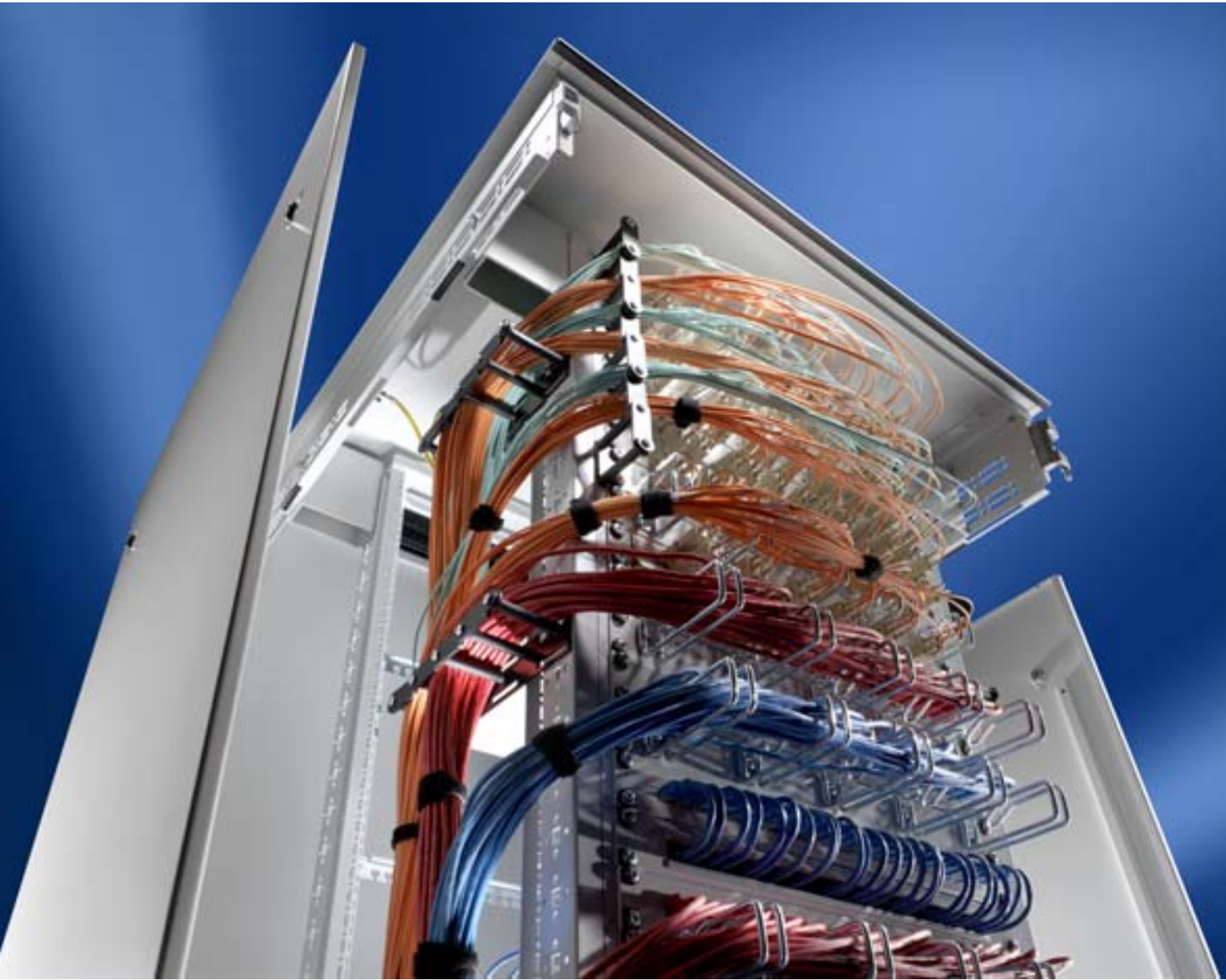

# Rittal – TE 7000



Network enclosures and server racks:  
Perfect access, fast assembly





### Fast – Network enclosures

TE 7000: Ideal for networks in all sectors of industry, telecommunications and data communication.

### Fast – Server racks

TE 7000: Load capacity 700 kg! Excellent for server mounting. Two 482.6 mm (19") attachment levels in the multi-functional profile create a solid framework.

### Fast – TE 7000 open

TE 7000: All-round access, prepared for plug & play with system accessories – ideal for network and server rooms.



## SIMPLY FASTER – OPEN FOR ANY SOLUTION

Finished already! The “network specialist” will astound you. This is because Rittal takes a direct approach. You will be amazed at how quickly the TE 7000 is ready to use.

It couldn't be any faster: The TE 7000 is already at one of our sales and logistic centres near you. System accessories for **infinite installation diversity**, comprehensive access, climate and security concepts and perfect global services make it all possible.

**Rittal TE 7000 – top efficiency  
for perfect access and fast assembly.**



### Fast, easy transportation

Because it is readily dismantled, the TE 7000 rack is easily transported to the installation site.

### Fast depth variability

The dimensions and attachment points of the two mounting levels are tailored to fixed standard dimensions. The preset distance between levels may be easily and individually varied.

### Rapid access

The benefits of this rack without an enclosure frame: Optimum accessibility, maximum use of the interior space, super-fast assembly.





**Spot-on: 482.6 mm (19") drawer**  
to effortlessly accommodate surplus cables. Just one example of the infinite possibilities with Rittal system accessories.

**Spot-on: Cable routing at every level**  
Simply secure, and it's done. When it comes to perfect cable management, there are no limits to solving individual requirements.

**Spot-on: Simple installation and removal of doors and side panels,** thanks to easy-fit hinge bolts and locks.



## EVERYTHING IS SPOT-ON: OUTSTANDING AT ALL LEVELS

Rittal, as your system supplier, offers **diversity through modular technology** as part of its standard range. The benefit to you: cost-effective, time-saving configuration with **system accessories**. Precisely tailored to your requirements.

Check out the details of the Rittal TE 7000: **Optimum use of space**, direct installation on the 482.6 mm (19") mounting frame, integral TS 8 system punchings, **depth-variable** configuration. Plus **security concepts** to your precise requirements. After all, data protection and availability are a key factor of your productivity.

**Rittal TE 7000 – everything is spot-on: simple, fast, flexible.**



**Spot-on: Depth-variable installation**  
Universal interior installation with depth-variable rails and component shelves.  
Rittal TE 7000

**Spot-on: Effective space utilisation**  
Ready in a flash: Every dimension and every locating point is precisely defined. All this plus matching system accessories and components for power supply, climate control and security.

**Spot-on: One-man assembly**  
From the base/plinth to the top-mounted fan, from the lock system to the comprehensive security equipment – everything can be assembled by one person.





# TE 7000 network enclosures



## This is what TE Top Efficiency looks like!

The rack for rational, cost-effective cabling, ready to use in network distribution:

At its core is the robust frame comprising two 482.6 mm (19") attachment levels. Add to this a host of useful accessories from Rittal's comprehensive modular system, and you will arrive at the precise configuration which meets your requirements to perfection, quickly and cost effectively.

## Note:

TE 7000 network enclosures, see page 14.

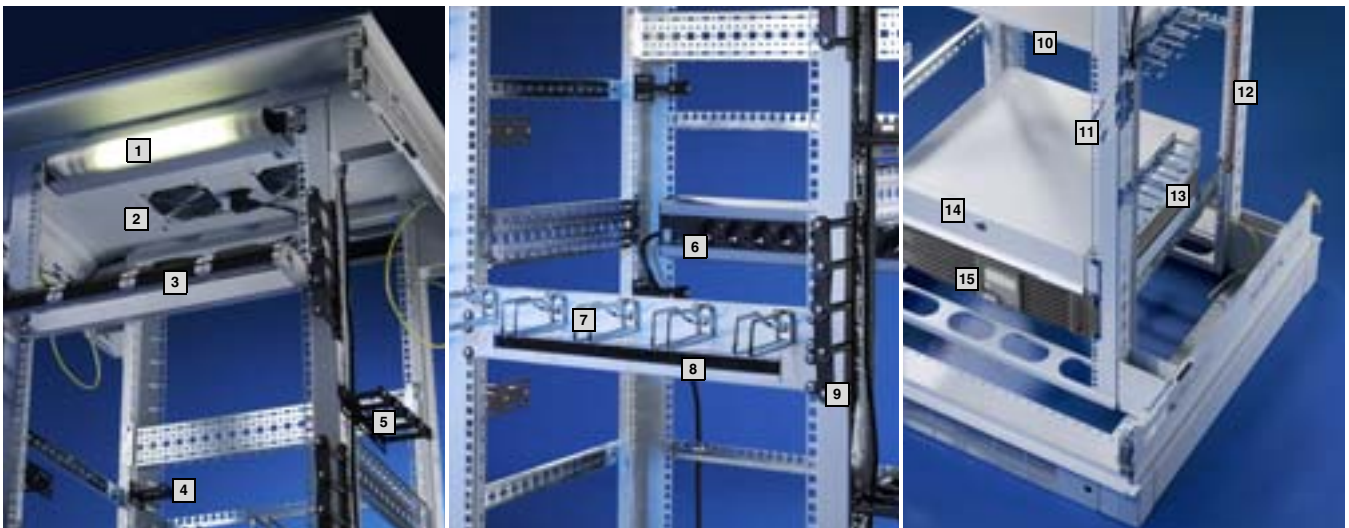

### Example: System accessories for perfect configuration of a TE 7000 network enclosure

Use these examples to help you.

Socket strips, lights, cable management devices and other system accessories are all available from Rittal, in a wide range of variants suitable for different applications.

- 1** Light, 1 U
- 2** Fan unit, active
- 3** Fibre-optic cable management panel, 1 U
- 4** Cable routing bar, 1 U
- 5** Cable routing bar, 4 U
- 6** Socket strip TE, 8-way
- 7** Cable management panel, 1 U
- 8** Cable gland panel
- 9** Cable routing bar, cranked, 4 U
- 10** Component shelf, static installation
- 11** Distributor clip, small
- 12** Earth rail
- 13** Distributor clip, large
- 14** Drawer, 2 U
- 15** UPS, single-phase





# TE 7000 server rack



## Top Efficiency – The TE 7000 as server rack!

In depths of up to 1000 mm, the TE offers a rational, cost-effective solution to your server room and data centre requirements with a stable, depth-variable 482.6 mm (19") frame. Optimum installation access with the doors and walls removed.

## Rittal offers everything needed to configure a plug & play

**rack:** Compatible modules for power supply, cooling, security, monitoring, and a comprehensive range of system accessories.

## Note:

TE 7000 server racks, see page 22.

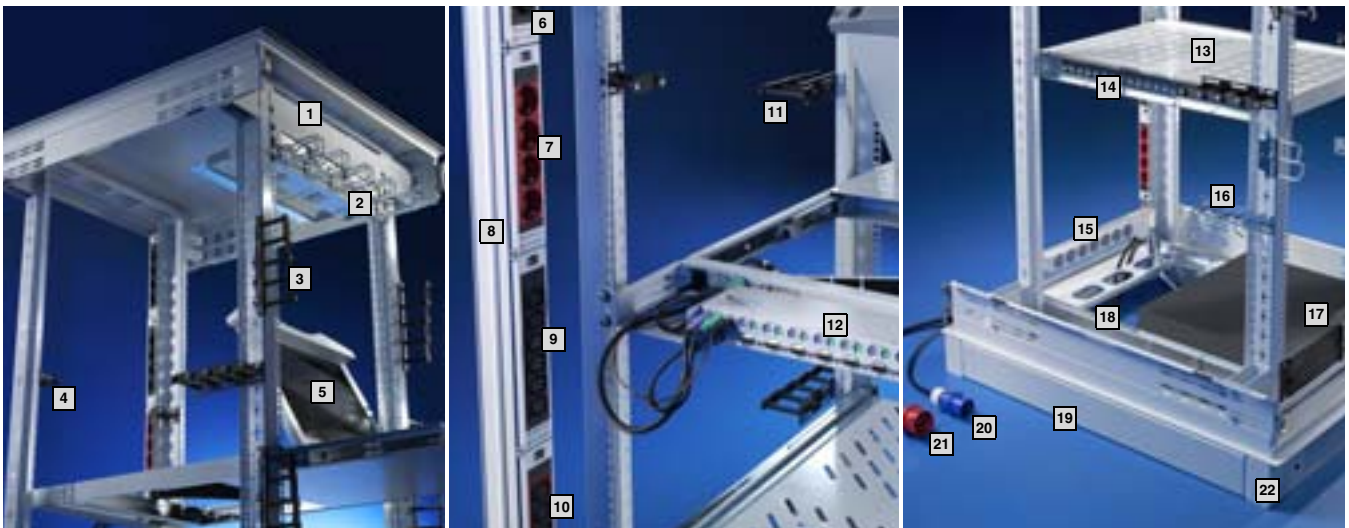

## Example: System accessories for perfect configuration of a TE 7000 server rack

Use these examples to help you.

Socket strips, lights, cable management devices and other system accessories are all available from Rittal, in a wide range of variants suitable for different applications.

- 1** Blanking panel, 482.6 mm (19"), 2 U
- 2** Cable management panel
- 3** Cable routing bar, cranked, 4 U
- 4** Cable routing bar, 1 U
- 5** Monitor/keyboard unit, 1 U
- 6** Plug-in module, PSM, earthing-pin
- 7** Plug-in module, PSM, earthing-pin, red
- 8** PSM busbar, 2000 mm
- 9** Plug-in module, PSM, IEC 320
- 10** Plug-in modules, PSM, IEC 320, red
- 11** Cable routing bar, 4 U
- 12** KVM switch SSC view 8
- 13** Component shelf, heavy duty
- 14** Mounting kit, depth-variable, for 482.6 mm (19") component shelves
- 15** Socket strip, 7-way
- 16** Distributor clip
- 17** UPS, single-phase
- 18** Slide rail, depth-variable, 1 U
- 19** Base/plinth trim, side
- 20** Connection cable, single-phase
- 21** Connection cable, three-phase
- 22** Base/plinth components, front and rear





# TE 7000 open



## Top efficiency – with free access!

The Rittal TE 7000 open offers an infinitely adjustable distance between 482.6 mm (19") levels, free airflow and a high load capacity. Because it offers free access from all sides, even extensive cable routing in central network junctions becomes child's play. The TE 7000 open allows easy, practical management of even important surplus cables.

**Note:**  
TE 7000 open,  
see page 21.

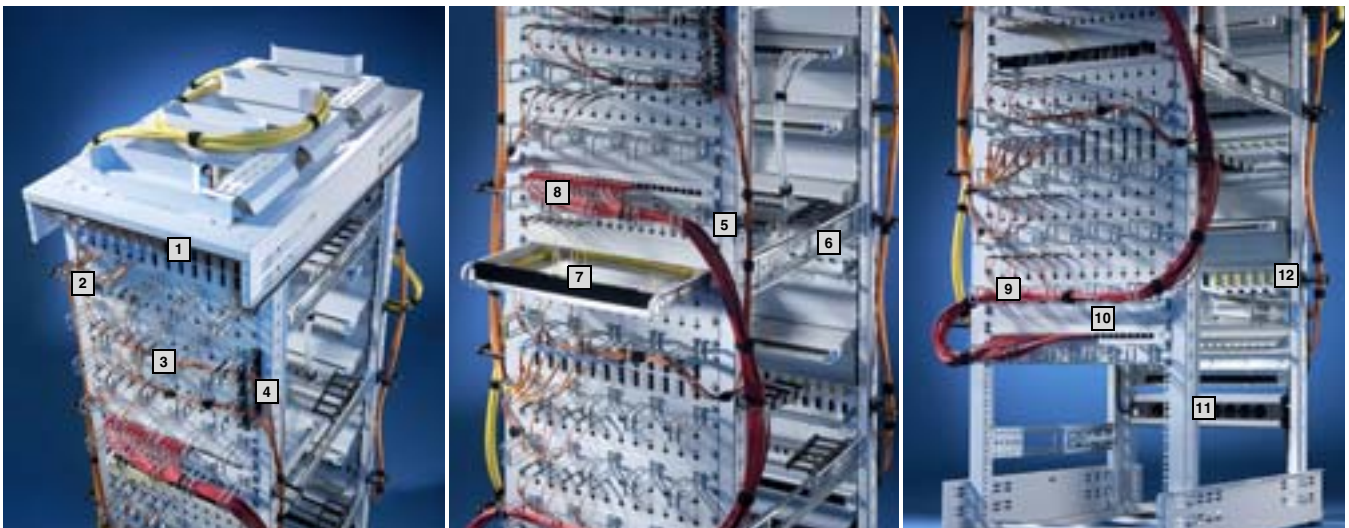

## Example: System accessories for perfect configuration of a TE 7000 open

Use these examples to help you.

Socket strips, lights, cable management devices and other system accessories are all available from Rittal, in a wide range of variants suitable for different applications.

- 1 Patch panel for SC duplex couplings
- 2 Cable management panel, 1 U
- 3 Patch panel for ST couplings
- 4 Cable routing bar, 4 U
- 5 Cable routing bar, 1 U
- 6 Depth-variable punched section with mounting flange
- 7 Drawer for surplus cables
- 8 Patch panel Cat 6
- 9 Cable management panel, 1 U
- 10 Blanking panel, 482.6 mm (19"), 1 U
- 11 TE socket strip, 8-way
- 12 Cable routing bar, 1 U





# TE 7000 in RAL 9005



## Top Efficiency – also available in black!

When function alone is not enough, the TE 7000 and many accessory components are also available in black, RAL 9005.

All the well-known positive properties of the TE 7000 are, of course, included. Be it component shelves, panels for cable routing or the monitor/keyboard unit – aesthetics and form can now be placed at the forefront, without having to compromise on function.



### Example: System accessories for perfect configuration of a TE 7000 in RAL 9005

Use these examples to help you.

Socket strips, lights, cable management devices and other system accessories are all available from Rittal, in a wide range of variants suitable for different applications.

- 1** Component shelves, heavy-duty with telescopic slides
- 2** Component shelves, unperforated, static installation
- 3** Monitor/keyboard unit, 1 U
- 4** Cable gland panel
- 5** Cable management panel
- 6** Blanking panel, 1 U

# Networking

## Network enclosures, based on Rittal TE 7000, pre-configured

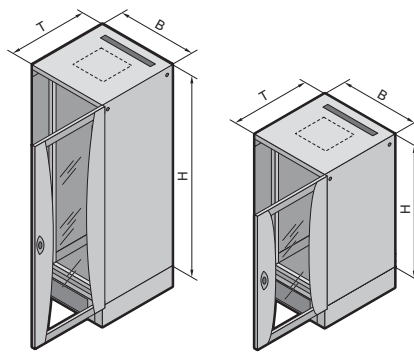

### Benefits:



- 19" mounting angles front and rear always included
- No frame structure, optimum accessibility
- Load capacity up to 400 kg, static
- Pre-configured solution, including extensive accessory kit

### Material:

Sheet steel, glazed door with 4 mm single-pane safety glass

### Surface finish:

Mounting frame: Electrophoretic dipcoat-primed  
Enclosure panels: Powder-coated, RAL 7035

	Pre-configured	Pre-configured	
			

	Pre-configured	Pre-configured	
<b>U</b>	24	42	Page
<b>Width (B) mm<sup>1)</sup></b>	800	800	
<b>Height (H) mm<sup>1)</sup></b>	1200	2000	
<b>Depth (T) mm<sup>1)</sup></b>	800	800	
Distance between 482.6 mm (19") mounting angles in its delivered state mm	495	495	
<b>Model No. TE</b>	<b>7000.840</b>	<b>7000.850</b>	
<b>Model No. TE as bayed enclosure without side panels, including baying kit</b>	–	<b>7000.852</b>	
<b>Supply includes</b>			
Self-supporting 482.6 mm (19") frame structure, depth-variable at the front and rear	■	■	
Glazed door at the front, including 130° hinge, two-point locking rod, recessed handle and security lock 3524 E	■	■	
Sheet steel door at the rear, including 130° hinge, two-point locking rod and security lock 3524 E	■	■	
Pluggable weight-reduced side panels, including security lock 3524 E	■	■ (7000.850 only)	
Base frame with maximum cut-out (for optional population with modular panels, solid, with passive ventilation or for cable entry)	■	■	
Roof plate including brush strip for cable entry and concealed cut-out for population via the active fan plate	■	■	
4 levelling feet (including base/plinth adaptor) supplied loose	■	■	
Spacers, 20 mm, supplied loose to raise the roof	■	■	
Base/plinth 100 mm, vented	■	■	
Tested frame earthing to EN 60 950, fitted	■	■	
<b>Accessory kit</b>			
4 C rails, for cable clamping in the enclosure depth via cable clamps, supplied loose	■	■	
10 cable shunting rings made of plastic, 105 x 70 mm, supplied loose	■	■	
50 captive nuts, M6, conductive, supplied loose	■	■	
50 multi-tooth screws, M6, with plastic washers, supplied loose	■	■	
<b>Accessories TE, for direct mounting in the delivered state</b>			
Ergoform-S handle for semi-cylinder, to exchange for the existing lock	2435.000	2435.000	25
Fan module, with 2 fans and thermostat, pre-wired ready for connection	7000.670	7000.670	27
Slide rail for TE, for attachment between the 482.6 mm (19") mounting frames, length 424 mm	7963.410	7963.410	33
19" component shelf for static installation, for direct screw fastening without an installation kit, 412 mm deep, load capacity 30 kg, static	7000.620	7000.620	29
Punched section with mounting flange 17 x 73 mm, for mounting installation components, attached in the enclosure depth between the 482.6 mm (19") mounting frames	8612.040	8612.040	34
C rail, for cable clamping in the enclosure depth via cable clamps	■	■	
C rail, for cable clamping in the enclosure width via cable clamps, on the 482.6 mm (19") mounting frame at the rear	7828.060	7828.060	35
Cable clamp rail, depth-variable 325 – 575 mm, for cable attachment in the enclosure depth via cable ties	7858.160	7858.160	36
Cable clamp rail for cable attachment in the enclosure depth using cable ties, on the 482.6 mm (19") mounting frame at the rear	7828.062	7828.062	35
Earthing kit for TE	■	■	
Economy socket strip, 8-way for earthing-pin plugs (German version only)	7000.630	7000.630	27

■ Included with the supply. <sup>1)</sup> All sizes are nominal dimensions. For absolute dimensions, please refer to the detailed drawing on the Internet.



## Network enclosures, based on Rittal TE 7000, width 600

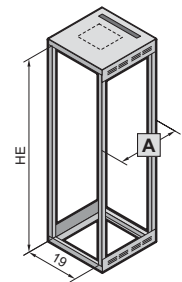
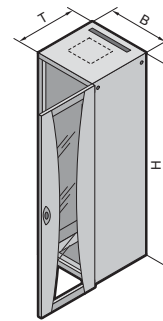

**A** = Defined mounting distance for accessories, see below.

### Benefits:

- Configured to order
- No frame structure, maximum cable routing
- Load capacity up to 400 kg, static.

### Material:

Sheet steel

### Surface finish:

Mounting frame:  
Electrophoretic dipcoat-primed  
Enclosure panels:  
Powder-coated,  
RAL 7035/RAL 9005

### Supply includes:

Self-supporting 482.6 mm (19") frame structure, glazed door at the front, two-point locking rod,

recessed handle and security lock 3524 E, sheet steel door at rear, two-point locking rod and security lock 3524 E, plug-in side panels with security lock 3524 E, base frame with maximum cut-out (for optional population with module plates), roof plate for cable entry with concealed

cut-out for fan, spacers for raising the cover plate, levelling feet.

**Detailed drawing,** available on the Internet.

	1	2	3	4	5	6	7	8	9
<b>U (HE)</b>	11	11	24	24	42	42	47	47	
<b>Width (B) mm<sup>1)</sup></b>	600	600	600	600	600	600	600	600	600
<b>Height (H) mm<sup>1)</sup></b>	600	600	1200	1200	2000	2000	2200	2200	
<b>Depth (T) mm<sup>1)</sup></b>	600	800	600	800	600	800	600	800	
Distance between 482.6 mm (19") levels as delivered <b>A</b> mm	495	495	495	495	495	495	495	495	495
<b>Model No. TE, RAL 7035</b>	<b>7000.390</b>	<b>7000.410</b>	<b>7000.430</b>	<b>7000.440</b>	<b>7000.500</b>	<b>7000.510</b>	<b>7000.560</b>	<b>7000.570</b>	
<b>Model No. TE as a bayed enclosure without side panels, incl. baying kit, RAL 7035</b>	-	-	-	-	<b>7000.502</b>	-	<b>7000.562</b>	-	
<b>Model No. TE including side panels, RAL 9005</b>	-	-	-	-	<b>7000.505<sup>2)</sup></b>	<b>7000.515<sup>2)</sup></b>	-	-	

<sup>1)</sup> All sizes given are nominal dimensions. For absolute dimensions, please refer to the detailed drawing on the Internet. <sup>2)</sup> Delivery times available on request.

**A** 495 mm – this is the distance between the two 482.6 mm (19") levels for all network enclosures in their delivered state. Complies with TS 8 nominal depth 400 mm, inner level.

**B** Pitch spacing 50 mm. The distance between the two 482.6 mm (19") levels may be varied in increments of 50 mm (445 to 695 mm).

**C** Distance from door: 52.5 mm for depth 600  
152.5 mm for depth 800

**D** The mounting distance in a rear mounting frame, horizontal, corresponds to the frame mounting dimensions of a 600 mm wide TS 8 (outer level, 512 mm).

**E** = **A** – 120 mm

The distance between levels is freely selectable via the slot fastening. All key mounting components – punched sections with mounting flanges, installation kits, slide rails, component shelves – are also available in a depth-variable version.

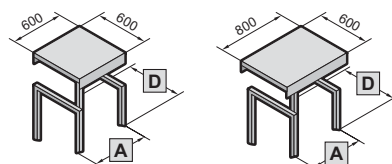

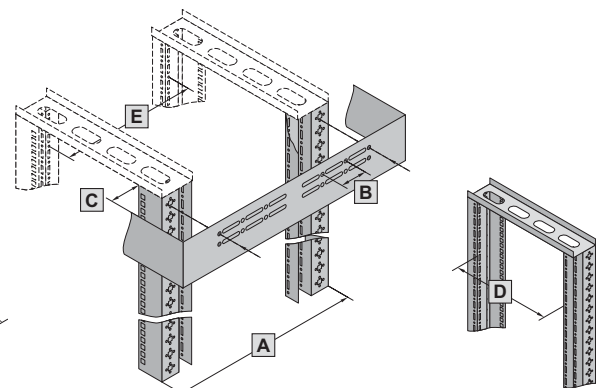

**German registered design no. 403 07 489**



# Networking

## Network enclosures, based on Rittal TE 7000, width 600

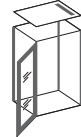
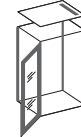

					
<b>U</b>	11	11	24	24	Page
<b>Width (B) mm<sup>1)</sup></b>	600	600	600	600	
<b>Height (H) mm<sup>1)</sup></b>	600	600	1200	1200	
<b>Depth (T) mm<sup>1)</sup></b>	600	800	600	800	
Distance between 482.6 mm (19") levels in its delivered state <b>A</b> mm	495	495	495	495	
<b>Model No. TE, RAL 7035</b>	<b>7000.390</b>	<b>7000.410</b>	<b>7000.430</b>	<b>7000.440</b>	
<b>Model No. TE as a bayed enclosure without side panels, incl. baying kit, RAL 7035</b>	-	-	-	-	
<b>Model No. TE including side panels, RAL 9005</b>	-	-	-	-	
<b>Doors</b>					
Glazed front door/sheet steel rear door	■	■	■	■	
Sheet steel front door/sheet steel rear door	on request	on request	on request	on request	
Ergoform-S handle for semi-cylinder, in exchange for the existing lock	2435.000	2435.000	2435.000	2435.000	25
<b>Side panel</b>					
Side panel, plug-type, including security lock 3524 E	■	■	■	■	25
Baying kit	7000.640	7000.640	7000.640	7000.640	25
<b>Roof</b>					
Roof plate with brush strip for cable entry, prepared to accommodate an active fan unit	■	■	■	■	
Fan unit, 2 fans (max. 3) including thermostat	7000.670	7000.670	7000.670	7000.670	27
Fan expansion kit	7980.000	7980.000	7980.000	7980.000	27
Spacers 20 mm to raise the cover plate above the fan cut-out	■	■	■	■	
<b>Base/plinth</b>					
Roof frame with maximum cut-out for individual population with module plates, levelling feet M10	■	■	■	■	
Module plate variants for individual population					24
Base/plinth, vented	7000.690	7000.691	7000.690	7000.691	23
Base/plinth trim, solid	7000.696	7000.696	7000.696	7000.696	23
Base/plinth adaptor for levelling feet M12	8800.220	8800.220	8800.220	8800.220	24
Levelling feet M12	4612.000	4612.000	4612.000	4612.000	24
<b>Internal installation/accessories</b>					
482.6 mm (19") mounting frames front and rear	■	■	■	■	
Punched section with mounting flange 17 x 73 mm, for mounting installation components, attached in the enclosure depth between the 482.6 mm (19") mounting frames	8612.040	8612.040	8612.040	8612.040	34
Cable clamp rail, depth variable 325 – 575 mm, for cable attachment in the enclosure depth using cable ties	7858.160	7858.160	7858.160	7858.160	36
Cable clamp rail, for cable attachment in the enclosure width via cable ties, on the 482.6 mm (19") mounting frame at the rear	7828.062	7828.062	7828.062	7828.062	35
C rail, for cable clamping in the enclosure depth via cable clamps	7828.040	7828.040	7828.040	7828.040	35
C rail, for cable clamping in the enclosure width via cable clamps, on the 482.6 mm (19") mounting frame at the rear	7828.060	7828.060	7828.060	7828.060	35
Earthing kit for TE	7000.675	7000.675	7000.675	7000.675	29
TE socket strip, 8-way, with earthing-pin plug	7000.630	7000.630	7000.630	7000.630	27
Power accessories	IT Catalogue, from page 328	IT Catalogue, from page 328	IT Catalogue, from page 328	IT Catalogue, from page 328	
Slide rail for TE, for attachment between the 482.6 mm (19") mounting frames, length 424 mm	7963.410	7963.410	7963.410	7963.410	33
482.6 mm (19") component shelf for static installation, for direct screw-fastening without installation kit, 412 mm deep, load capacity 30 kg, static	7000.620	7000.620	7000.620	7000.620	29
Cable management					34
CMC-TC monitoring system	IT Catalogue, from page 158	IT Catalogue, from page 158	IT Catalogue, from page 158	IT Catalogue, from page 158	

■ Included with the supply.

<sup>1)</sup> All sizes given are nominal dimensions. For absolute dimensions, please refer to the detailed drawing on the Internet.

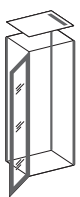

## Network enclosures, based on Rittal TE 7000, width 600

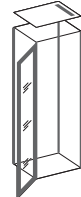
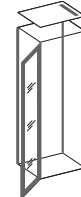
					
<b>U</b>	42	42	47	47	Page
<b>Width (B) mm<sup>1)</sup></b>	600	600	600	600	
<b>Height (H) mm<sup>1)</sup></b>	2000	2000	2200	2200	
<b>Depth (T) mm<sup>1)</sup></b>	600	800	600	800	
Distance between 482.6 mm (19") levels in its delivered state <b>A</b> mm	495	495	495	495	
<b>Model No. TE, RAL 7035</b>	<b>7000.500</b>	<b>7000.510</b>	<b>7000.560</b>	<b>7000.570</b>	
<b>Model No. TE as a bayed enclosure without side panels, incl. baying kit, RAL 7035</b>	<b>7000.502</b>	–	<b>7000.562</b>	–	
<b>Model No. TE including side panels, RAL 9005</b>	<b>7000.505<sup>2)</sup></b>	<b>7000.515<sup>2)</sup></b>	–	–	
<b>Doors</b>					
Glazed front door/sheet steel rear door	■	■	■	■	
Sheet steel front door/sheet steel rear door	on request	on request	on request	on request	
Ergoform-S handle for semi-cylinder, in exchange for the existing lock	2435.000	2435.000	2435.000	2435.000	25
<b>Side panel</b>					
Side panel, plug-type, including security lock 3524 E	■ (7000.500, 7000.505 only)	■	■ (7000.560 only)	■	25
Baying kit	■ (7000.502 only)	7000.640	■ (7000.562 only)	7000.640	25
<b>Roof</b>					
Roof plate with brush strip for cable entry, prepared to accommodate an active fan unit	■	■	■	■	
Fan unit, 2 fans (max. 3) including thermostat	7000.670	7000.670	7000.670	7000.670	27
Fan expansion kit	7980.000	7980.000	7980.000	7980.000	27
Spacers 20 mm to raise the cover plate above the fan cut-out	■	■	■	■	
<b>Base/plinth</b>					
Roof frame with maximum cut-out for individual population with module plates, levelling feet M10	■	■	■	■	
Module plate variants for individual population					24
Base/plinth, vented	7000.690	7000.691	7000.690	7000.691	23
Base/plinth trim, solid	7000.696	7000.696	7000.696	7000.696	23
Base/plinth adaptor for levelling feet M12	8800.220	8800.220	8800.220	8800.220	24
Levelling feet M12	4612.000	4612.000	4612.000	4612.000	24
<b>Internal installation/accessories</b>					
482.6 mm (19") mounting frames front and rear	■	■	■	■	
Punched section with mounting flange 17 x 73 mm, for mounting installation components, attached in the enclosure depth between the 482.6 mm (19") mounting frames	8612.040	8612.040	8612.040	8612.040	34
Cable clamp rail, depth variable 325 – 575 mm, for cable attachment in the enclosure depth using cable ties	7858.160	7858.160	7858.160	7858.160	36
Cable clamp rail, for cable attachment in the enclosure width via cable ties, on the 482.6 mm (19") mounting frame at the rear	7828.062	7828.062	7828.062	7828.062	35
C rail, for cable clamping in the enclosure depth via cable clamps	7828.040	7828.040	7828.040	7828.040	35
C rail, for cable clamping in the enclosure width via cable clamps, on the 482.6 mm (19") mounting frame at the rear	7828.060	7828.060	7828.060	7828.060	35
Earthing kit for TE	7000.675	7000.675	7000.675	7000.675	29
TE socket strip, 8-way, with earthing-pin plug	7000.630	7000.630	7000.630	7000.630	27
Power accessories	IT Catalogue, from page 328	IT Catalogue, from page 328	IT Catalogue, from page 328	IT Catalogue, from page 328	
Slide rail for TE, for attachment between the 482.6 mm (19") mounting frames, length 424 mm	7963.410	7963.410	7963.410	7963.410	33
482.6 mm (19") component shelf for static installation, for direct screw fastening without an installation kit, 412 mm deep, load capacity 30 kg, static	7000.620	7000.620	7000.620	7000.620	29
Cable management					34
CMC-TC monitoring system	IT Catalogue, from page 158	IT Catalogue, from page 158	IT Catalogue, from page 158	IT Catalogue, from page 158	

■ Included with the supply.

<sup>1)</sup> All sizes given are nominal dimensions. For absolute dimensions, please refer to the detailed drawing on the Internet.

<sup>2)</sup> Delivery times available on request.

# Networking

## Network enclosures, based on Rittal TE 7000, width 800

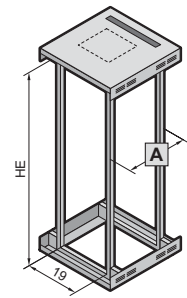
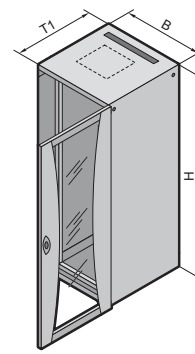

**A** = Defined mounting distance for accessories, see below.

### Benefits:

- Configured to order
- No frame structure, maximum cable routing
- Load capacity up to 400 kg, static

### Material:

Sheet steel

### Surface finish:

Mounting frame: Electrophoretic dipcoat-primed  
Enclosure panels: Powder-coated, RAL 7035/RAL 9005

### Supply includes:

Self-supporting 482.6 mm (19") frame structure, glazed door at the front,

two-point locking rod, recessed handle and security lock 3524 E, sheet steel door at rear, two-point locking rod and security lock 3524 E, plug-in side panels with security lock 3524 E, base frame with maximum cut-out (for optional population with module plates), roof plate for cable entry with concealed

cut-out for fan, levelling feet, spacers for raising the cover plate.

**Detailed drawing,** available on the Internet.

<b>U (HE)</b>	24	24	42	42	47	47
<b>Width (B) mm<sup>1)</sup></b>	800	800	800	800	800	800
<b>Height (H) mm<sup>1)</sup></b>	1200	1200	2000	2000	2200	2200
<b>Depth (T) mm<sup>1)</sup></b>	600	800	600	800	600	800
Distance between 482.6 mm (19") levels in its delivered state <b>A</b> mm	495	495	495	495	495	495
<b>Model No. TE, RAL 7035</b>	<b>7000.450</b>	<b>7000.460</b>	<b>7000.520</b>	<b>7000.530</b>	<b>7000.580</b>	<b>7000.590</b>
<b>Model No. TE as bayed enclosure without side panels, including baying kit, RAL 7035</b>	-	-	-	<b>7000.532</b>	-	<b>7000.592</b>
<b>Model No. TE including side panels, RAL 9005</b>	-	-	<b>7000.525<sup>2)</sup></b>	<b>7000.535<sup>2)</sup></b>	-	-

<sup>1)</sup> All sizes given are nominal dimensions. For absolute dimensions, please refer to the detailed drawing on the Internet. <sup>2)</sup> Delivery times available on request.

**A** 495 mm – This is the distance between the two 482.6 mm (19") levels for all network enclosures in their delivered state. Complies with TS 8 nominal depth 400 mm, inner level.

**B** Pitch spacing 50 mm. The distance between the two 482.6 mm (19") levels may be varied in increments of 50 mm (445 to 695 mm).

**C** Distance from door: 52.5 mm for depth 600  
152.5 mm for depth 800

**D** The mounting distance in a rear mounting frame, horizontal, corresponds to the frame mounting dimensions of a 600 mm wide TS 8 (outer level, 512 mm).

**E** = **A** – 120 mm

The distance between levels is freely selectable via the slot fastening. All key mounting components – punched sections with mounting flanges, installation kits, slide rails, component shelves – are also available in a depth-variable version.

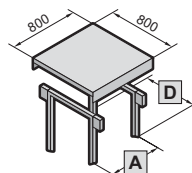
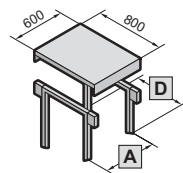

**German registered design no. 403 07 489**

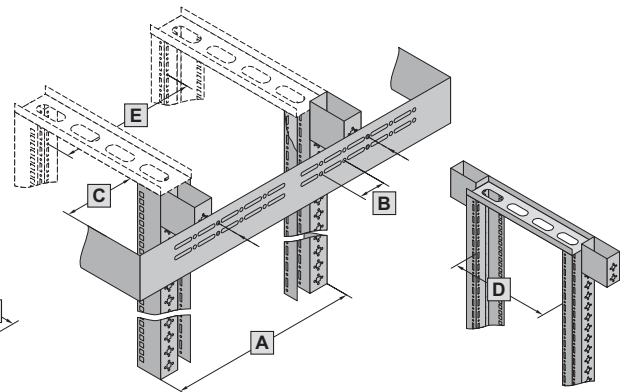



## Network enclosures, based on Rittal TE 7000, width 800

<b>U (HE)</b>	24	24	42	42	47	47	Page
<b>Width (B) mm<sup>1)</sup></b>	800	800	800	800	800	800	
<b>Height (H) mm<sup>1)</sup></b>	1200	1200	2000	2000	2200	2200	
<b>Depth (T) mm<sup>1)</sup></b>	600	800	600	800	600	800	
Distance between 482.6 mm (19") levels in its delivered state <b>A</b> mm	495	495	495	495	495	495	
<b>Model No. TE, RAL 7035</b>	<b>7000.450</b>	<b>7000.460</b>	<b>7000.520</b>	<b>7000.530</b>	<b>7000.580</b>	<b>7000.590</b>	
<b>Model No. TE as a bayed enclosure without side panels, incl. baying kit, RAL 7035</b>	–	–	–	<b>7000.532</b>	–	<b>7000.592</b>	
<b>Model No. TE including side panels, RAL 9005</b>	–	–	<b>7000.525<sup>2)</sup></b>	<b>7000.535<sup>2)</sup></b>	–	–	
<b>Doors</b>							
Glazed front door/sheet steel rear door	■	■	■	■	■	■	
Sheet steel front door/sheet steel rear door	on request	on request	on request	on request	on request	on request	
Ergoform-S handle for semi-cylinder, in exchange for the existing lock	2435.000	2435.000	2435.000	2435.000	2435.000	2435.000	25
<b>Side panel</b>							
Side panel, plug-type, including security lock 3524 E	■	■	■	■ (7000.530, 7000.535 only)	■	■ (7000.590 only)	25
Baying kit	7000.640	7000.640	7000.640	■ (7000.532 only)	7000.640	■ (7000.592 only)	25
<b>Roof</b>							
Roof plate with brush strip for cable entry, prepared to accommodate an active fan unit	■	■	■	■	■	■	
Fan unit, 2 fans (max. 3) including thermostat	7000.670	7000.670	7000.670	7000.670	7000.670	7000.670	27
Fan expansion kit	7980.000	7980.000	7980.000	7980.000	7980.000	7980.000	27
Spacers 20 mm to raise the cover plate above the fan cut-out	■	■	■	■	■	■	
<b>Base/plinth</b>							
Roof frame with maximum cut-out for individual population with module plates, levelling feet M10	■	■	■	■	■	■	
Module plate variants for individual population							24
Base/plinth, vented	7000.693	7000.694	7000.693	7000.694	7000.693	7000.694	23
Base/plinth trim, solid	7000.698	7000.698	7000.698	7000.698	7000.698	7000.698	23
Base/plinth adaptor for levelling feet M12	8800.220	8800.220	8800.220	8800.220	8800.220	8800.220	24
Levelling feet M12	4612.000	4612.000	4612.000	4612.000	4612.000	4612.000	24
<b>Internal installation/accessories</b>							
482.6 mm (19") mounting frames front and rear	■	■	■	■	■	■	
Punched section with mounting flange 17 x 73 mm, for mounting installation components, attached in the enclosure depth between the 482.6 mm (19") mounting frames	8612.040	8612.040	8612.040	8612.040	8612.040	8612.040	34
Cable clamp rail, depth variable 325 – 575 mm, for cable attachment in the enclosure depth using cable ties	7858.160	7858.160	7858.160	7858.160	7858.160	7858.160	36
Cable clamp rail, for cable attachment in the enclosure width via cable ties, on the 482.6 mm (19") mounting frame at the rear	7828.062	7828.062	7828.062	7828.062	7828.062	7828.062	35
C rail, for cable clamping in the enclosure depth via cable clamps	4943.000	4943.000	4943.000	4943.000	4943.000	4943.000	35
C rail, for cable clamping in the enclosure width via cable clamps, on the 482.6 mm (19") mounting frame at the rear	7828.060	7828.060	7828.060	7828.060	7828.060	7828.060	35
Earthing kit for TE	7000.675	7000.675	7000.675	7000.675	7000.675	7000.675	29
TE socket strip, 8-way, with earthing-pin plug	7000.630	7000.630	7000.630	7000.630	7000.630	7000.630	27
Power accessories	IT Catalogue, from page 328	IT Catalogue, from page 328	IT Catalogue, from page 328	IT Catalogue, from page 328	IT Catalogue, from page 328	IT Catalogue, from page 328	
Slide rail for TE, for attachment between the 482.6 mm (19") mounting frames, length 424 mm	7963.410	7963.410	7963.410	7963.410	7963.410	7963.410	33
482.6 mm (19") component shelf for static installation, for direct screw fastening without an installation kit, 412 mm deep, load capacity 30 kg, static	7000.620	7000.620	7000.620	7000.620	7000.620	7000.620	29
Cable management							34
CMC-TC monitoring system	IT Catalogue, from page 158	IT Catalogue, from page 158	IT Catalogue, from page 158	IT Catalogue, from page 158	IT Catalogue, from page 158	IT Catalogue, from page 158	

■ Included with the supply.

<sup>1)</sup> All sizes given are nominal dimensions. For absolute dimensions, please refer to the detailed drawing on the Internet. <sup>2)</sup> Delivery times available on request.

# Networking

## Network enclosures, based on Rittal TE 7000, metric attachment levels

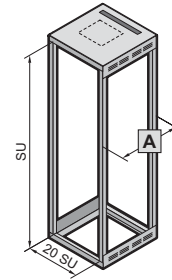
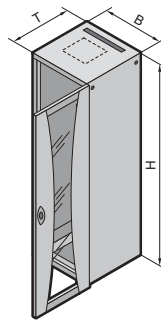

### Benefits:

- Configured to order
- No frame structure, maximum cable routing
- Load capacity up to 400 kg, static

### Material:

Sheet steel

### Surface finish:

Nanoceramic-coating, electrophoretic dipcoat-priming, powder-coating in RAL 7035

### Supply includes:

Self-supporting metric frame structure, glazed door at the front, two-point locking rod, recessed handle and security lock 3524 E,

sheet steel door at the rear, two-point locking rod and security lock 3524 E, plug-in side panels with security lock 3524 E, base frame with maximum cut-out (for optional population with module plates), roof plate for cable entry with concealed cut-out for fan,

spacers for raising the cover plate, levelling feet.

**Detailed drawing,** available on the Internet.

<b>SU</b>	76	82
<b>Width (B) mm<sup>2)</sup></b>	600	600
<b>Height (H) mm<sup>2)</sup></b>	2000	2200
<b>Depth (T) mm<sup>2)</sup></b>	600	600
Distance between metric levels in its delivered state <b>A</b> mm	495	495
<b>Model No. TE</b>	<b>7000.508<sup>1)</sup></b>	<b>7000.568<sup>1)</sup></b>
<b>Model No. TE as bayed enclosure without side panels, including baying kit</b>	<b>7000.504<sup>1)</sup></b>	<b>7000.564<sup>1)</sup></b>

<sup>1)</sup> Delivery times on request. <sup>2)</sup> All sizes given are nominal dimensions. For absolute dimensions, please refer to the detailed drawing on the Internet.

**A** 495 mm – This is the distance between the two metric levels for all networking enclosures in their delivered state. Complies with TS 8 nominal depth 400 mm, inner level. The distance between levels is freely selectable via the slot fastening.

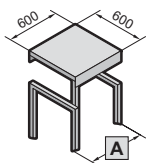

### Size systems

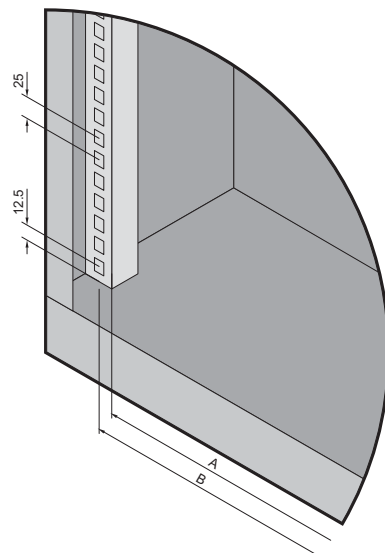

### Explanation of the mounting dimensions Interior installation

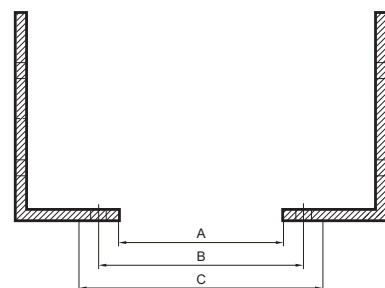

Installation width	A mm	B mm	C mm
20 SU	500	515	535

A = Clearance width  
 B = Mounting dimension  
 C = External dimension of slide-in equipment or front panel



## TE 7000 open

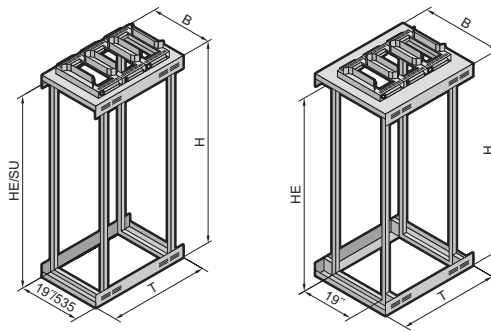

$$HE = U$$

### Benefits:

Unlimited applications covering all tasks in the IT sector. Both as a network distribution frame with maximum accessibility from all sides for assembly and installation, and as a server rack with a high load capacity of up to 700 kg, static. Unrestricted air-flow, due to the open design. The standard cable trays in the roof area mean that even large

quantities of cables are easily routed to the various levels without kinks.

In a bayed configuration, the 800 mm width in particular offers plenty of space for cable routing between units.

There is an extensive range of accessories available for individual cable management solutions. The distance between attachment levels is infinitely variable.

### Material:

Sheet steel

### Surface finish:

Powder-coated, RAL 7035

### Load capacity:





700 kg, static

### Supply includes:

Self-supporting frame structure, with a 482.6 mm (19") or metric attachment level front and rear depending on the design.

Open roof frame for cable entry, 3 cable routing trays. Open base frame with 2 punched sections with mounting flanges for individual configuration in the width, levelling feet.

**Detailed drawing,** available on the Internet.

								
<b>U/SU</b>	42/-	42/-	42/76	47/82	42/-	47/-		Page
<b>Width (B) mm</b>	600	800	600	600	800	800		
<b>Height<sup>3)</sup> (H) mm</b>	2000	2000	2000	2200	2000	2200		
<b>Depth (T) mm</b>	800	800	1000	1000	1000	1000		
Distance between levels as delivered mm	495	495	745	745	745	745		
<b>Model No. TE with 482.6 mm (19") attachment level</b>	<b>7000.930</b>	<b>7000.934</b>	<b>7000.940</b>	<b>7000.942<sup>1)</sup></b>	<b>7000.944</b>	<b>7000.946<sup>1)</sup></b>		
<b>Model No. TE with metric (535 mm) attachment level</b>	-	-	<b>7000.960<sup>1)</sup></b>	<b>7000.962<sup>1)</sup></b>	-	-		
<b>482.6 mm (19") accessories</b>	Packs of							
Cable management panel 482.6 mm (19"), 1 U for horizontal cable routing, with 5 steel rings, zinc-plated passivated, size 100 x 37 mm	1	7257.035	7257.035	7257.035	7257.035	7257.035	7257.035	38
Cable management panel 482.6 mm (19"), 2 U for horizontal cable routing, with 5 steel rings, zinc-plated passivated, size 120 x 80 mm	1	7257.100	7257.100	7257.100	7257.100	7257.100	7257.100	38
Shunting rings to accommodate large quantities of cables, for mounting on the side of the mounting frame, dimension 300 x 90 mm	2	7220.600	7220.600	7220.600	7220.600	7220.600	7220.600	39
Cable management panel 482.6 mm (19"), 2 U for horizontal cable routing, with removable front panel	1	7158.100	7158.100	7158.100	7158.100	7158.100	7158.100	38
Component shelf 482.6 mm (19"), 1/2 U static installation, depth-variable	1	7063.710 <sup>2)</sup>	7063.710 <sup>2)</sup>	7063.720 <sup>2)</sup>	7063.720 <sup>2)</sup>	7063.720	7063.720	29
Slide rail 482.6 mm (19"), load capacity 100 kg, static for distance between 482.6 mm (19") levels (internal) 740 mm	2	-	-	7063.740 <sup>2)</sup>	7063.740 <sup>2)</sup>	7063.740	7063.740	33
Slide rail 482.6 mm (19"), depth-variable in the range from 590 - 930 mm, load capacity 80 kg, static	2	7063.882 <sup>2)</sup>	7063.882 <sup>2)</sup>	7063.883 <sup>2)</sup>	7063.883 <sup>2)</sup>	7063.883	7063.883	33
C rail, variable within the range 450 - 850 mm	1	7016.140	7016.140	7016.140	7016.140	7016.140	7016.140	37
T-head rail, variable within the range 450 - 850 mm	1	7016.150	7016.150	7016.150	7016.150	7016.150	7016.150	37
Cable route for vertical cable management, for mounting at the side rear of the 482.6 mm (19") mounting frame, B = 100 mm, H = 1700 mm	1 set	7000.685	7000.685	7000.685	7000.685	7000.685	7000.685	40

<sup>1)</sup> Delivery times available on request.

<sup>2)</sup> Not suitable for use with a metric attachment level.

<sup>3)</sup> Plus 100 mm roof-mounting/cable-routing trays.

# Server racks

## Based on Rittal TE 7000, 1000 mm deep

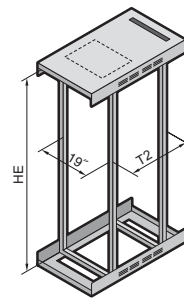
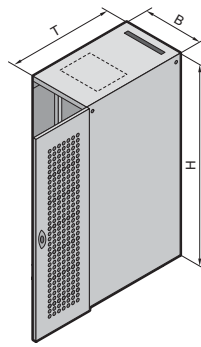

**A** = Defined mounting distance for accessories, see below.

### Benefits:

- No frame structure, optimum accessibility

### Static load capacity:

700 kg

### Material:

Sheet steel

### Surface finish:

Mounting frame:  
Dipcoat-primed  
Enclosure panels:  
Powder-coated, RAL 7035/9005

### Supply includes:

Self-supporting 482.6 mm (19") frame structure, vented sheet steel door front and rear, two-point locking rod, recessed handle (front) and security lock 3524 E,

roof plate with brush strip for cable entry and concealed cut-out for fan integration, levelling feet.

**Detailed drawing,** available on the Internet.

<b>U (HE)</b>		42	42	42	42	Page
<b>Width (B) mm<sup>1)</sup></b>		600	600	800	800	
<b>Height (H) mm<sup>1)</sup></b>		2000	2000	2000	2000	
<b>Depth (T) mm<sup>1)</sup></b>		1000	1000	1000	1000	
Distance between 482.6 mm (19") levels in its delivered state <b>A</b> mm		745	745	745	745	
<b>Model No. TE as bayed enclosure without side panels, including baying kit</b>	RAL 7035	<b>7000.882</b>	–	<b>7000.892</b>	–	
	RAL 9005	–	<b>7000.885</b>	–	<b>7000.895</b>	
<b>Doors</b>						
Sheet steel door front and rear, fully vented, open surface area > 67 % perforated		■	■	■	■	
<b>Roof</b>						
Roof plate including brush strip for cable entry and with an optional fan		■	■	■	■	
<b>Base</b>						
Base frame with maximum cut-out for cable entry or passive ventilation, can be fitted with optional blanking panels		■	■	■	■	
<b>Interior installation</b>						
482.6 mm (19") mounting frames front and rear		■	■	■	■	
<b>Accessories</b>						
Side panels, pluggable, including security lock 3524 E	7000.653	7000.663	7000.653	7000.663	25	
Ergoform-S handle for semi-cylinder, in exchange for the existing lock	2435.000	2452.000 <sup>2)</sup>	2435.000	2452.000 <sup>2)</sup>	25	
Fan unit, with 2 fans and thermostat, pre-wired ready for connection	7000.670	7000.671 <sup>3)</sup>	7000.670	7000.671 <sup>3)</sup>	27	
Transport castors, 4 castors including assembly parts	7000.672	7000.672	7000.672	7000.672	23	
C rail, for cable clamping in the enclosure width via cable clamps, on the 482.6 mm (19") mounting frame at the rear	7828.060	7828.060	7828.060	7828.060	35	
Cable clamp rail, depth variable 500 – 895 mm, for cable attachment in the enclosure depth using cable ties	7858.162	7858.162	7858.162	7858.162	36	
Cable clamp rail for cable attachment in the enclosure width via cable ties, on the 482.6 mm (19") mounting frame at the rear	7828.062	7828.062	7828.062	7828.062	35	
Earthing kit for TE	7000.675	7000.675	7000.675	7000.675	29	
TE socket strip, 8-way for earthing-pin plugs	7000.630	7000.630	7000.630	7000.630	27	

■ Included with the supply. <sup>1)</sup> All sizes are nominal dimensions. For absolute dimensions, refer to detailed drawings on the Internet. <sup>2)</sup> Matt nickel-plated. <sup>3)</sup> Delivery times available on request.



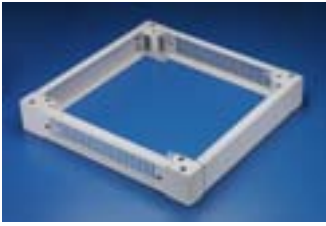

## Base/plinth, vented

### for TE 7000

For easier cable routing between bayed enclosure systems or as additional storage space beneath the enclosure, this vented complete base/plinth is easily screw-fastened underneath. The trim panels may be removed on all sides to allow cable routing in all directions.

**Base/plinth height:**  
100 mm

**Material:**  
Sheet steel, spray-finished

**Colour:**  
RAL 7035/9005

**Supply includes:**  
1 base/plinth, vented  
including assembly parts.



For enclosures		Colour RAL	Model No. DK
Width mm	Depth mm		
600	1000	9005	<b>7000.686</b>
800	1000	9005	<b>7000.687</b>
600	600	7035	<b>7000.690</b>
600	800	7035	<b>7000.691</b>
600	1000	7035	<b>7000.692</b>
800	600	7035	<b>7000.693</b>
800	800	7035	<b>7000.694</b>
800	1000	7035	<b>7000.695</b>

### + Accessories:

Filter mat for base/plinth, vented,  
600 mm wide DK 7561.500 and  
800 mm wide DK 7581.500,  
see IT Catalogue, page 258.



## Base/plinth trim, solid

### for base/plinth, vented

To be used in exchange for the existing trim panel.

If a solid design is required for the base/plinth for TE, the vented front and rear trim panels should be exchanged for solid trim panels.

**Material:**  
Sheet steel, spray-finished

**Colour:**  
RAL 7035

**Supply includes:**  
2 base/plinth trim panels  
including assembly parts.

For enclosure width mm	Colour RAL	Model No. DK
600	7035	<b>7000.696</b>
800	7035	<b>7000.698</b>



## Transport castors

### for TE

For easy transportation between sites. The castors may be screw-fastened in the corner areas within the base frame in place of the levelling feet. Ground clearance: 58 mm, mounting thread M10 x 20

**Permissible static load:**  
300 kg per enclosure

Packs of	Model No. TE
1 set	<b>7000.672</b>

**Supply includes:**  
1 set = 4 castors  
including assembly parts.

# System accessories

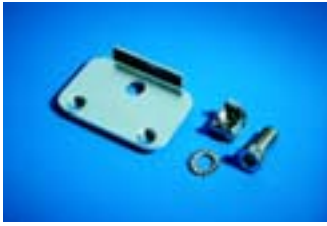

## Base/plinth adaptor for levelling feet

Connection component for fastening M12 levelling feet PS 4612.000 to the TS base/plinth and base/plinth, vented, for TE.

**Material:**  
Sheet steel, zinc-plated, passivated

Packs of	<b>Model No. TS</b>
4	<b>8800.220</b>

**! Also required:**

Levelling feet PS 4612.000, see page 24.



## Levelling feet 18 – 43 mm high

To compensate for height differences with floor irregularities. Thread length 40 mm. Assembly thread M12.

Maximum permissible static load: approx. 300 kg per levelling foot.

- For:**
- Baying system TS 8
  - PC enclosure system
  - Pedestal base plate CP 6137.035 – CP 6137.535
  - Pedestal CP 6141.XXX
  - Industrial workstations
  - flexRack(i)
  - TE

Packs of	<b>Model No. PS</b>
4	<b>4612.000</b>

**! Also required:**

For mounting on the TS base/plinth and base/plinth, vented, for TE:  
Base/plinth adaptor TS 8800.220, see page 24.

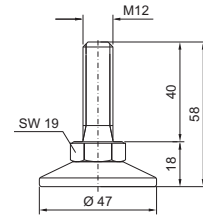

## Module plates for TE

The base area of the TE may be varied as required using the module plates.

**Material:**  
Sheet steel

**Supply includes:**  
Assembly parts.

Version	Width mm	Depth mm	<b>Model No. TE</b>
Solid	450	200	<b>7526.760</b>
	450	550	<b>7526.770</b>
	450	750	<b>7526.780</b>
	650	550	<b>7526.785</b>
	650	200	<b>7526.800</b>
With brush strip	650	750	<b>7526.820</b>
	450	200	<b>7526.850</b>
Vented	650	200	<b>7526.860</b>
	450	200	<b>7526.829</b>
Compensating panel	650	200	<b>7526.834</b>
	450	50	<b>7526.750</b>
	450	150	<b>7526.755</b>
	650	50	<b>7526.790</b>
	650	150	<b>7526.795</b>

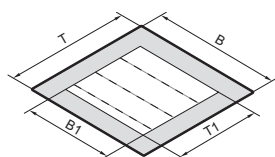

Enclosure dimensions mm	B	600	600	600	800	800	800
	T	600	800	1000	600	800	1000
Base cut-out dimensions mm	B1	450	450	450	650	650	650
	T1	550	750	950	550	750	950

B = Width  
T = Depth



## Side panels

### for TE

To finish off individual racks or entire bayed suites of racks at the sides.

The side panels are simply located and secured with the integral lock.

The super-lightweight design means that it is easily handled by one person.

### Material:

Sheet steel, powder-coated

### Colour:

RAL 7035/RAL 9005

### Protection category:

IP 20

### Supply includes:

Security lock 3524 E.

For enclosures			Model No. TE	
Height mm	Depth mm	Packs of	RAL 7035	RAL 9005
1200	600	2	<b>7000.642</b>	–
1200	800	2	<b>7000.644</b>	–
2000	600	2	<b>7000.650</b>	–
2000	800	2	<b>7000.652</b>	–
2000	1000	2	<b>7000.653</b>	<b>7000.633<sup>1)</sup></b>
2200	600	2	<b>7000.654</b>	–
2200	800	2	<b>7000.656</b>	–

<sup>1)</sup> Delivery times available on request.



## Baying kit

### for TE/TE

For connecting individual enclosures into bayed suites at the sides. The enclosures are connected between the base and roof frame.

### Material:

Sheet steel, zinc-plated, passivated

### Supply includes:

Assembly parts.

Packs of	Model No. TE
4	<b>7000.640</b>



## The Ergoform-S lock system

The unlocked handle folds down forwards, and the lock is opened by swivelling.

### Material:

Die-cast zinc

### Surface finish:

Powder-coated



## Ergoform standard

Prepared for the installation of semi-cylinders with a total length of 40 or 45 mm (to DIN 18 252), see page 26, all 27 mm lock inserts, version A, see page 26, as well as SZ lock and push-button inserts, see page 26.

Version	Model No. SZ
RAL 7032 with brown handle	<b>2450.000</b>
Brown	<b>2451.000</b>
Matt nickel-plated	<b>2452.000</b>
RAL 7032	<b>2454.000</b>
RAL 7035	<b>2435.000</b>
RAL 7032 <sup>1)</sup> with brown handle and bracket	<b>2455.000</b>

<sup>1)</sup> Hole diameter = 7 mm for padlock





## Lock and push-button inserts

For installation in

- Comfort handle for semi-cylinder, see IT Catalogue, page 282
- Ergoform-S standard, see page 25
- Folding lever handle for CM, see Cat. 32, page 949.

Version	Model No. SZ
Lock insert no. 3524 E	2467.000 <sup>1)</sup>
Push-button insert	2468.000
Lock and push-button insert, lock no. 2123 E; No other lock is possible	2469.000 <sup>1)</sup>

<sup>1)</sup> with 2 keys

### Possible alternative:

Semi-cylinder, see page 26.



## Lock inserts

Version A

**Material:**  
Die-cast zinc

Length 27 mm	Model No. SZ
7 mm square	2460.000
8 mm square	2461.000
7 mm triangular	2462.000
8 mm triangular	2463.000
Screwdriver	2464.000
Daimler insert	2465.000
3 mm double-bit	2466.000
Fiat	2307.000
6.5 mm triangular (CNOMO)	2460.650



## Semi-cylinder

to DIN 18 252

40 mm, alternative closure, for individual locks in handle systems with cylinder insert.

**Supply includes:**  
3 keys.

Packs of	Model No. CS
1 set	9785.040

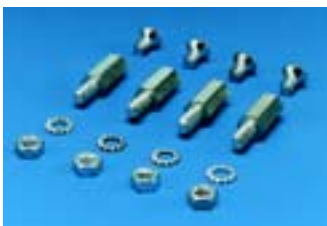

## Spacers

for cover plates TE

To assist passive ventilation, spacers may be used to raise the cover plate.

**Material:**  
Hexagonal sectional steel, zinc-plated, passivated.

**Supply includes:**  
Assembly parts.

Height mm	Packs of	Model No. TE
20	4	7526.963

### **Note:**

Spacers are already included with the supply of the TE enclosures.



## Fan unit, active

### for TE

For active ventilation of the TE 7000. The fan unit is installed in the prepunched cut-out. An additional fan may optionally be integrated.

### Supply includes:

Fan unit including assembly parts, 2 fans, 1 thermostat and open connection cable.

### Technical specifications for one fan:

Fan expansion kit DK 7980.000, see page 27.

### Technical specifications of thermostat:

Rated operating voltage: 250 V  
Temperature range: +5°C to +55°C

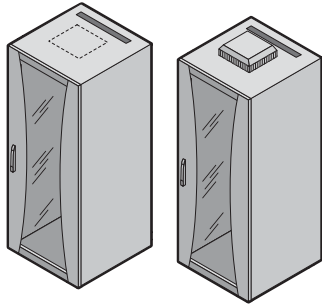

## Active kit

### for TE

Consisting of fan unit including thermostat, fully wired ready for connection, socket strip (DK 7000.630) for up to 8 earthing-pin plugs, version D and connection cable (DK 7200.210).

For enclosures W x D mm	No. of pre-wired fans	No. of fans supported	Model No. TE	
			RAL 7035	RAL 9005
All dimensions	2	3	<b>7000.670</b>	<b>7000.671</b>

### Note:

Connection via distributor box or country-specific connector.



### Accessories:

Fan expansion kit, see page 27.

Packs of	Model No. DK
1 set	<b>7000.680</b>



## Fan expansion kit

For retro-fitting various fan units or to supplement the fan mounting plate and modular fan roof.

### Technical specifications DK 7980.000:

Rated operating voltage: 230 V~  
Power consumption: 15/14 W at 50/60 Hz  
Air throughput (unimpeded air flow): 160/180 m<sup>3</sup>/h, 50/60 Hz  
Noise level (unimpeded air flow): 37 dB (A)  
Temperature range: -10°C to +55°C

### Technical specifications DK 7980.100:

Rated operating voltage: 230 V~  
Power consumption: 14/12 W at 50/60 Hz  
Air throughput (unimpeded air flow): 108/120 m<sup>3</sup>/h, 50/60 Hz  
Noise level (unimpeded air flow): 34 dB (A)  
Temperature range: -20°C to +70°C

### Technical specifications DK 7980.148:

Rated operating voltage: 48 V (DC)  
Power consumption: 7.7 W  
Air throughput (unimpeded air flow): 184 m<sup>3</sup>/h  
Noise level (unimpeded air flow): 43 dB (A)  
Temperature range: -20°C to +70°C

Dimensions W x H x D mm	Packs of	Model No. DK
119 x 119 x 38	1 set	<b>7980.000</b>
119 x 119 x 25	1 set	<b>7980.100</b>
119 x 119 x 25	1 set	<b>7980.148</b>

### Supply includes:

Fan, including assembly parts and connection cable (0.61 m).



## Socket strip TE

8-way socket strip for earthing-pin plug/version D. The strip is made of plastic and may be mounted vertically on the TE frame or in the rear 482.6 mm (19") section. In the 482.6 mm (19") section, more than 2 U of space is required. The sockets are arranged at an angle of 45° so that angular connectors are also easily used. The socket strip is supplied with a 2 m connection cable. The connection cable is attached in a terminal raceway in the strip.

The terminal raceway is equipped with a separate cover, so that this connection point can always be quickly and easily accessed. The connection cable is likewise easily replaced. Furthermore, the socket strip has external terminals for separate earthing.

Socket strip TE	Model No. DK
8-way, earthing-pin	<b>7000.630</b>

### Technical specifications:

Rated voltage: 230 Volt AC  
Rated current: Max. 16 A  
Connection cable: Length 2 m, H05VV-F3G 1.5 mm<sup>2</sup>, without connectors with wire end ferrules



## Power System Module PSM Plus

### Current carrying capacity up to 192 A per rack

Additional variant of the successful Rittal PSM concept, comprising a busbar with redundant configuration and three-phase infeed. The external dimensions remain the same, as do the familiar attachment options.

By integrating two **further** three-phase circuits the PSM now has **four** independent three-phase infeeds. Each of the feeds can be supplied with up to 3 x 16 A. In total, this produces a maximum of 192 A.

This PSM is used particularly in applications with highly-integrated blade server applications.

Thanks to the design with four independent infeeds, it is possible to configure a redundant, high-availability power supply system for IT racks, with all the familiar benefits of the PSM: Shock-hazard-protected; may be retrofitted whilst the system is operational.



### The benefits at a glance:

- 2 m busbar with four independent infeeds (**A, B, C, D** each 400 V/3~, 50/60 Hz, 3 x 16 A).
- With four integral connection cables, 5 x 2.5 mm and Wieland GST connectors.
- Directly suitable for connecting to Rittal PDM.
- Easily integrated into existing applications with standard extension cables.
- 6 slots per 2 m rail.
- Attachment with no loss of U in the rack.

### Note:

There are modules with two infeeds for use of the new PSM Plus rail. This means that redundancy can now be achieved at module level. PSM modules DK 7856.070 to DK 7856.240 may also be used. The second infeed option of the rail is not used.

### The following modules are available:

- 6-way C13, two infeeds with max. 16 A per 3 x C13
- 4-way C19, two infeeds with max. 16 A per 2 x C19
- 2-way, earthing-pin, two infeeds with max. 16 A per earthing-pin socket

Busbar	For enclosure height mm	Number of modules	Model No. DK	
	2000		6	7856.015
Assembly kit	For TS	For static installation	Without cable routing	With cable routing
		Adjustable, for freely accessible 482.6 mm (19") level	<b>7856.011</b>	<b>7856.022</b>
	For TE	For static installation	<b>7856.012</b>	<b>7856.023</b>
Plug-in modules (each half of the modules is supplied with one infeed)	EN 60 320 C13	Number of sockets	Without miniature fuse	
		6 (3 x per infeed)	<b>7856.081</b>	
	EN 60 320 C19	4 (2 x per infeed)	-	
		4 (2 x per infeed)	<b>7856.231</b>	
Earthing-pin	2 (1 x per infeed)	-		
Connection cable	Type	Length 5 m		
	Three-phase mains connection cable, EN 60 309	Three-phase connector EN 60 309 on Wieland GST socket	<b>7856.018</b>	
	Extension cable	Wieland GST socket on Wieland GST 18 connector	<b>7856.017</b>	

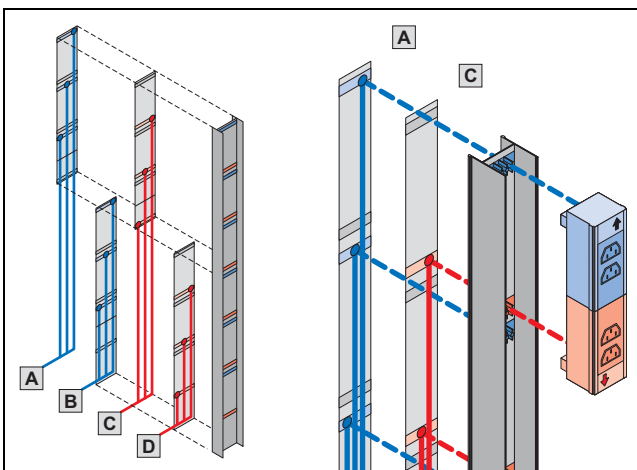





## Light 1 U

Complete ready-to-connect light for installation in the 482.6 mm (19") mounting angles. The slot attachment additionally allows it to be fastened to the 25 mm system punchings.

### Technical specifications:

8 W, 230 V, 50 Hz  
With mains switch and 2.5 m connection cable with fitted earthing-pin plug.

### Material:

Aluminium, anodised, plastic

Packs of	Model No. DK
1	7109.200



## Complete earthing kit

### for TE

To DIN EN 60 950/VDE 0805, Ø 4 mm<sup>2</sup>, I<sub>max</sub>. 40 A.  
For system-compatible earthing of all enclosure parts on the enclosure frame according to VDE. The earth conductors are pre-assembled ready for connection with connectors and cut to the right length.

Packs of	Model No. TE
1 set	7000.675

### Supply includes:

Assembly parts.

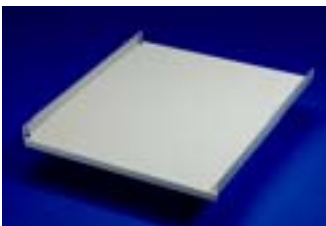

## Component shelf, static installation

### on the 482.6 mm (19") mounting angles for TE, TS, FR(i)

The component shelf is attached directly to the front and rear 482.6 mm (19") mounting angles.

### Load capacity:

30 kg surface load, static

### Material:

Sheet steel

### Colour:

RAL 7035

### Supply includes:

Assembly parts.

Width mm	Height mm	Depth mm	Distance between 19" levels mm	Model No. DK
511	22	413	495	7000.620

### Note:

Not suitable for combination with telescopic slides.

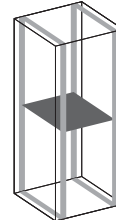

## Component shelf 1/2 U, depth-variable

### 482.6 mm (19") for TE, TS, FR(i), 19" system punchings

This space-saving component shelf is screw-fastened to the front and rear 482.6 mm (19") mounting angles. It is infinitely depth-adjustable and may be fitted independently from the enclosure.

### Load capacity:

50 kg surface load, static

### Material:

Sheet steel

### Colour:

RAL 7035/RAL 9005

Distance between levels mm	Model No. DK	
	RAL 7035	RAL 9005
400 – 600	7063.710	–
600 – 900	7063.720	7063.725

### Note:

Not suitable for combination with telescopic slides.

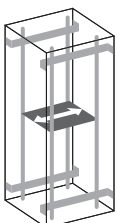

# System accessories

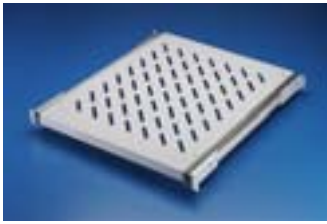

## Component shelf, complete set, pull-out for TE

Tailored to the distance between levels in enclosures as per their supplied state of 495 mm, this complete set contains a vented component shelf, telescopic slides and a mounting kit for direct attachment. The mounting kit also offers depth-variable attachment within 395 mm to 645 mm with a 25 mm pitch pattern.

**Load capacity:**  
50 kg, static

**Material:**  
Base: Sheet steel, spray-finished in RAL 7035  
Mounting kit/telescopic slides:  
Zinc-plated, passivated

**Supply includes:**  
1 component shelf, telescopic slides and mounting kit.



Base depth mm	Packs of	Model No. DK
500	1 set	7000.625

### + Accessories:

Handles for component shelf, see page 32.

## The easy route to a pull-out component shelf for the TE 7000

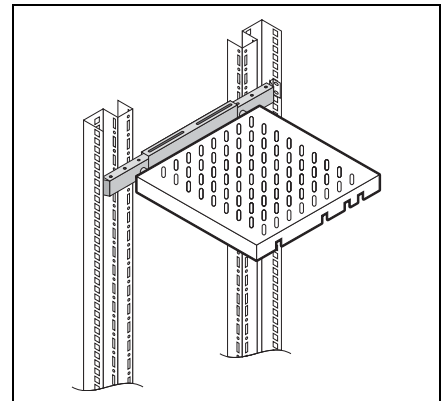
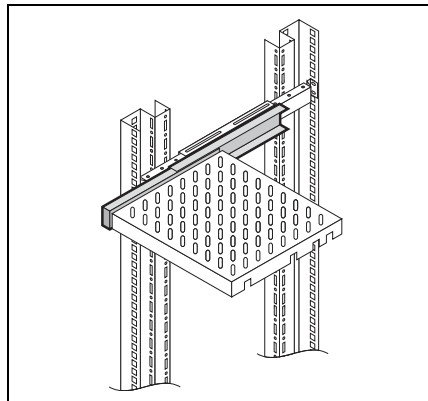
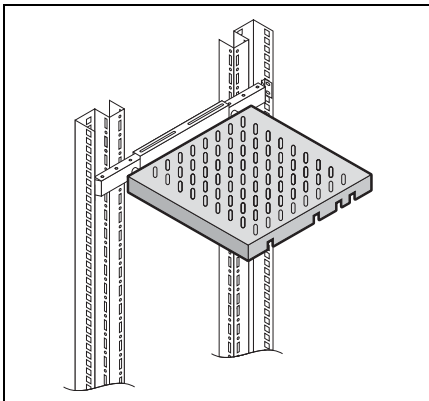
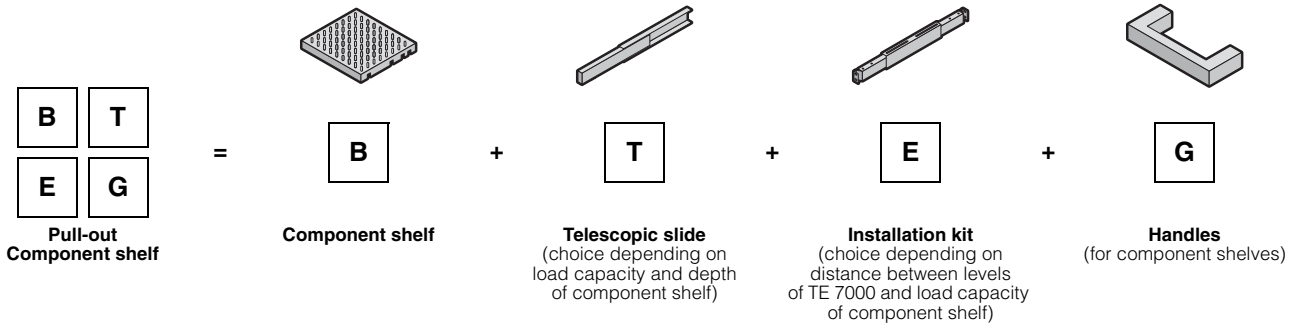

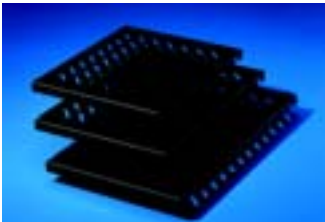

## Component shelf, 482.6 mm (19") installation

### Enclosures with two 482.6 mm (19") mounting levels for TE, TS, FR(i), 19" system punchings

Depending on their depth, the component shelves have several attachment points, so the distance between the 482.6 mm (19") mounting angles is variable within certain limits. Each component shelf secured in this way can be retrospectively upgraded to full withdrawal using telescopic slides. For this purpose, the telescopic slides are screw-fastened in place of the spacers.

**Load capacity:**  
50 kg surface load, static

**Material:**  
Sheet steel

**Colour:**  
RAL 7035/RAL 9005

**Supply includes:**  
Assembly parts.

**Note:**  
**For installation in one 482.6 mm (19") level:**  
In conjunction with 3 U side parts, mounting on only one 482.6 mm (19") level is possible. 30 kg surface load, static.

**! Also required:**

Adaptor for L-shaped mounting angles TS, see IT Catalogue, page 325.  
Installation kit, depth-variable, for installation on mounting frames and L-shaped mounting angles, see IT Catalogue, page 324.

**+ Accessories:**

Telescopic slides, see page 32.  
Cable support, hinged, see IT Catalogue, page 326.  
Side parts 3 U, see IT Catalogue, page 325.

**⇐ Possible alternative:**

Component shelf, heavy duty, for 482.6 mm (19") population, see IT Catalogue, page 321.

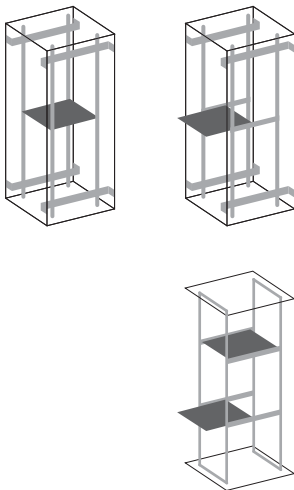
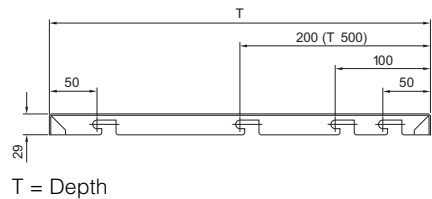

Component shelf width mm	409					Page
Component shelf depth mm	300	400	500	600	700	
Distance between levels (X)	298	348/398	348/448/498	448/548/598	548/648/698	
<b>Model No. DK RAL 7035</b>	<b>7143.035</b>	<b>7144.035</b>	<b>7145.035</b>	<b>7145.635</b>	<b>7145.735</b>	
<b>Model No. DK RAL 9005</b>	-	-	<b>7145.005</b>	<b>7145.605</b>	<b>7145.705</b>	

**+ Accessories:**

Telescopic slides for 50 kg	7051.000	7061.000	7081.000	7161.000	7161.700	32
Handles for component shelf	3636.010	3636.010	3636.010	3636.010	3636.010	32

### For TS: Note for installation in network enclosures based on TS, cranked mounting angle:

The component shelves are mounted on the sides of the 482.6 mm (19") cranked mounting angles with spacers on a U pitch pattern.

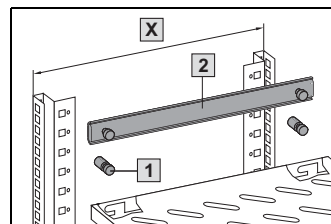

### For TS: Note for installation in network enclosures based on TS, L-shaped mounting angle:

If L-shaped mounting angles are used, adaptor DK 7827.300 is required.

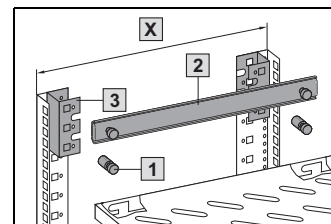

- 1** Spacers
- 2** Telescopic slides
- 3** Adaptor
- 4** Installation kit, depth-variable
- X** Distance between levels

### For TE, TS, FR(i), 482.6 mm (19") system punchings:

#### Note for installation between two mounting frames or L-shaped mounting angles:

May be mounted directly on the 482.6 mm (19") system punchings using the depth-variable installation kit.

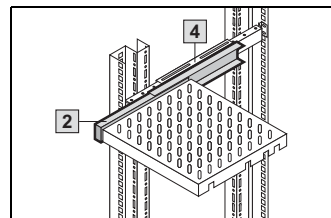

### For TS, FR(i): Note for installation between mounting angles and mounting frames:

May be mounted directly on the 482.6 mm (19") system punchings using the depth-variable installation kit.

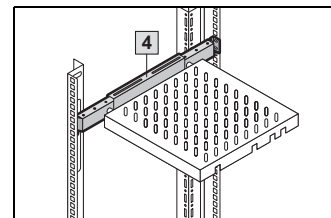



# System accessories

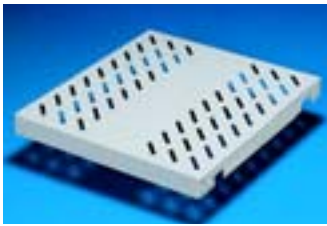

## Component shelf, heavy duty

482.6 mm (19")  
for TE, TS, FR(i)

- L-shaped mounting angles
- Mounting frame 482.6 mm (19")

**Load capacity:**  
100 kg surface load, static

**Material:**  
Sheet steel

**Colour:**  
RAL 7035/RAL 9005

**Supply includes:**  
Assembly parts.

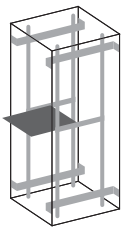
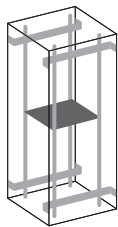
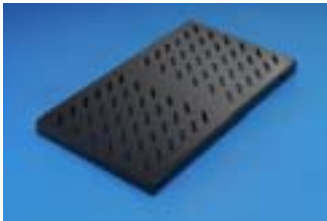

Dimensions			Model No. DK	
Width mm	Height mm	Depth mm	RAL 7035	RAL 9005
409	45	400	<b>7063.894</b>	–
409	45	500	<b>7063.895</b>	<b>7063.835<sup>1)</sup></b>
409	45	600	<b>7063.896</b>	–
409	45	700	<b>7063.897</b>	<b>7063.837</b>

<sup>1)</sup> Delivery times available on request.

### ! Also required:

Installation kit, depth-variable DK 7063.890, see IT Catalogue, page 324.

### + Accessories:

Telescopic slides (100 kg static) for 482.6 mm (19") component shelf, see page 32.



## Handles

for pull-out component shelves

The component shelves are prepared for the attachment of handles.

**Material:**  
Die-cast zinc

**Surface finish:**  
Spray-finished, silver-grey

**Supply includes:**  
Assembly parts.

Packs of	Model No. RP
2	<b>3636.010</b>

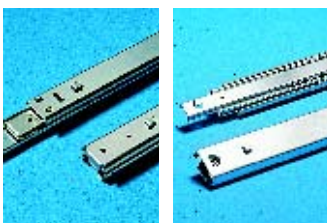

## Telescopic slides

for component shelves

Fixed component shelves are easily converted to full withdrawal. For this purpose, the existing fastening bolts or mounting rails (heavy-duty version) are exchanged for the telescopic slides.

**Technical specifications:**  
For installation and locking on a 25 mm pitch pattern in the enclosure depth.

**Load capacity:**  
50 kg/100 kg static per set

**Material:**  
Sheet steel, zinc-plated, passivated

For component shelf depth mm	Packs of	Model No. DK	
		50 kg	100 kg
300	2	<b>7051.000</b>	–
400	2	<b>7061.000</b>	<b>7064.000</b>
500	2	<b>7081.000</b>	<b>7065.000</b>
600	2	<b>7161.000</b>	<b>7066.000</b>
700	2	<b>7161.700</b>	<b>7066.700</b>

- 1** Fastening bolts
- 2** Mounting rails
- 3** Telescopic slides

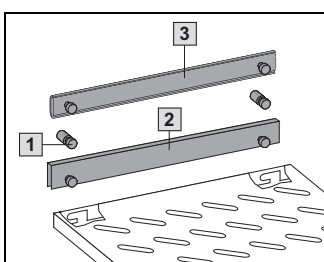

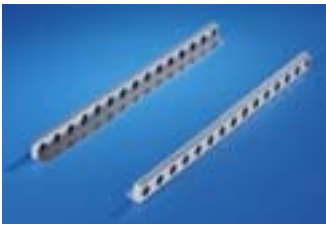

## Slide rails, heavy-duty

for TS, FR(i), TE

With L-shaped mounting angles or 482.6 mm (19") mounting frame and a clearance between levels of 740 mm.

Easily and quickly installed thanks to locating brackets for the rear level.

**Load capacity:**  
100 kg static load

**Material:**  
Sheet steel, zinc-plated, passivated

**Supply includes:**  
Assembly parts.



Distance between 19" levels mm	Contact surface		Packs of	Model No. DK
	Width mm	Depth mm		
740	50	734	2	<b>7063.740</b>

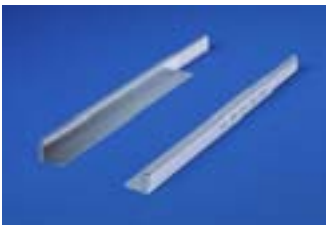

## Slide rails, depth-variable, 1 U

for server and network enclosures with two 482.6 mm (19") mounting levels and L-shaped mounting angles

The slide rail is pulled out to the required length and secured between the front and rear mounting level. Rear location lugs and front screw-fastening enable convenient one-man assembly. The mounting component to be integrated is inserted horizontally onto the slide rail and optionally secured to the mounting level via its attachment slots.

**Load capacity:**  
80 kg/150 kg, static load

**Material:**  
Sheet steel, zinc-plated, passivated

**Supply includes:**  
Assembly parts.

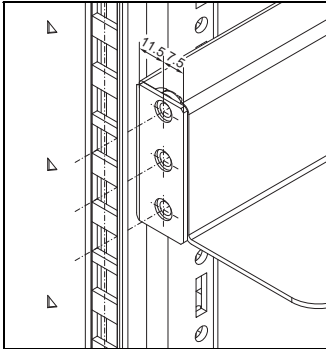

Length mm	Load capacity kg	Contact surface mm	Packs of	Model No. DK
390 – 600	80	50	2	<b>7063.882</b>
590 – 930	80	50	2	<b>7063.883</b>
590 – 930	150	25	2	<b>7063.884</b>

**Note:**

The super-slimline design of the slide rail allows it to be used in most integration cases for 482.6 mm (19") mounting components. Because it is secured to the standardised mounting level, it is manufacturer-independent.

The slide rail slightly reduces the installation space below the slide rail so that the U below it is only available for limited use.

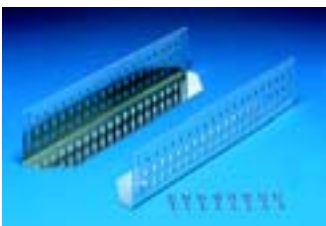

## Slide rails for FR(i), TE and 482.6 mm (19") mounting frames

For mounting between a front and a rear pair of mounting angles. The slide rails can be used to support heavy 482.6 mm (19") components.

**Load capacity:**  
80 kg, static load

**Material:**  
Sheet steel, zinc-plated, passivated

**Supply includes:**  
Assembly parts.

Distance between 19" levels mm	Contact surface		Packs of	Model No. DK
	Width mm	Depth mm		
395	85	324	2	<b>7963.310</b>
495	85	424	2	<b>7963.410</b>
595	85	524	2	<b>7963.510</b>
695	85	624	2	<b>7963.610</b>
795	85	724	2	<b>7963.710</b>

**⇔ Possible alternative:**

Slide rail, depth-variable, see page 33.



## TS punched section with mounting flange, 17 x 73 mm

Variable, with 5 rows of holes for universal skeleton structures or partial assembly. Simply locate into the TS punchings and secure.

### Installation options:

- On the vertical TS enclosure section
  - On the outer mounting level, all-round, at the same height
  - On the inner mounting level, all-round, height-offset
- In CM via rail for interior installation
  - In the depth, for outer mounting level
  - In the width, for inner mounting level
- In TE, TS, FR(i) on the 482.6 mm (19") mounting frame:
  - in the width
  - in the enclosure depth between two 482.6 mm (19") mounting frames depending on the distance selected between the 19" levels.

### Material:

Sheet steel, zinc-plated, passivated

### Supply includes:

Assembly screws.

### Note:

See also table "Quick selection" on page 47.

### German patent no. 196 47 802



### Also required:

For installation in CM, TP:  
Rail for interior installation,  
see Catalogue 32, page 992.



### Accessories:

Screws,  
see IT Catalogue, page 315.  
Cable tie for quick assembly SZ 2597.000,  
see IT Catalogue, page 353.

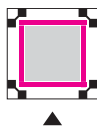
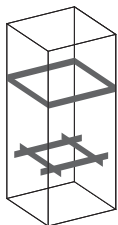
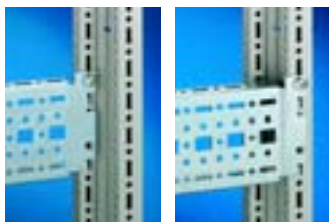

### For the outer mounting level<sup>1)</sup>

For enclosure width/depth mm	Packs of	Model No. TS
300	4	<b>8612.130</b>
400	4	<b>8612.140</b>
500	4	<b>8612.150</b>
600	4	<b>8612.160</b>
800	4	<b>8612.180</b>
1000	4	<b>8612.100</b>
1200	4	<b>8612.120</b>

### <sup>1)</sup> Note:

In conjunction with plug-in side panels, notched punched sections are required.

### For the inner mounting level

For enclosure width/depth mm	Packs of	Model No. TS
300	4	<b>8612.030</b>
400	4	<b>8612.040</b>
500	4	<b>8612.050</b>
600	4	<b>8612.060</b>
800	4	<b>8612.080</b>
900	4	<b>8612.090</b>
1000	4	<b>8612.000</b>
1200	4	<b>8612.020</b>



## TS punched section with mounting flange, 17 x 73 mm

### depth-variable for mounting frames for DK-TS, FR(i), TE

For designing a flexible interior installation, or for accommodating additional components. The punched sections with mounting flanges may be located in the enclosure depth between two mounting frames. An additional screw fastening secures the unit.

The depth variability of the rails facilitates flexible adaptation of their length to the existing attachment distance between the two 482.6 mm (19") mounting frames. An additional punched section centre piece may be slid flexibly along the rail in the depth and secured to slots. This facilitates flexible attachment at any point between the mounting frames in the enclosure depth.



Length mm	Packs of	Model No. TE
300 – 470 <sup>1) 2)</sup>	2	<b>7000.676</b>
530 – 700 <sup>1)</sup>	2	<b>7000.678</b>

<sup>1)</sup> Distance between 19" levels = length + 120 mm

<sup>2)</sup> L < 420 mm, without centre piece

### Material:

Sheet steel, zinc-plated, passivated

### Supply includes:

2 variable punched sections with mounting flanges,  
including one sliding centre part each,  
including assembly parts.

### Note:

See also table "Quick selection" on page 47.





## C rails 30/15

to EN 60 715  
for TS, ES

### Installation options:

- On the vertical TS enclosure section
  - Via snap-on nut TS 8800.808 (Fig. left)
  - Via adaptor rail for PS compatibility
- On the horizontal TS enclosure section (Fig. right)
- On the ES system punchings

### Material:

Sheet steel, zinc-plated, passivated

### Note:

See also table "Quick selection" on page 47.



For enclosure width/depth mm	Length mm	Packs of	Model No. PS
500	455	6	<b>4943.000</b>
600	555	6	<b>4944.000</b>
800	755	6	<b>4945.000</b>
1000	955	6	<b>4946.000</b>
1200	1155	6	<b>4947.000</b>



### Accessories:

Cable clamps, see page 36.  
Support bracket or spacer, see IT Catalogue, page 313.  
Quick-assembly block, see IT Catalogue, page 313.  
Snap-on nut M8, TS 8800.808, see IT Catalogue, page 310.  
Adaptor rail, see IT Catalogue, page 303.



### Possible alternative:

Rail for EMC shielding bracket and strain relief, see Cat. 32, page 1031.



## C rails

for DK-TS, CR Toptec

For direct mounting on the vertical enclosure section.

Thanks to the universally designed attachment piece, the C rails may optionally be attached to the inner or outer level of the TS 8 frame.

### Material:

Sheet steel, zinc-plated, passivated

### Supply includes:

Assembly parts.

### Note:

See also table "Quick selection" on page 47.

For enclosure width/depth mm	Length mm	Packs of	Model No. DK
400	298	4	<b>7828.040</b>
500	398	4	<b>7828.050</b>
600	498	4	<b>7828.060</b>
800	698	4	<b>7828.080</b>
900	798	4	<b>7828.090</b>
1000	898	4	<b>7828.100</b>
1200	1098	4	<b>7828.120</b>



### Accessories:

Cable clamps, see page 36.



## Cable clamp rails

for TS and 482.6 mm (19") mounting frames

The cables may be attached to the cable clamp rails with cable ties or nylon tapes. The cable clamp rails are simply located onto the frame section and may additionally be secured with a screw.

### Material:

Sheet steel, zinc-plated, passivated

### Supply includes:

Assembly parts.

### Note:

See also table "Quick selection" on page 47.



### Accessories:

Cable ties, see page 36.  
Nylon loop, see page 37.

### For the inner mounting level

For enclosures		Packs of	Model No. DK
Width mm	Depth mm		
600	600	4	<b>7828.061</b>
800	800	4	<b>7828.081</b>
900	900	4	<b>7828.091</b>
1000	1000	4	<b>7828.101</b>
1200	1200	4	<b>7828.121</b>

### For the outer mounting level

For enclosures		Packs of	Model No. DK
Width mm	Depth mm		
600	600	4	<b>7828.062</b>
800	800	4	<b>7828.082</b>
900	900	4	<b>7828.092</b>
1000	1000	4	<b>7828.102</b>
1200	1200	4	<b>7828.122</b>



## Cable clamp rails, depth-variable

### for TS and 482.6 mm (19") mounting frames

For strain relief of the routed cables. The cables may be attached to the cable clamp rails with cable ties or nylon tapes.

The cable clamp rails may be located directly on a 482.6 mm (19") mounting frame horizontally at the rear or in the enclosure depth between two mounting frames. An additional screw fastening secures the unit.

The depth variability of the rails facilitates flexible adaptation of their length to the existing attachment distance between the two 482.6 mm (19") mounting frames.

#### Material:

Sheet steel, zinc-plated, passivated

#### Supply includes:

Assembly parts.



Distance between 19" levels mm	Packs of	Model No. DK
325 – 575	4	<b>7858.160</b>
500 – 895	4	<b>7858.162</b>

#### + Accessories:

Cable ties, see page 36.  
Nylon loop, see page 37.



## Cable clamps

### for C rails

For attaching the cables to the C rails.

#### Material:

Sheet steel, zinc-plated, passivated

#### Supply includes:

Plastic insert.



For cable diameter mm	Packs of	Model No. DK
6 – 14	25	<b>7077.000</b>
12 – 18	25	<b>7078.000</b>
18 – 22	25	<b>7097.000</b>
22 – 26	25	<b>7097.220</b>
26 – 30	25	<b>7097.260</b>
30 – 34	25	<b>7097.300</b>
34 – 38	25	<b>7097.340</b>
38 – 42	25	<b>7098.000</b>
42 – 56	25	<b>7098.100</b>
56 – 64	25	<b>7099.000</b>

#### + Accessories:

C rails, see page 35 onwards.



## Cable ties

The super-fast solution for fastening cables to the enclosure profile or mounting system parts. Simply clip into the round system punchings.

Length mm	Packs of	Model No. SZ
150	100	<b>2597.000</b>



## Nylon loop

With the nylon loop, secured cables are easily released, allowing individual cables to be added or removed. Ideal for sensitive data cables (fibre-optic/Cu), as it avoids indentations on the cable sheathing.

In addition, the nylon loop may be screw-fastened to the round system punchings or attached using a quick-release fastener.

**Colour:**

Black

**Supply includes:**

Nylon loop and quick-release fastener.

Width mm	Length mm	Max. cable diameter mm	Packs of	Model No. DK
20	130	30	10	<b>7072.220</b>
20	200	50	10	<b>7072.230</b>
20	300	90	10	<b>7072.240</b>



**Also required:**

Screw SZ 2486.500 for screw-fastening to the round system punchings, see IT Catalogue, page 315.



1



2

## Cable clamp, variable

### for enclosure-independent mounting

Variable attachment from 450 to 800 mm for flexible cable clamping in two variants.

Supports attachment to punched sections with and without mounting flanges and direct screw-fastening onto mounting plates and other flat surfaces.

**Material:**

Sheet steel, zinc-plated, passivated

**Supply includes:**

Assembly parts.

1 C rail

2 T-head rail

Version	Packs of	Model No. DK
C rail	1	<b>7016.140</b>
T-head rail	1	<b>7016.150</b>



## Cable management panel, 2 U

### 482.6 mm (19")

The cable routing chamber has cut-outs from above, into which the patch cables can be inserted. The cable management panel is equipped with a flap and quick-release fasteners at the front, for optimum access to the cables. From the rear, the cables can be inserted via a cut-out with brush strips. With accommodation facility for cable clamp straps DK 7610.000 or DK 7611.000.

**Material:**

Sheet steel

**Colour:**

RAL 7035



U	Depth mm	Model No. DK
2	85	<b>7158.035</b>



**Accessories:**

Cable clamp straps, see IT Catalogue, page 356.

## Cable management panel

482.6 mm (19")

For horizontal management of the patch cables with 5 cable shunting rings, supplied loose.



**Material:**

Panel: Sheet steel  
Ring: Polyamide

**Colour:**

RAL 7035

U	Ring size mm	Model No. DK
1	70 x 44	<b>7159.035</b>



**Material:**

Panel: Sheet steel  
Ring: Polycarbonate

**Colour:**

RAL 7035

U	Ring size mm	Model No. DK
1	95 x 50	<b>7255.035</b>



**Material:**

Panel: Sheet steel  
Ring: Sheet steel, zinc-plated, passivated

**Colour:**

RAL 7035

U	Ring size mm	Model No. DK
1	105 x 43	<b>7257.035</b>
2	125 x 85	<b>7257.100</b>
1	40 x 50	<b>7257.200</b>



**Material:**

Panel: Sheet steel  
Ring: Sheet steel, zinc-plated, passivated

**Colour:**

RAL 9005

U	Ring size mm	Model No. DK
1	105 x 43	<b>7257.005</b>
2	125 x 85	<b>7257.105<sup>1)</sup></b>

<sup>1)</sup> Delivery times available on request.

**Note:**

The sizes given are external dimensions.



## Shunting ring, plastic

For flexible cable routing, in two materials and three size variants.  
Option of mounting on the 482.6 mm (19") enclosure and swing frame section of the data distributor, on the system strips of FM distribution enclosures, on all patch panels, on the Rittal Data Rack and all components on a 25 mm DIN pitch pattern.



### Polyamide version:

Infinitely adjustable fastening by means of a slot. The shunting ring DK 7218.035 may also be used on 1 U patch panels.

**Colour:**  
RAL 7035

Material	Dimensions mm	Packs of	Model No. DK
Polyamide	70 x 44	10	7218.035 <sup>1)</sup>
Polyamide	105 x 70	10	7219.035 <sup>1)</sup>
Polycarbonate	95 x 50	10	7228.035

<sup>1)</sup> German patent no. 44 13 124



### Polycarbonate version:

Variable mounting. With 45° attachment, the cable shunting ring may be attached to a 1 U panel.

**Colour:**  
RAL 7035

### Possible alternative:

Cable management panel, 482.6 mm (19"), 1 U, see page 38.

## Cable shunting ring

For flexible, system-compatible cable routing at the side of the 482.6 mm (19") mounting frame.

**Material:**  
Sheet steel, zinc-plated, passivated

**Supply includes:**  
Assembly parts.



Dimensions mm	Packs of	Model No. DK
125 x 85	10	7111.900
125 x 65	10	7111.000
85 x 43	10	7112.000

## Shunting ring

To accommodate large quantities of cables. Shunting ring for side attachment to 482.6 mm (19") extrusions and mounting frames in 800 mm wide network enclosures.

The shunting ring is attached asymmetrically, creating a clearance of approx. 110 mm in front of the 482.6 mm (19") level. This allows even large quantities of cables to be effectively managed.

**Material:**  
Round steel, zinc-plated, passivated

**Supply includes:**  
Assembly parts.



Dimensions mm	Packs of	Model No. DK
330 x 90/70	4	7220.600

# System accessories

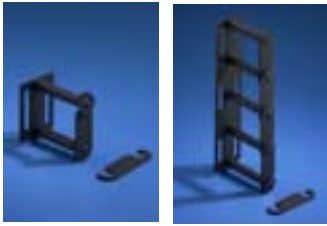

## Cable routing bars

For structured routing of entire cable bundles, the cable bars may be secured to a variety of different positions inside the enclosure.

### Material:

Support: Sheet steel

Cable routing bars, connection combs: Plastic

### Colour:

RAL 9005

### Supply includes:

Cable routing bars and connection combs.



### 482.6 mm (19") attachment

For horizontal cable routing within the distributor level.

Thanks to their open mounting holes, they can also be retrospectively slotted onto the 482.6 mm (19") system punchings of the mounting level at any time and secured with the existing mounting screws of the installed components.

Packs of	No. of connection combs	U	Model No. DK
4	2	4	<b>7111.224</b>
10	5	1	<b>7111.214</b>



### All-round attachment for universal use

For vertical and horizontal cable routing inside the enclosure or within the distributor level.

Packs of	No. of connection combs	U	Model No. DK
4	2	4	<b>7111.222</b>
10	5	1	<b>7111.212</b>



### Cranked attachment

For mounting angles and mounting frames. Horizontal, U-based cable routing to the distributor level.

Packs of	No. of connection combs	U	Model No. DK
4	2	4	<b>7111.220</b>
10	5	1	<b>7111.210</b>

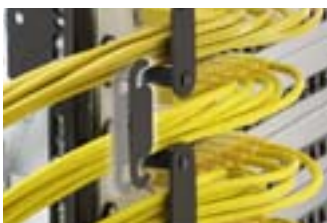

### Connection comb

For connecting individual cable routing bars into complete systems (included with the supply).



## Cable tray on the mounting frame

The mounting kit facilitates rear, side attachment of a cable tray to mounting frames inside enclosure systems TE 7000, TS and FR(i). This allows the integration of vertical cable management independently of the enclosure frame.

### Material:

Sheet steel

Packs of	Model No. DK
1 set	<b>7000.685</b>

### Surface finish:

Zinc-plated, passivated

### Supply includes:

1 cable tray 100 mm wide, 1700 mm high, including mounting kit.



## Cable duct

### for TS/TE

For laying cable in particularly high packaging densities (high density network nodes), in the field of optical fibre or copper cabling.

Large capacity. A wide range of cable routing, cable clamping, channelling and cross-cabling options creates the requirements for maximum port density in the minimum possible space. The individual U-related cable routing makes it possible to dispense with additional cable routing via patch panels within the distributor level, thereby equipping every U with connection points. Increase in port density of up to 50 %.

The removable duct cover, hinged on both sides, allows easy access at all times. The cable sections are held back by removable cross-bars to protect them against falling out. Mounting is possible both on mounting rails at the sides, and on the mounting angles and mounting frame of the 482.6 mm (19") distributor level. Two ducts may also be secured back-to-back. There is a second, smaller variant available for intensive partial installation.

### Material:

Cable duct, front trim panel:  
Sheet steel, spray-finished  
Cable routing components: Plastic

### Colour:

RAL 7035

### Supply includes:

Hinged front trim panel.



### Note:

Within the duct, additional cable ties may be attached to accommodate spare cables and for system-compatible cable deflection.

Dimensions W x D mm	No. of U	Packs of	Model No. DK
95 x 235	24	1	<b>7827.310</b>
	42	1	<b>7827.320</b>

### Note:

When using the duct in conjunction with 482.6 mm (19") mounting frames and TS 8, the inner mounting level in the vicinity of the cable duct is not available.



### Accessories:

Cable ties for spare cables:

Packs of	Model No. DK
4	<b>7827.330</b>

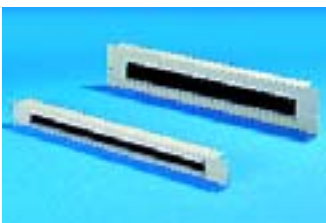

## Cable entry panel

### 482.6 mm (19")

Cut-out 390 x 40 mm (2 U) or 390 x 20 mm (1 U) with brush insert. Option of accommodating cable clamp straps DK 7610.000 or DK 7611.000.

### Material:

Sheet steel

### Colour:

RAL 7035



U	Model No. DK
1	<b>7140.535</b>
2	<b>7150.535</b>

Other versions available on request.



### Accessories:

Cable clamp straps, see IT Catalogue, page 356.



## Cable routing channel

**482.6 mm (19")**

To hold the patching cables.

**Material:**  
Sheet steel

**Colour:**  
RAL 7035

U	Depth mm	Model No. DK
1	85	<b>7149.135</b>
3	100	<b>7149.035</b>

Other versions available on request.



## Cable management panel, 2 U

To accommodate fibre-optic and copper cables. Fibres from the patch panels are placed into the tray via openings and may be distributed at the sides. Rounded openings protect the cable sheathing.

**Material:**  
Sheet steel

**Colour:**  
RAL 7035

U	Model No. DK
2	<b>7269.135</b>



## Cable management duct, horizontal

**482.6 mm (19")**

The duct facilitates concealed, simple cable routing of large quantities of cables to equipment within the 482.6 mm (19") attachment level. Large cut-outs ensure convenient, kink-free cable routing to the components top and bottom.

For simple handling, the entire front panel may be removed via quick-release fasteners. After attaching the cables, these are held in position via nylon ties, whilst the duct may be resealed.

**Material:**  
Sheet steel

**Colour:**  
RAL 7035

**Supply includes:**  
5 nylon loops.



U	Model No. DK
2	<b>7158.100</b>
3	<b>7158.150</b>



## Cable tray, 2 U

For side routing and distribution of fibre-optic and copper cables. In this way, cables inserted into the roof area may be routed at the side of the mounting angles in the upper section of the rack. Depth 85 mm.

**Material:**  
Sheet steel

**Colour:**  
RAL 7035

U	Model No. DK
2	<b>7269.235</b>



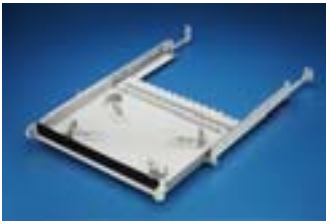

## Drawer 482.6 mm (19")

### to accommodate surplus cables

The 1 U drawer offers a convenient opportunity for storing surplus cables in an organised, compact and secure way within the 482.6 mm (19") levels.

- With brush strip at the front for cable entry
- T-head rail in the rear section for cable clamping
- Ring-shaped kink-free routing of the conductors on adjustable elements in the interior
- May be fitted between two 482.6 mm (19") levels at a distance of 435 – 750 mm
- Independent from the enclosure system
- Both on L-shaped and cranked mounting angles and mounting frames



Packs of	Distance between levels mm	Model No. DK
1	435 – 750	<b>7063.200</b>

**Material:**  
Sheet steel

**Colour:**  
RAL 7035

**Supply includes:**  
Assembly parts.

**+ Accessories:**

Nylon loop DK 7072.220/DK 7072.230, see page 37.



## Surplus cable holder

For fastening at the rear area of the enclosure, or at the side of network enclosures. The surplus cable holder can be attached to all depth stays or to punched sections and rails with a 25 mm pitch pattern – mounting dimension 150 mm. Units may also be fastened to each other.

**Material:**  
Sheet steel

**Colour:**  
RAL 7035



W x H x D mm	Model No. DK
280 x 151 x 75	<b>7220.500</b>



## Blanking panel, 482.6 mm (19")

As an extension cover or for population as required.

**Material:**  
Sheet steel



U	Installation height mm	Packs of	Model No. DK	
			RAL 7035	RAL 9005
1	44	2	<b>7151.035</b>	<b>7151.005</b>
1.5	66	2	<b>7157.035</b>	–
2	88	2	<b>7152.035</b>	<b>7152.005</b>
3	132.5	2	<b>7153.035</b>	<b>7153.005<sup>1)</sup></b>
6	266	2	<b>7156.035</b>	<b>7156.005<sup>1)</sup></b>

<sup>1)</sup> Delivery times available on request.

# System accessories



## Blanking panel, 1 U

### Toolless attachment, 482.6 mm (19")

The blanking panel is used to seal open areas within the 482.6 mm (19") mounting level. Quick toolless attachment means that it is easily integrated anywhere, and can also be removed again if necessary. Thanks to the consistent use of blanking panels, targeted air routing can be ensured in partially configured racks.

Colour	Packs of	Model No. DK
RAL 7035	10	7151.110
RAL 9005	10	7151.105

### Material:

Plastic

### Supply includes:

10 blanking panels with integral quick-fastening.

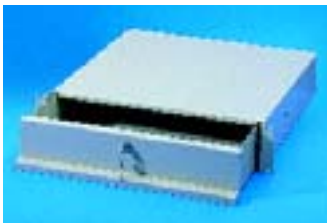

## Drawer, 2 U, 3 U

### for one 482.6 mm (19") attachment level

For front attachment to mounting angles, 482.6 mm (19"). With cover and telescopic slides to accommodate assignment lists, operating manuals and small parts. The small version of the 2 U variant is also suitable for mounting inside a swing frame.

Height	Clearance openings		Installation depth mm	Model No. DK
	Width mm	Depth mm		
2 U	411	244	250	7282.135
2 U	411	419	427	7282.035
3 U	411	419	427	7283.035

### Material:

Sheet steel

### Colour:

RAL 7035

### Supply includes:

Fully assembled, including assembly parts.

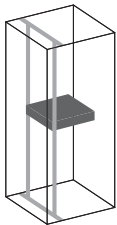

## Document drawer compartment

### for TE, TS

Closed drawer compartment to accommodate up to 2 A4 folders with spine width ≤ 50 mm, arranged one behind the other, convenient sliding extension piece on telescopic slides with latching in both end positions.

Mounting in the enclosure depth, externally at the sides on 482.6 mm (19") mounting angles and 482.6 mm (19") mounting frames of enclosures with width ≥ 800 mm.

Width mm	Height mm	Depth mm	Model No. DK
73	365	605	7283.200

### Material:

Sheet steel

### Colour:

RAL 7035

### Supply includes:

Assembly parts.

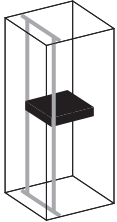

## Keyboard drawer 2 U

### for one 482.6 mm (19") attachment level

For keyboards up to 430 mm wide and 250 mm deep with the front panel folded over.

#### Material:

Sheet steel with aluminium front, spray-finished in RAL 7035

#### Supply includes:

Lockable drawer with handles, folding front, pull-out mouse pad, mouse support, practical cable entry and strain relief.

Height	Model No. DK
2 U	7281.035

Installation depth: 390 mm.



## Cage nut – front mounting, 482.6 mm (19")

The cage nut consists of an expanding nut which is simply inserted into the square attachment hole at the front and then secured with the assembly screw.

When tightening the screw, the cage expands and thus secures the required components. Clamping range from 1.2 – 4.5 mm. Multi-tooth screw head, bit size T 30.

#### Material:

Sheet steel

Dimensions mm	Size of mounting hole mm	Packs of	Model No. DK
M6 x 16	9.5 x 9.5	50	2094.400

#### Surface finish:

Zinc-plated, passivated

#### Supply includes:

50 cage nuts including assembly screws and plastic washers.



## Assembly screws

### M5 x 16 mm/M6 x 16 mm

For electronic equipment, 482.6 mm (19") installed components and blanking plates.

#### Supply includes:

Plastic washers.

Version	Packs of	Model No. EL
Phillips-head screw M5	100	2099.500
Cheese-head screw M6	100	2093.200
Phillips-head screw M6	100	2089.000



## Multi-tooth screws

### M5 x 16 mm/M6 x 16 mm

For optimum transmission of torques, an extended tool life and increased safety and reliability when tightening and loosening screw connections.

#### Supply includes:

Plastic washers.

	Bit size	Packs of	Model No. DK
M5	Multi-tooth 25	100	7094.500
M6	Multi-tooth 30	100	7094.600



## Captive nuts M5/M6

For the attachment of rack-mounted electronic equipment, 482.6 mm (19") installed equipment and blanking plates to 482.6 mm (19") mounting angles.

For use with metal thickness from 0.8 – 2.0 mm. In areas of narrow tolerance, captive nuts for metal thicknesses of 1.2 – 1.5 mm should be used. Optionally with or without contact of the installed equipment to the 482.6 mm (19") section/ enclosure.



### Captive nut M5

Version	For metal thicknesses mm	Packs of	Model No. EL
With contact	0.8 – 2.0	50	<b>2094.500</b>
Without contact	0.8 – 2.0	50	<b>2092.500</b>

### Captive nut M6

Version	For metal thicknesses mm	Packs of	Model No. EL
With contact	0.8 – 2.0	50	<b>2094.200</b>
Without contact	0.8 – 2.0	50	<b>2092.200</b>
With contact	1.2 – 1.5	50	<b>2094.300</b>
Without contact	1.2 – 1.5	50	<b>2092.300</b>



## Adhesive measurement strip, 482.6 mm (19")

Made from robust aluminium foil, guarantees easy handling and durability. With numerical labelling on an imperial pitch pattern for clear identification of the various height units. The double-sided labelling allows the counting direction to be freely selected, up to a maximum of 56 U. In this way, clear documentation of the various mounting parts is easily achieved.

### Material:

Aluminium foil

Labelling range U	Packs of	Model No. DK
1 – 56	1	<b>7950.100</b>



## Installation dimensions

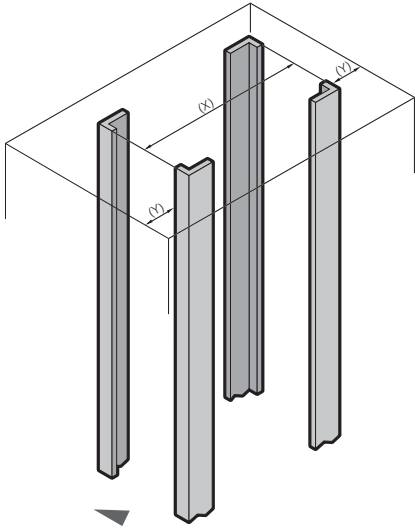

### TE

Enclosure width mm	Enclosure depth mm	Max. distance between 482.6 mm (19") levels (X) mm	Min. clearance (Y)		Mounting
			front mm	rear mm	

### TE

600	600	495	47	52	Mounting frame
600	800	695	47	52	
600	900	795	47	52	
600	1000	895	47	52	
800	600	495	47	52	
800	800	695	47	52	
800	900	795	47	52	
800	1000	895	47	52	

## Load information for 482.6 mm (19") racks



TE 7000	800 mm wide	600 mm wide	TE 7000 Server rack
19" levels	2	2	2
1	2000 N	2000 N	3500 N
2	4000 N	4000 N	7000 N

## Quick selection for TS 8 accessories for mounting on the TE 7000

corresponds to			TS punched sections with mounting flanges 17 x 73 mm for mounting of installation components	C rails, for cable clamping in the enclosure depth using cable clips	Cable clamp rails, for cable attachment using cable ties
Distance between levels (mm) TE 7000/TS 8 mounting frame 482.6 mm (19")	Enclosure width/depth TS 8 (mm) mounting, outer level	Enclosure width/depth TS 8 (mm) mounting, inner level			
445	400	-	8612.140	7828.040	7858.160 Depth-variable 445 - 695 mm
495	-	400	8612.040		
545	500	-	8612.150	7828.050	
595	-	500	8612.050		
645	600	-	8612.160	7828.060	7828.062
695	-	600	8612.060		7828.061
845	800	-	8612.180	7828.080	7828.082
895	-	800	8612.080		7828.081
945	900	-	-	7828.090	7828.092
995	-	900	8612.090		7828.091
1045	1000	-	8612.100	7828.100	7828.102
1095	-	1000	8612.000		7828.101

### TE 7000/TS 8 mounting frame 482.6 mm (19")

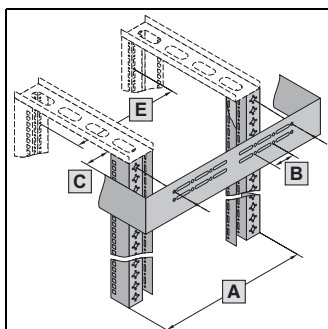

- A** Distance between the two 482.6 mm (19") levels  
Supplied state of network enclosure: 495 mm  
Supplied state of server rack: 745 mm
- B** The mounting distance in a rear mounting frame, horizontal, corresponds to the frame mounting dimensions of a 600 mm wide TS 8, outer level

### TS 8 frame

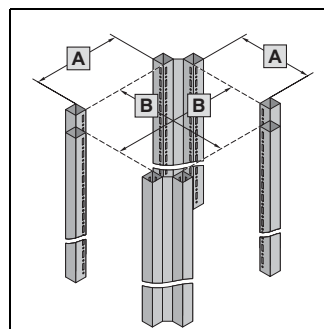

- A** Outer level
- B** Inner level

# Outstanding benefits of a complete IT infrastructure

Efficiency considerations – from acquisition, to operation, through to maintenance – indicate that Rittal offers decisive benefits and cost advantages for entire IT infrastructures with the RimatriX5:

- Reduced planning costs, thanks to modular, scalable components.
- Lower investment costs coupled with investment security, thanks to maximum flexibility.
- Lower operating costs, thanks to energy-efficient systems for cooling and power supply plus cost-effective adaptation to your requirements as they grow.
- Reduced downtime and hence lower costs, thanks to a high level of availability plus remote maintenance and administration.
- Minimal installation and expansion costs thanks to plug & play technology, and the ability to make technical modifications with the system still operational.

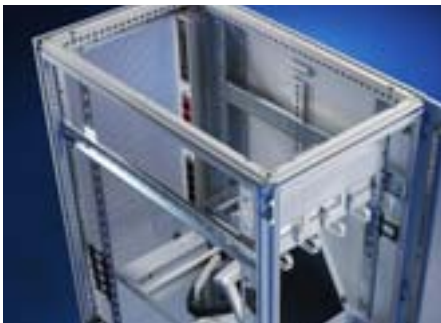
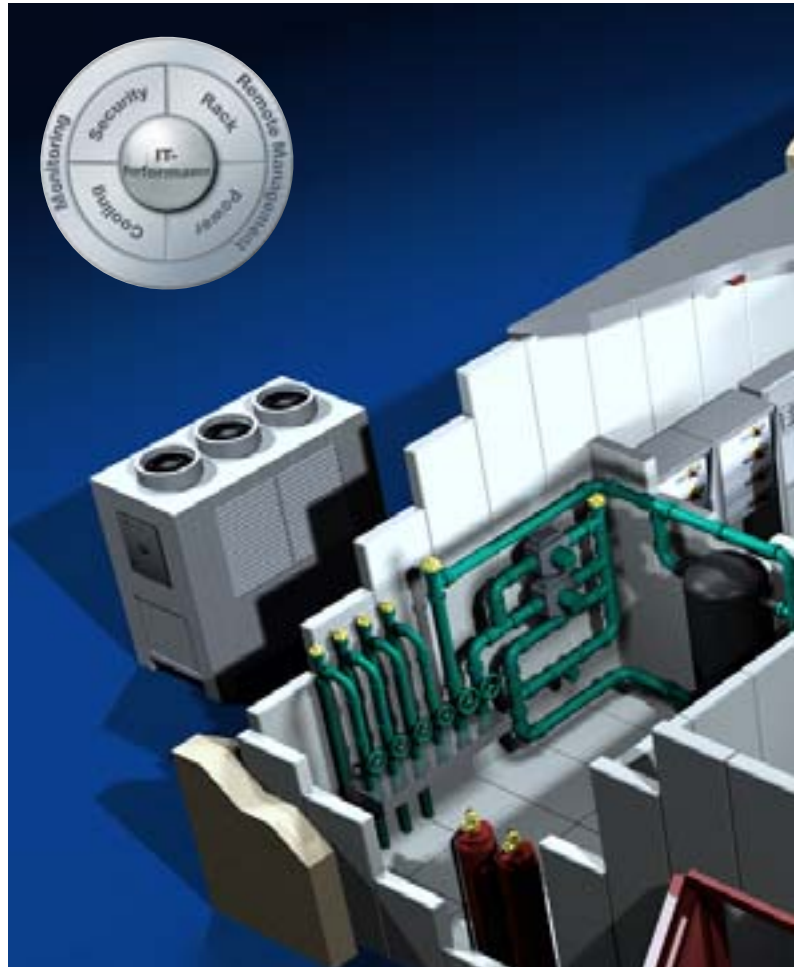

## Rack

- Perfectly designed cable management
- Load capacity up to 1000 kg within the 482.6 mm (19") installation
- Individual installation with a comprehensive range of system accessories
- Maximum useful interior volume
- Approvals and certifications
- Nanoceramic coating for maximum surface protection

IT Catalogue, from page 12

## Power

- Low-voltage switchgear (individual configuration)
- 1- and 3-phase UPS systems with 1 – 800 kW
- Pre-configured low-voltage distributor (PDR)
- Intelligent socket strips

IT Catalogue, from page 92

## Cooling

- Passive cooling with perforation of the doors or base/plinth
- Active room cooling with air circulation cooling units
- High performance cooling (LCP) up to 30 kW/rack

IT Catalogue, from page 112



### Security

Modular security management CMC

- Logging of all security-relevant parameters in and on IT racks, such as temperature or humidity
- Video monitoring
- Uncomplicated, fast and flexible with wireless sensor network

IT Catalogue, from page 152

### Monitoring & remote management

- Access control system
- SSC (Server Switch Control) for up to 2048 servers, depending on the design
- Software RiWatchIT
- Modular KVM switches (SSC)

IT Catalogue, from page 186

### Service

Individual Rittal service packages for optimum availability, sub-divided into:

- Reachability
- Response time
- Spare parts availability
- Maintenance
- Warranty extension

IT Catalogue, from page 202



## Rittal – Complete IT competence



### Rittal

#### IT infrastructure

Worldwide perfect system solutions for data centres. In RimatriX5, Rittal offers rack, power, cooling, security and monitoring from a single source.



Lampertz

### Lampertz

#### Physical IT security

One-stop suppliers for data centre structures. Modular IT security solutions, comprised of IT rooms, functional reliability, maintenance and repair.



LITCOS

### Litcos

#### Business continuity management

One of the leading companies in Europe for the analytical consultancy and holistic planning of data centre structures.

# List of model numbers

Model No.	Page	Model No.	Page	Model No.	Page	Model No.	Page	Model No.	Page
2089.000	45	7000.640	25	7072.240	37	7281.035	45	8612.120	34
2092.200	46	7000.642	25	7077.000	36	7282.035	44	8612.130	34
2092.300	46	7000.644	25	7078.000	36	7282.135	44	8612.140	34
2092.500	46	7000.650	25	7081.000	32	7283.035	44	8612.150	34
2093.200	45	7000.652	25	7094.500	45	7283.200	44	8612.160	34
2094.200	46	7000.653	22, 25	7094.600	45	7526.750	24	8612.180	34
2094.300	46	7000.654	25	7097.000	36	7526.755	24	8800.220	24
2094.400	45	7000.656	25	7097.220	36	7526.760	24	9785.040	26
2094.500	46	7000.663	22	7097.260	36	7526.770	24		
2099.500	45	7000.670	27	7097.300	36	7526.780	24		
2307.000	26	7000.671	27	7097.340	36	7526.785	24		
2435.000	25	7000.672	23	7098.000	36	7526.790	24		
2450.000	25	7000.675	29	7098.100	36	7526.795	24		
2451.000	25	7000.676	34	7099.000	36	7526.800	24		
2452.000	25	7000.678	34	7109.200	29	7526.820	24		
2454.000	25	7000.680	27	7111.000	39	7526.829	24		
2455.000	25	7000.685	40	7111.210	40	7526.834	24		
2460.000	26	7000.686	23	7111.212	40	7526.850	24		
2460.650	26	7000.687	23	7111.214	40	7526.860	24		
2461.000	26	7000.690	23	7111.220	40	7526.963	26		
2462.000	26	7000.691	23	7111.222	40	7827.310	41		
2463.000	26	7000.692	23	7111.224	40	7827.320	41		
2464.000	26	7000.693	23	7111.900	39	7827.330	41		
2465.000	26	7000.694	23	7112.000	39	7828.040	35		
2466.000	26	7000.695	23	7140.535	41	7828.050	35		
2467.000	26	7000.696	23	7143.035	31	7828.060	35		
2468.000	26	7000.698	23	7144.035	31	7828.061	35		
2469.000	26	7000.840	14	7145.005	31	7828.062	35		
2597.000	36	7000.850	14	7145.035	31	7828.080	35		
3636.010	32	7000.852	14	7145.605	31	7828.081	35		
4612.000	24	7000.882	22	7145.635	31	7828.082	35		
4943.000	35	7000.885	22	7145.705	31	7828.090	35		
4944.000	35	7000.892	22	7145.735	31	7828.091	35		
4945.000	35	7000.895	22	7149.035	42	7828.092	35		
4946.000	35	7000.930	21	7149.135	42	7828.100	35		
4947.000	35	7000.934	21	7150.535	41	7828.101	35		
7000.390	15, 16	7000.940	21	7151.005	43	7828.102	35		
7000.410	15, 16	7000.942	21	7151.035	43	7828.120	35		
7000.430	15, 16	7000.944	21	7151.105	44	7828.121	35		
7000.440	15, 16	7000.946	21	7151.110	44	7828.122	35		
7000.450	18, 19	7000.960	21	7152.005	43	7856.015	28		
7000.460	18, 19	7000.962	21	7152.035	43	7856.017	28		
7000.500	15, 17	7016.140	37	7153.005	43	7856.018	28		
7000.502	15, 17	7016.150	37	7153.035	43	7856.081	28		
7000.504	20	7051.000	32	7156.005	43	7856.101	28		
7000.505	15, 17	7061.000	32	7156.035	43	7856.231	28		
7000.508	20	7063.200	43	7157.035	43	7858.160	36		
7000.510	15, 17	7063.710	29	7158.035	37	7858.162	36		
7000.515	15, 17	7063.720	29	7158.100	42	7950.100	46		
7000.520	18, 19	7063.725	29	7158.150	42	7963.310	33		
7000.525	18, 19	7063.740	33	7159.035	38	7963.410	33		
7000.530	18, 19	7063.835	32	7161.000	32	7963.510	33		
7000.532	18, 19	7063.837	32	7161.700	32	7963.610	33		
7000.535	18, 19	7063.882	33	7218.035	39	7963.710	33		
7000.560	15, 17	7063.883	33	7219.035	39	7980.000	27		
7000.562	15, 17	7063.884	33	7220.500	43	7980.100	27		
7000.564	20	7063.894	32	7220.600	39	7980.148	27		
7000.568	20	7063.895	32	7228.035	39	8612.000	34		
7000.570	15, 17	7063.896	32	7255.035	38	8612.020	34		
7000.580	18, 19	7063.897	32	7257.005	38	8612.030	34		
7000.590	18, 19	7064.000	32	7257.035	38	8612.040	34		
7000.592	18, 19	7065.000	32	7257.100	38	8612.050	34		
7000.620	29	7066.000	32	7257.105	38	8612.060	34		
7000.625	30	7066.700	32	7257.200	38	8612.080	34		
7000.630	27	7072.220	37	7269.135	42	8612.090	34		
7000.633	25	7072.230	37	7269.235	42	8612.100	34		



## A

Active kit	
for TE	27
Adaptor	
for levelling feet	24
Adhesive measurement strip,	
482.6 mm (19")	46
Assembly screws	45

## B

Base/plinth	
for TE 7000	23
Base/plinth adaptor	
for levelling feet	24
Base/plinth trim panels	
Solid	23
Baying kit	25
Blanking panel	43
Busbar	
Plug-in modules	28

## C

C rails	35
Cable clamp rails	
Depth-variable	36
for TS and 482.6 mm (19")	
mounting frames	35
Cable clamp, variable	37
Cable clamps	
for C rails	36
Cable duct for TS/TE	41
Cable gland panel	
482.6 mm (19")	41
Cable management duct	
horizontal, 482.6 mm (19")	42
Cable management panel	37, 38
Cable routing bars	40
Cable routing channel	
482.6 mm (19")	42
Cable shunting ring	39
Cable ties	36, 41
Cable tray	
on the mounting frame	40
Cable tray, 2 U	42
Cage nut – front mounting,	
482.6 mm (19")	45
Captive nuts M5/M6	46
Complete earthing kit	29
Component shelf	
for TE	30
Heavy duty	32
Component shelf 1/2 U, depth-variable	29
Component shelf, static installation	29

## D

Distributor frame TE 7000 open	21
Document drawer compartment	
for TE, TS	44
Drawers	
482.6 mm (19")	44
482.6 mm (19"),	
to accommodate surplus cables	43

## E

Earthing kit, complete	
for TE	29
Enclosure light	29
Ergoform-S lock system	25

## F

Fan expansion kit	27
Fan unit, active	
for TE	27
Feet	24

## H

Handles	
Ergoform-S handle	25
for component shelves	32
High density cable duct	41

## K

Keyboard drawer	45
-----------------	----

## L

Levelling feet	24
Lights	29
Lock and push-button inserts	26
Lock inserts	26

## M

Module plates	24
Mounting angles	
C rails	35
Mounting kit	
for cable trays	40
Multi-tooth screws	45

## N

Network enclosures	
Based on Rittal TE 7000	14, 19
Based on Rittal TE 7000 open	21
Based on Rittal TE 7000,	
metric attachment level	20
Nylon loop	37

## P

Plug-in PSM modules for busbar	28
Punched section with mounting flange	
17 x 73 mm, TS	34
Push-button and lock inserts	26

## S

Screws	45
Semi-cylinder	26
Server integration	47
Server racks	
Based on Rittal TE 7000	22
Shunting ring	39
Side panels	
for TE	25
Slide rails	
for FR(i), TE and 482.6 mm (19")	
mounting frames	33
Heavy-duty for TS, FR(i), TE	33
Slide rails, depth-variable	
1 U	33
Socket strip TE	27
Spacers	
for module plates TE	26
Support strips	
TS	34
Surplus cable holder	43

## T

TE 7000	
Metric attachment level	20
Network enclosures	14, 19
Open, distributor frame	21
Server racks	22
Telescopic slides	
for component shelves	32
Transport castors	
for TE	23
TS	
Punched section	
with mounting flange	34

# All in all – solutions from Rittal



**Industrial Enclosures**



**Power Distribution**



**Electronic Packaging**



**System Climate Control**



**IT Solutions**

Network enclosures · Server racks · KVM technology  
Telco racks · Office solutions · Distributor racks  
Wall-mounted enclosures · RimatriX5 · Power management  
concepts · IT cooling · Monitoring · Security · Services · Kiosks



**Communication Systems**

Rittal has one of the largest ranges of enclosures available for immediate delivery. However, Rittal also supplies integrated solutions – up to Level 4. This comprises mechanical installation, power supply, electronic components, climate control and central monitoring. For all of your requirements.

Fully assembled and functional. Wherever in the world you develop and implement solutions for yourself and your customers, we are close at hand. The global alliance between production, distribution and service guarantees closeness to the customer. Worldwide!

02/09 · E543

Rittal GmbH & Co. KG · Postfach 1662 · D-35726 Herborn  
Telephone: +49(0)2772 505-0 · Telefax: +49(0)2772 505-2319 · eMail: info@rittal.de · www.rittal.com



*Switch to perfection* **RITTAL**