

Lay-In NEMA Type 1 Hinged-Cover Wireway

Lay-In Hinged-Cover Wireway, NEMA Type 1



Application

This wireway provides convenient cable installation and maintenance with its top hinged cover and an opening on one side so wires and cables can be laid in along the entire run without pulling. A variety of lengths and fittings provide increased design flexibility.

Features

- Open top assembly
- Removable hinged cover latches with captive screws
- 12.00 x 12.00-in. models available in hinged or non-hinged styles
- Available with or without knockouts on wireway sides
- Covers include captivated plated screw fasteners

Specifications

- 16 gauge or 14 gauge steel covers and bodies

Finish

ANSI 61 gray polyester powder paint finish inside and out over pretreated surfaces.

Accessories

See *Accessories* chapter.
Touch-Up Paint (ATPPY61)

Industry Standards

UL 870 Listed; File No. E27524
cUL Listed per CSA C22.2 No. 26; File No. E27524

NEMA/EEMAC Type 1
IEC 60529, IP30

This drawing illustrates how most of the Hoffman NEMA Type 1 lay-in wireway sections and fittings could be used in an actual wireway run. The covers have been omitted to present the lay-in feature more clearly. Many different sections and fittings can be combined in any configuration desired.

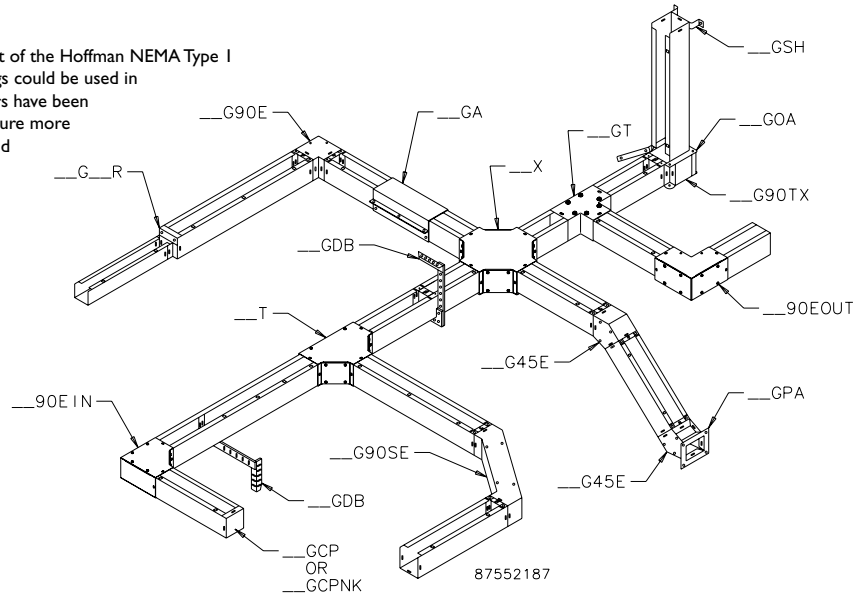

Lay-In NEMA Type 1 Hinged-Cover Wireway

Standard Product Selection Matrix

Description	2.50 x 2.50 in.	4.00 x 4.00 in.	6.00 x 6.00 in.	8.00 x 8.00 in.	10.00 x 10.00 in.	Not Hinged	Hinged
	(64 x 64 mm) 16 Gauge	(102 x 102 mm) 16 Gauge	(152 x 152 mm) 16 Gauge	(203 x 203 mm) 14 Gauge	(254 x 254 mm) 14 Gauge	12.00 x 12.00 in. (305 x 305 mm) 14 Gauge	12.00 x 12.00 in. (305 x 305 mm) 14 Gauge
12.00-in. (305-mm) Straight Section with knockouts	F22G12WK	F44G12WK	F66G12WK	—	F66G12WK	—	—
12.00-in. (305-mm) Straight Section without knockouts	F22G12	F44G12	F66G12	F66G12	F101G12	F121G12	F121G12H
18.00-in. (455-mm) Straight Section without knockouts	—	F44G18	F66G18	F88G18	—	—	—
24.00-in. (610-mm) Straight Section with knockouts	F22G24WK	F44G24WK	F66G24WK	—	—	—	—
24.00-in. (610-mm) Straight Section without knockouts	F22G24	F44G24	F66G24	F88G24	F101G24	F121G24	F121G24H
36.00-in. (914-mm) Straight Section with knockouts	F22G36WK	F44G36WK	F66G36WK	—	—	—	—
36.00-in. (914-mm) Straight Section without knockouts	F22G36	F44G36	F66G36	F88G36	F101G36	F121G36	F121G36H
48.00-in. (1219-mm) Straight Section with knockouts	F22G48WK	F44G48WK	F66G48WK	—	—	—	—
48.00-in. (1219-mm) Straight Section without knockouts	F22G48	F44G48	F66G48	F88G48	F101G48	F121G48	F121G48H
60.00-in. (1524-mm) Straight Section with knockouts	F22G60WK	F44G60WK	F66G60WK	—	—	—	—
60.00-in. (1524-mm) Straight Section without knockouts	F22G60	F44G60	F66G60	F88G60	F101G60	F121G60	F121G60H
72.00-in. (1829-mm) Straight Section with knockouts	—	F44G72WK	F66G72WK	—	—	—	—
72.00-in. (1829-mm) Straight Section without knockouts	—	F44G72	F66G72	F88G72	F101G72	F121G72	F121G72H
96.00-in. (2438-mm) Straight Section without knockouts	—	F44G96	F66G96	F88G96	F101G96	F121G96	—
120.00-in. (3048-mm) Straight Section with knockouts	F22G120WK	F44G120WK	F66G120WK	—	—	—	—
120.00-in. (3048-mm) Straight Section without knockouts	F22G120	F44G120	F66G120	F66G120	F101G120	F121G120	F121G120H
90° Flush Tee	F22GT	F44GT	F66GT	F88GT	F101GT	F121GT	F121GT
Sweep Tee	F22T	F44T	F66T	F88T	F101T	F121T	F121T
Cross Fitting	F22X	F44X	F66X	F88X	F101X	F121X	F121X
90° Sweep Elbow	F22G90SE	F44G90SE	F66G90SE	F88G90SE	F101G90SE	F121G90SE	F121G90SE
90° Elbow-Tee-Cross	F22G90TX	F44G90TX	F66G90TX	F88G90TX	F101G90TX	F121G90TX	F121G90TX
90° Elbow	F22G90E	F44G90E	F66G90E	F88G90E	F101G90E	F121G90E	F121G90E
90° Elbow Outside Opening	F2290EOUT	F4490EOUT	F6690EOUT	F8890EOUT	F10190EOUT	F12190EOUT	F12190EOUT
90° Elbow Inside Opening	F2290EIN	F4490EIN	F6690EIN	F8890EIN	F10190EIN	F12190EIN	F12190EIN
45° Elbow	F22G45E	F44G45E	F66G45E	F88G45E	F101G45E	F121G45E	F121G45E
Telescope Fitting ^a	F22GA	F44GA	F66GA	F88GA	F101GA	F121GA	F121GA
Open Adapter	F22GOA	F44GOA	F66GOA	F88GOA	F101GOA	F121GOA	F121GOA
Panel Adapter	F22GPA	F44GPA	F66GPA	F88GPA	F101GPA	F121GPA	F121GPA
Closure Plate without knockouts	F22GCPNK	F44GCPNK	F66GCPNK	F88GCPNK	F101GCPNK	F121GCPNK	F121GCPNK
Closure Plate with knockouts	F22GCP	F44GCP	F66GCP	F88GCP	F101GCP	F121GCP	F121GCP
Reducer	—	F44G22R	F66G44R	F88G66R	F101G88R	F121G101R	F121G101R
Drop and Bracket Hanger	F22GDB	F44GDB	F66GDB	F88GDB	F101GDB	F121GDB	F121GDB
Support Hanger	F22GSH	F44GSH	F66GSH	F88GSH	F101GSH	F121GSH	F121GSH
Universal U-Connector	F22GUC	F44GUC	F66GUC	F88GUC	F101GUC	F121GUC	F121GUC
Barrier Kit, bolt-on	—	F44BK60	F66BK60	F88BK60	—	—	—

^aNot UL/cUL listed.

Straight Section

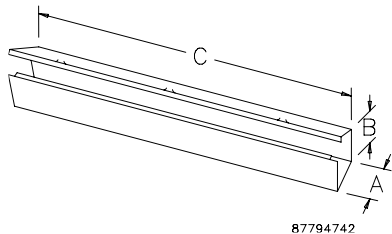

87794742

Available in lengths from 12.00 in. (305 mm), with or without knockouts.

Bulletin: F40, F40PF

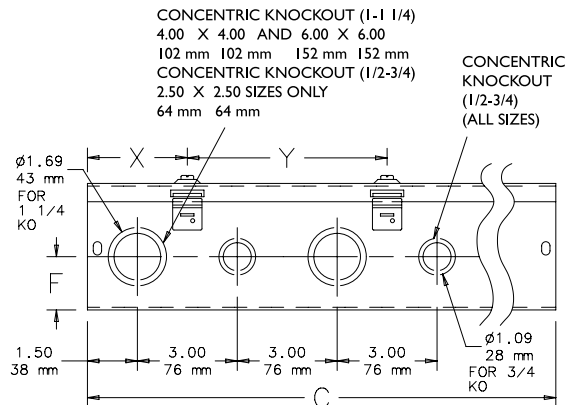

87794694

Patented hidden hinge permits usual plated steel screw cover arrangement to be converted to hinge cover system on all sizes except 12.00 in x 12.00 in. (305mm x 305mm).

Lay-In NEMA Type 1 Hinged-Cover Wireway

Straight Sections

Catalog Number	AxBxC in.	AxBxC mm	Number of Knockouts,		F (in.)	F (mm)	X (in.)	X (mm)	Y (in.)	Y (mm)
			.50 in.-.75 in.	1.00 in.-1.25 in.						
F22G12WK	2.50 x 2.50 x 12.00	64 x 64 x 305	8	—	1.06	27	3.00	76	6.00	152
F22G12	2.50 x 2.50 x 12.00	64 x 64 x 305	—	—	—	—	—	—	—	—
F22G24WK	2.50 x 2.50 x 24.00	64 x 64 x 610	16	—	1.06	27	6.00	152	12.00	305
F22G24	2.50 x 2.50 x 24.00	64 x 64 x 610	—	—	—	—	—	—	—	—
F22G36WK	2.50 x 2.50 x 36.00	64 x 64 x 914	24	—	1.06	27	6.00	152	12.00	305
F22G36	2.50 x 2.50 x 36.00	64 x 64 x 914	—	—	—	—	—	—	—	—
F22G48WK	2.50 x 2.50 x 48.00	64 x 64 x 1219	32	—	1.06	27	6.00	152	12.00	305
F22G48	2.50 x 2.50 x 48.00	64 x 64 x 1219	—	—	—	—	—	—	—	—
F22G60WK	2.50 x 2.50 x 60.00	64 x 64 x 1524	40	—	1.06	27	6.00	152	12.00	305
F22G60	2.50 x 2.50 x 60.00	64 x 64 x 1524	—	—	—	—	—	—	—	—
F22G120WK	2.50 x 2.50 x 120.00	64 x 64 x 3048	80	—	1.06	27	6.00	152	12.00	305
F22G120	2.50 x 2.50 x 120.00	64 x 64 x 3048	—	—	—	—	—	—	—	—
F44G12WK	4.00 x 4.00 x 12.00	102 x 102 x 305	4	4	1.62	41	3.00	76	6.00	152
F44G12	4.00 x 4.00 x 12.00	102 x 102 x 305	—	—	—	—	—	—	—	—
F44G18	4.00 x 4.00 x 18.00	102 x 102 x 455	—	—	—	—	—	—	—	—
F44G24WK	4.00 x 4.00 x 24.00	102 x 102 x 610	8	8	1.62	41	6.00	152	12.00	305
F44G24	4.00 x 4.00 x 24.00	102 x 102 x 610	—	—	—	—	—	—	—	—
F44G36WK	4.00 x 4.00 x 36.00	102 x 102 x 914	12	12	1.62	41	6.00	152	12.00	305
F44G36	4.00 x 4.00 x 36.00	102 x 102 x 914	—	—	—	—	—	—	—	—
F44G48WK	4.00 x 4.00 x 48.00	102 x 102 x 1219	16	16	1.62	41	6.00	152	12.00	305
F44G48	4.00 x 4.00 x 48.00	102 x 102 x 1219	—	—	—	—	—	—	—	—
F44G60WK	4.00 x 4.00 x 60.00	102 x 102 x 1524	20	20	1.62	41	6.00	152	12.00	305
F44G60	4.00 x 4.00 x 60.00	102 x 102 x 1524	—	—	—	—	—	—	—	—
F44G72WK	4.00 x 4.00 x 72.00	102 x 102 x 1829	24	24	1.62	41	6.00	152	12.00	305
F44G72	4.00 x 4.00 x 72.00	102 x 102 x 1829	—	—	—	—	—	—	—	—
F44G96	4.00 x 4.00 x 96.00	102 x 102 x	—	—	—	—	—	—	—	—
F44G120WK	4.00 x 4.00 x 120.00	102 x 102 x 3048	40	40	1.62	41	6.00	152	12.00	305
F44G120	4.00 x 4.00 x 120.00	102 x 102 x 3048	—	—	—	—	—	—	—	—
F66G12WK	6.00 x 6.00 x 12.00	152 x 152 x 305	4	4	1.62	41	3.00	76	6.00	152
F66G12	6.00 x 6.00 x 12.00	152 x 152 x 305	—	—	—	—	—	—	—	—
F66G18	6.00 x 6.00 x 18.00	152 x 152 x 455	—	—	—	—	—	—	—	—
F66G24WK	6.00 x 6.00 x 24.00	152 x 152 x 610	8	8	1.62	41	6.00	152	12.00	305
F66G24	6.00 x 6.00 x 24.00	152 x 152 x 610	—	—	—	—	—	—	—	—
F66G36WK	6.00 x 6.00 x 36.00	152 x 152 x 914	12	12	1.62	41	6.00	152	12.00	305
F66G36	6.00 x 6.00 x 36.00	152 x 152 x 914	—	—	—	—	—	—	—	—
F66G48WK	6.00 x 6.00 x 48.00	152 x 152 x 1219	16	16	1.62	41	6.00	152	12.00	305
F66G48	6.00 x 6.00 x 48.00	152 x 152 x 1219	—	—	—	—	—	—	—	—
F66G60WK	6.00 x 6.00 x 60.00	152 x 152 x 1524	20	20	1.62	41	6.00	152	12.00	305
F66G60	6.00 x 6.00 x 60.00	152 x 152 x 1524	—	—	—	—	—	—	—	—
F66G72WK	6.00 x 6.00 x 72.00	152 x 152 x 1829	24	24	1.62	41	6.00	152	12.00	305
F66G72	6.00 x 6.00 x 72.00	152 x 152 x 1829	—	—	—	—	—	—	—	—
F66G96	6.00 x 6.00 x 96.00	152 x 152 x 2438	—	—	—	—	—	—	—	—
F66G120WK	6.00 x 6.00 x 120.00	152 x 152 x 3048	40	40	1.62	41	6.00	152	12.00	305
F66G120	6.00 x 6.00 x 120.00	152 x 152 x 3048	—	—	—	—	—	—	—	—
F88G12	8.00 x 8.00 x 12.00	203 x 203 x 305	—	—	—	—	—	—	—	—
F88G18	8.00 x 8.00 x 18.00	203 x 203 x 455	—	—	—	—	—	—	—	—
F88G24	8.00 x 8.00 x 24.00	203 x 203 x 610	—	—	—	—	—	—	—	—
F88G36	8.00 x 8.00 x 36.00	203 x 203 x 914	—	—	—	—	—	—	—	—
F88G48	8.00 x 8.00 x 48.00	203 x 203 x 1219	—	—	—	—	—	—	—	—
F88G60	8.00 x 8.00 x 60.00	203 x 203 x 1524	—	—	—	—	—	—	—	—
F88G72	8.00 x 8.00 x 72.00	203 x 203 x 1829	—	—	—	—	—	—	—	—
F88G96	8.00 x 8.00 x 96.00	203 x 203 x 2438	—	—	—	—	—	—	—	—
F88G120	8.00 x 8.00 x 120.00	203 x 203 x 3048	—	—	—	—	—	—	—	—
F1010G12	10.00 x 10.00 x 12.00	254 x 254 x 305	—	—	—	—	—	—	—	—
F1010G24	10.00 x 10.00 x 24.00	254 x 254 x 610	—	—	—	—	—	—	—	—
F1010G36	10.00 x 10.00 x 36.00	254 x 254 x 914	—	—	—	—	—	—	—	—
F1010G48	10.00 x 10.00 x 48.00	254 x 254 x 1219	—	—	—	—	—	—	—	—
F1010G60	10.00 x 10.00 x 60.00	254 x 254 x 1524	—	—	—	—	—	—	—	—
F1010G72	10.00 x 10.00 x 72.00	254 x 254 x 1829	—	—	—	—	—	—	—	—
F1010G96	10.00 x 10.00 x 96.00	254 x 254 x 2438	—	—	—	—	—	—	—	—
F1010G120	10.00 x 10.00 x 120.00	254 x 254 x 3048	—	—	—	—	—	—	—	—
F1212G12	12.00 x 12.00 x 12.00	305 x 305 x 305	—	—	—	—	—	—	—	—
F1212G12H	12.00 x 12.00 x 12.00	305 x 305 x 305	—	—	—	—	—	—	—	—
F1212G24	12.00 x 12.00 x 24.00	305 x 305 x 610	—	—	—	—	—	—	—	—
F1212G24H	12.00 x 12.00 x 24.00	305 x 305 x 610	—	—	—	—	—	—	—	—
F1212G36	12.00 x 12.00 x 36.00	305 x 305 x 914	—	—	—	—	—	—	—	—
F1212G36H	12.00 x 12.00 x 36.00	305 x 305 x 914	—	—	—	—	—	—	—	—
F1212G48	12.00 x 12.00 x 48.00	305 x 305 x 1219	—	—	—	—	—	—	—	—
F1212G48H	12.00 x 12.00 x 48.00	305 x 305 x 1219	—	—	—	—	—	—	—	—
F1212G60	12.00 x 12.00 x 60.00	305 x 305 x 1524	—	—	—	—	—	—	—	—
F1212G60H	12.00 x 12.00 x 60.00	305 x 305 x 1524	—	—	—	—	—	—	—	—
F1212G72	12.00 x 12.00 x 72.00	305 x 305 x 1829	—	—	—	—	—	—	—	—
F1212G72H	12.00 x 12.00 x 72.00	305 x 305 x 1829	—	—	—	—	—	—	—	—
F1212G96	12.00 x 12.00 x 96.00	305 x 305 x 2438	—	—	—	—	—	—	—	—
F1212G120	12.00 x 12.00 x 120.00	305 x 305 x 3048	—	—	—	—	—	—	—	—
F1212G120H	12.00 x 12.00 x 120.00	305 x 305 x 3048	—	—	—	—	—	—	—	—

F1212GXX catalog numbers without "H" are not hinged. F1212GXXH catalog numbers are hinged.

Lay-In NEMA Type 1 Hinged-Cover Wireway

90-Degree Flush Tee

For flush mounting against a vertical or horizontal surface.

Bulletin: F40PF

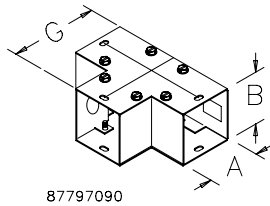

87797090

Catalog Number	AxB in./mm	G in./mm
F22GT	2.50 x 2.50 64 x 64	4.50 114
F33GT	3.00 x 3.00 76 x 76	5.00 127
F44GT	4.00 x 4.00 102 x 102	6.00 152
F66GT	6.00 x 6.00 152 x 152	8.00 203
F88GT	8.00 x 8.00 203 x 203	10.00 254
F1010GT	10.00 x 10.00 254 x 254	12.00 305
F1212GT	12.00 x 12.00 305 x 305	14.00 356

Sweep Tee

For large radius turns. Mounts against vertical or horizontal surfaces. Top and inside covers removable.

Bulletin: F40PF

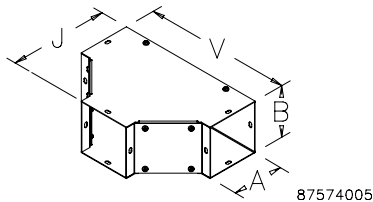

87574005

Catalog Number	AxB in./mm	J in./mm	V in./mm
F22T	2.50 x 2.50 64 x 64	6.50 165	10.35 263
F44T	4.00 x 4.00 102 x 102	8.00 203	11.85 301
F66T	6.00 x 6.00 152 x 152	10.00 254	13.85 352
F88T	8.00 x 8.00 203 x 203	12.00 305	15.84 402
F1010T	10.00 x 10.00 254 x 254	14.00 356	17.84 453
F1212T	12.00 x 12.00 305 x 305	16.00 406	19.84 504

Cross Fitting

For routing cables in four directions. Top, bottom and side covers removable.

Bulletin: F40PF

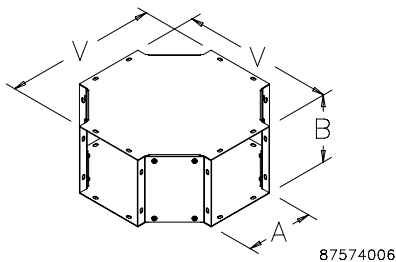

87574006

Catalog Number	AxB in./mm	V in./mm
F22X	2.50 x 2.50 64 x 64	10.35 263
F44X	4.00 x 4.00 102 x 102	11.85 301
F66X	6.00 x 6.00 152 x 152	13.85 352
F88X	8.00 x 8.00 203 x 203	15.84 402
F1010X	10.00 x 10.00 254 x 254	17.84 453
F1212X	12.00 x 12.00 305 x 305	19.84 504

90-Degree Sweep Elbow

For large radius turns.

Bulletin: F40PF

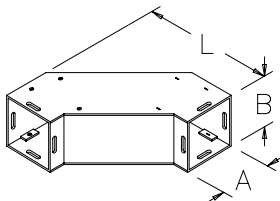

87797091

Catalog Number	AxB in./mm	L in./mm
F22G90SE	2.50 x 2.50 64 x 64	7.91 201
F44G90SE	4.00 x 4.00 102 x 102	9.41 239
F66G90SE	6.00 x 6.00 152 x 152	11.34 288
F88G90SE	8.00 x 8.00 203 x 203	13.44 341
F1010G90SE	10.00 x 10.00 254 x 254	15.62 395
F1212G90SE	12.00 x 12.00 305 x 305	17.44 443

Lay-In NEMA Type 1 Hinged-Cover Wireway

90-Degree Elbow-Tee-Cross

Forms left or right 90-degree turns. Can be used as a tee or cross. Use with open adapter for cable entrance in top and bottom. Includes two closure plates.

Bulletin: F40PF

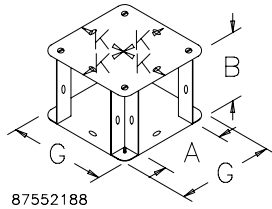

Catalog Number	AxB in./mm	G in./mm	K in./mm
F22G90TX	2.50 x 2.50 64 x 64	4.50 114	2.25 57
F33G90TX	3.00 x 3.00 76 x 76	5.00 127	2.50 64
F44G90TX	4.00 x 4.00 102 x 102	6.00 152	3.00 76
F66G90TX	6.00 x 6.00 152 x 152	8.00 203	4.00 102
F88G90TX	8.00 x 8.00 203 x 203	10.00 254	5.00 127
F1010G90TX	10.00 x 10.00 254 x 254	12.00 305	6.00 152
F1212G90TX	12.00 x 12.00 305 x 305	14.00 356	7.00 178

90-Degree Elbow

Any side can be removed, retaining lay-in feature regardless of how the elbow is oriented. Sides are held together with screws.

Bulletin: F40PF

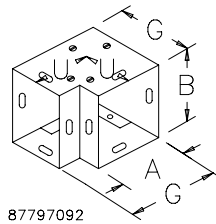

Catalog Number	AxB in./mm	G in./mm
F22G90E	2.50 x 2.50 64 x 64	4.50 114
F33G90E	3.00 x 3.00 76 x 76	5.00 127
F44G90E	4.00 x 4.00 102 x 102	6.00 152
F66G90E	6.00 x 6.00 152 x 152	8.00 203
F88G90E	8.00 x 8.00 203 x 203	10.00 254
F1010G90E	10.00 x 10.00 254 x 254	12.00 305
F1212G90E	12.00 x 12.00 305 x 305	14.00 356

90-Degree Elbow—Outside Opening

For continuous run with 90-degree turns. Top, bottom and outside covers removable.

Bulletin: F40PF

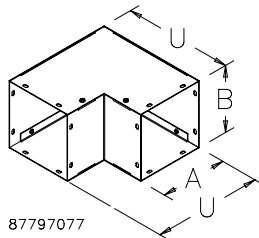

Catalog Number	AxB in./mm	U in./mm
F2290EOUT	2.50 x 2.50 64 x 64	6.50 165
F4490EOUT	4.00 x 4.00 102 x 102	8.00 203
F6690EOUT	6.00 x 6.00 152 x 152	10.00 254
F8890EOUT	8.00 x 8.00 203 x 203	12.00 305
F101090EOUT	10.00 x 10.00 254 x 254	14.00 356
F121290EOUT	12.00 x 12.00 305 x 305	16.00 406

90-Degree Elbow—Inside Opening

For continuous run with 90-degree turns. Top and inside covers removable.

Bulletin: F40PF

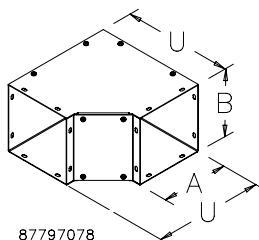

Catalog Number	AxB in./mm	U in./mm
F2290EIN	2.50 x 2.50 64 x 64	6.50 165
F4490EIN	4.00 x 4.00 102 x 102	8.00 203
F6690EIN	6.00 x 6.00 152 x 152	10.00 254
F8890EIN	8.00 x 8.00 203 x 203	12.00 305
F101090EIN	10.00 x 10.00 254 x 254	14.00 356
F121290EIN	12.00 x 12.00 305 x 305	16.00 406

Lay-In NEMA Type 1 Hinged-Cover Wireway

45-Degree Elbow

For continuous run with 45-degree turns. Top and inside covers removable.

Bulletin: F40PF

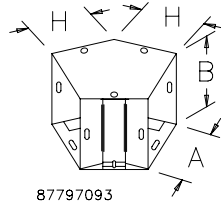

Catalog Number	AxB in./mm	H in./mm
F22G45E	2.50 x 2.50 64 x 64	2.75 70
F33G45E	3.00 x 3.00 76 x 76	2.99 76
F44G45E	4.00 x 4.00 102 x 102	3.38 86
F66G45E	6.00 x 6.00 152 x 152	4.25 108
F88G45E	8.00 x 8.00 203 x 203	5.06 129
F1010G45E	10.00 x 10.00 254 x 254	6.00 152
F1212G45E	12.00 x 12.00 305 x 305	6.75 171

Telescope Fitting

Length easily adjusts to approximately 12.00 in. (305 mm). No cutting or welding required.

Bulletin: F40PF



Catalog Number	AxB in./mm
F22GA	2.50 x 2.50 64 x 64
F44GA	4.00 x 4.00 102 x 102
F66GA	6.00 x 6.00 152 x 152
F88GA	8.00 x 8.00 203 x 203
F1010GA	10.00 x 10.00 254 x 254
F1212GA	12.00 x 12.00 305 x 305

These items not UL/cUL listed.

Open Adapter

Used with the 90-Degree Elbow-Tee-Cross fitting to permit a run directly up or down.

Bulletin: F40PF

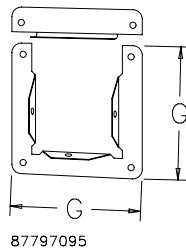

Catalog Number	G (in.)	G (mm)
F22G0A	4.50	114
F44G0A	6.00	152
F66G0A	8.00	203
F88G0A	10.00	254
F1010G0A	12.00	305
F1212G0A	14.00	356

Panel Adapter

A flanged fitting which allows the wireway to be securely connected to an enclosure.

Bulletin: F40PF

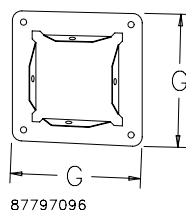

Catalog Number	G (in.)	G (mm)
F22GPA	4.50	114
F33GPA	5.00	127
F44GPA	6.00	152
F66GPA	8.00	203
F88GPA	10.00	254
F1010GPA	12.00	305
F1212GPA	14.00	356

Lay-In NEMA Type 1 Hinged-Cover Wireway

Closure Plate

Closes the end of a wireway section or run.

Bulletin: F40PF

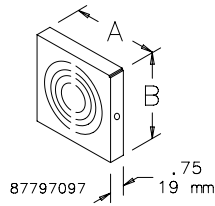

Catalog Number	AxB in.	AxB mm	Knockouts
F22GCP	2.50 x 2.50	64 x 64	With knockouts
F22GCPNK	2.50 x 2.50	64 x 64	Without knockouts
F44GCP	4.00 x 4.00	102 x 102	With knockouts
F33GCPNK	3.00 x 3.00	76 x 76	Without knockouts
F44GCPNK	4.00 x 4.00	102 x 102	Without knockouts
F66GCP	6.00 x 6.00	152 x 152	With knockouts
F66GCPNK	6.00 x 6.00	152 x 152	Without knockouts
F88GCP	8.00 x 8.00	203 x 203	With knockouts
F88GCPNK	8.00 x 8.00	203 x 203	Without knockouts
F1010GCP	10.00 x 10.00	254 x 254	With knockouts
F1010GCPNK	10.00 x 10.00	254 x 254	Without knockouts
F1212GCP	12.00 x 12.00	305 x 305	With knockouts
F1212GCPNK	12.00 x 12.00	305 x 305	Without knockouts

Reducer

Reduces wireway to a smaller size.

Bulletin: F10, F40PF

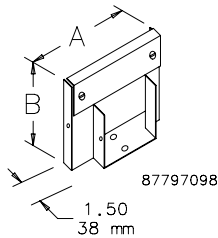

Catalog Number	AxB in./mm
F33G22R	3.00 x 3.00 76 x 76
F44G22R	4.00 x 4.00 102 x 102
F44G33R	4.00 x 4.00 101 x 101
F66G44R	6.00 x 6.00 152 x 152
F88G66R	8.00 x 8.00 203 x 203
F1010G88R	10.00 x 10.00 254 x 254
F1212G88R	12.00 x 12.00 305 x 305
F1212G1010R	12.00 x 12.00 305 x 305

Drop and Bracket Hangers

Drop and bracket hangers support a wireway run.

Bulletin: F40PF

Catalog Number	N max. (in.)	N max. (mm)	P (in.)	P (mm)	R (in.)	R (mm)	S (in.)	S (mm)	T (in.)	T (mm)
F22GDB	8.50	216	4.50	114	3.38	86	7.25	184	3.75	95
F44GDB	10.50	267	6.00	152	4.12	105	9.25	235	4.50	114
F66GDB	15.00	381	7.12	181	5.12	130	13.75	349	5.50	140
F88GDB	21.00	533	10.81	275	7.00	178	13.75	349	7.75	197
F1010GDB	22.00	559	13.81	335	8.38	213	13.75	349	10.25	260
F1212GDB	23.00	584	15.56	395	9.78	248	13.75	349	12.50	318

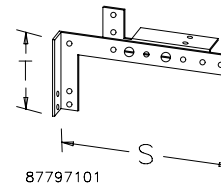
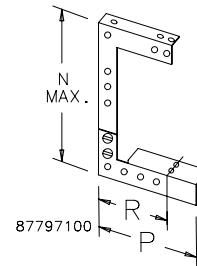

Lay-In NEMA Type 1 Hinged-Cover Wireway

Support Hanger

For floor or wall installations.

Bulletin: F40PF

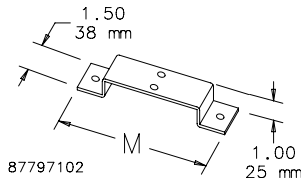

Catalog Number	AxB in./mm	M in./mm
F22GSH	2.50 x 2.50 64 x 64	4.62 117
F44GSH	4.00 x 4.00 102 x 102	6.12 155
F66GSH	6.00 x 6.00 152 x 152	8.12 206
F88GSH	8.00 x 8.00 203 x 203	10.12 257
F1010GSH	10.00 x 10.00 254 x 254	12.12 308
F1212GSH	12.00 x 12.00 305 x 305	14.12 359

Universal U-Connector

Joins wireway sections and fittings. Top swings aside to retain the lay-in feature. One U-connector required at each wireway joint except telescope fittings, panel adapters, open adapters, closure plates or reducers.

Bulletin: F40PF

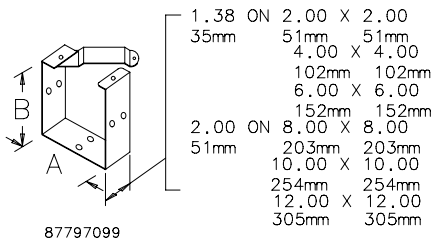

Catalog Number	AxB in./mm
F22GUC	2.50 x 2.50 64 x 64
F33GUC	3.00 x 3.00 76 x 76
F44GUC	4.00 x 4.00 102 x 102
F66GUC	6.00 x 6.00 152 x 152
F88GUC	8.00 x 8.00 203 x 203
F1010GUC	10.00 x 10.00 254 x 254
F1212GUC	12.00 x 12.00 305 x 305

Barrier Kit, Bolt-On

Divides wireway into two or more compartments. Barriers are fastened to wireway sections with screws. Sealing washers are included.

Bulletin: F20

Catalog Number	AxB in./mm	W in./mm
F33BK60	3.00 x 3.00 76 x 76	2.00 51
F44BK60	4.00 x 4.00 102 x 102	3.00 76
F66BK60	6.00 x 6.00 152 x 152	4.50 114
F88BK60	8.00 x 8.00 203 x 203	6.00 152

