

OPERATION, SERVICE AND PARTS INSTRUCTION MANUAL

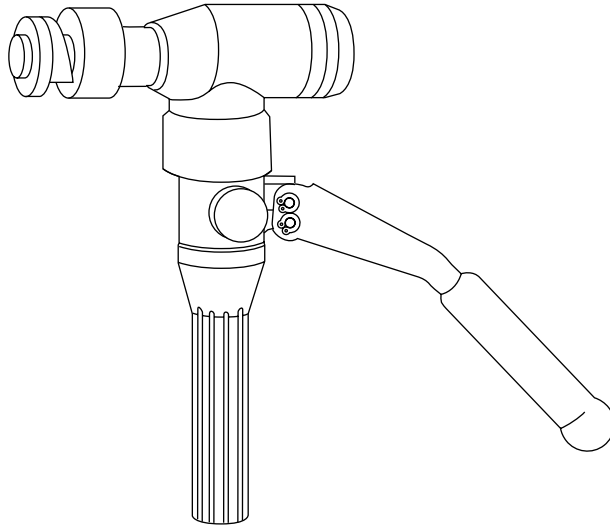

7904SB/7906SB QUICK DRAW 90TM HYDRAULIC PUNCH DRIVER

For units with serial code "WV"



Read and understand this material before operating or servicing this equipment. Failure to understand how to safely operate this tool could result in an accident causing serious injury or death.

Table of Contents

Description	2
Important Safety Instructions	3-4
Specifications	5
Capacity And Draw Stud Selection Guide	6
Operation	7-9
Maintenance	10-12
Troubleshooting	13-14
Exploded View	15
Parts List	16
Draw Studs and Accessories	17

Description

The Quick Draw 90™ is a self-contained hydraulic punch driver. The Quick Draw 90™ and Greenlee punches, dies, and draw studs form a complete system for punching holes of various shapes and sizes through mild steel, aluminum, fiberglass and plastic. Slug-Splitter® punches, dies and studs are available for punching all of these materials and stainless steel.

Various Quick Draw™ kits are available:

7904SB	Quick Draw™ Hydraulic Punch Driver, draw studs
7906SB	Quick Draw™ Hydraulic Punch Driver, draw studs, conduit-size punches and dies
7904E	Quick Draw™ Hydraulic Punch Driver and draw studs
7904ESB	Quick Draw™ Hydraulic Punch Driver, draw studs, Pg size punches and dies
7904ISO	Quick Draw™ Hydraulic Punch Driver, draw studs, ISO size punches and dies

IMPORTANT SAFETY INSTRUCTIONS



SAFETY ALERT SYMBOL

The symbol above is used to call your attention to instructions concerning your personal safety. Watch for this symbol. It points out important safety precautions. It means Read the message that follows and be alert to the possibility of personal injury or death.

⚠ DANGER

Immediate hazards which, if not avoided, **WILL** result in severe personal injury or death.

⚠ WARNING

Hazards or unsafe practices which, if not avoided, **COULD** result in severe personal injury or death.

⚠ CAUTION

Hazards or unsafe practices which, if not avoided, **COULD** result in minor personal injury or property damage.

Safety is a critical factor in the design of Greenlee equipment. The best program starts with a safety-conscious operator. The information highlighted in this bulletin describes operating practices for the benefit of the workers who will use our equipment in their daily jobs. Comments from users are appreciated.

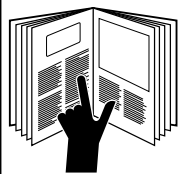

⚠ WARNING

A person who has not read and does not understand all operating instructions is not qualified to operate this tool.

Failure to read and understand safety instructions may result in injury or death.

SAVE THESE INSTRUCTIONS

Additional copies of this manual are available upon request at no charge.

IMPORTANT SAFETY INSTRUCTIONS

	⚠ WARNING
	Electric shock hazard: Do not use near live circuits. Contact with live circuits can result in severe injury or death.

⚠ WARNING
Do not operate the pump lever after the ram motion stops. Continuing to operate the pump lever after the ram motion stops will damage the driver and could propel internal parts with great force, striking nearby personnel.

⚠ WARNING
<ul style="list-style-type: none">• Do not exceed the rated capacity of the tool. Exceeding the capacity of the tool could cause tool or component to break and strike nearby personnel.• Do not add extensions or cheaters to the handles. Using cheaters or applying more than 80 pounds (356 N) of handle force will damage the driver and could propel internal parts with great force, striking nearby personnel.• Do not allow anyone to stand directly in front of the punch. A component failure could propel the punch and draw stud with great force, and could strike nearby personnel.• Use only Greenlee punches, dies, and draw studs. Other punches, dies, and draw studs may not withstand the force capacity of the driver and could break, striking nearby personnel.

⚠ WARNING
<ul style="list-style-type: none">• Inspect tool for wear or damage. Replace any worn, damaged, or missing components with Greenlee replacement parts. A damaged or improperly assembled tool can break and strike nearby personnel with sufficient force to cause severe injury or death.• Inspect the punch, die, draw stud and spacers for wear or damage. Replace any worn or damaged items with Greenlee replacement parts. Replace any punches that have dull cutting surfaces.

⚠ CAUTION
Use this tool for manufacturer's intended use only. Use other than that which is described in this manual can result in injury or property damage.

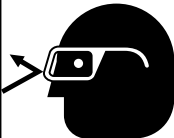
	⚠ WARNING
	Wear eye protection when using this tool. Failure to wear eye protection can result in serious eye injury from flying debris or hydraulic oil.

SAVE THESE INSTRUCTIONS

Additional copies of this manual are available upon request at no charge.







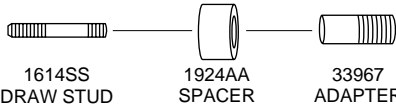

Capacity and Draw Stud Selection Guide

 14 Ga. (0.0747" [1.9 mm])
Mild Steel

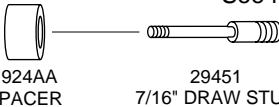
 10 Ga. (0.1345" [3.4 mm])
Stainless Steel

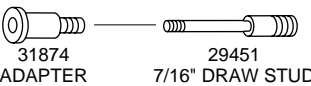
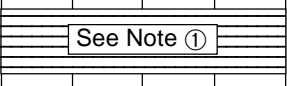
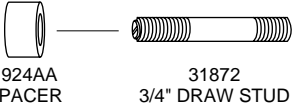
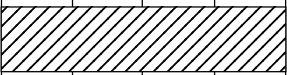
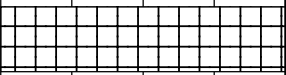
 10 Ga. (0.1345" [3.4 mm])
Mild Steel

 16 Ga. (0.0598" [1.5 mm])
Mild Steel & 1/18" Soft Aluminum

Stud and Accessories	Standard & Slug-Buster® Punches						Slug-Splitters®					Electronic Connector Punches RS-232, 229, 231, 234, 238.	
	1/2" con. Ø 0.885" 15.2 mm	3/4" con. Ø 1.115" 28.3 mm	1-7/32"	1" con. Ø 1.362" 34.6 mm	1-1/4" con. Ø 1.701" 43.2 mm	1-1/2" con. Ø 1.951" 49.6 mm	2" con. Ø 2.416" 61.5 mm	1/2" con. Ø 0.885" 15.2 mm	3/4" con. Ø 1.115" 28.3 mm	1-7/32"	1" con. Ø 1.362" 34.6 mm		1-1/4" con. Ø 1.701" 43.2 mm
 <p>1614SS DRAW STUD 1924AA SPACER 33967 ADAPTER</p>													
 <p>1924AA SPACER 29451 7/16" DRAW STUD</p> <p>See Note ②</p>													
 <p>31874 ADAPTER 29451 7/16" DRAW STUD</p> <p>See Note ②</p>													
 <p>1924AA SPACER 31872 3/4" DRAW STUD</p>													
 <p>31872 3/4" DRAW STUD</p>													
 <p>33967 ADAPTER</p>													

① The Slug-Buster® punches may not split the slug when used with this adapter, because of the smaller pilot hole.

② The 31874 step-saver adapter and 29451 draw stud are included with the 7804SB only. They may be purchased separately and used with any Quick-Draw™ hydraulic punch driver kit.

Operation

The 1/2" conduit-size punch is often used to increase the size of the pilot hole; this is called "step-up punching". After enlarging the pilot hole, the 3/4" draw stud is used to punch the final hole. See steps 1-6.



1. Drill 1/2" pilot hole using a Greenlee Kwik-Stepper® step bit.



2. Turn the release valve counterclockwise to make sure the ram is fully extended. Install 3/8" draw stud, 3/4" x 3/8" adapter, spacer and 1/2" conduit die and insert into pilot hole.



3. Thread 1/2" conduit punch onto draw stud until the punch is tight. Make sure the draw stud threads are fully engaged in the punch.



4. Turn the release valve knob clockwise. Rotate driver to best operating position, and then pump lever handle until the punch is completely through the material.



5. Release by turning release valve knob counterclockwise and remove the punch, die, adapter and draw stud.

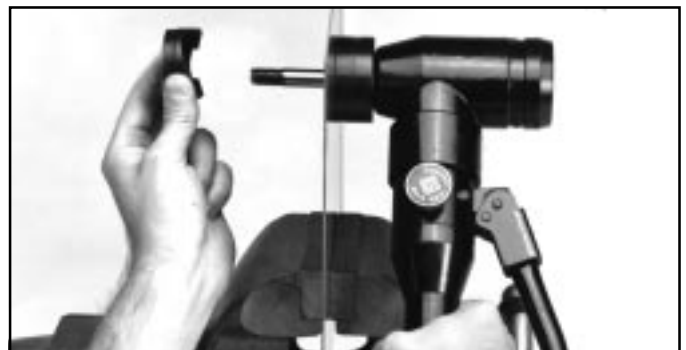

6. Install 3/4" draw stud and select proper size punch and die for desired size hole and repeat steps 4 and 5.

Operation (cont'd)

Using the 29451 draw stud and optional 31874 step-saver adapter

After drilling the pilot hole, use the 29451 draw stud and 31874 step-saver adapter as shown here. These components eliminate the need for step-up punching.

Note: The stud and adapter are rated to drive the 1-1/4" punch through 14 gauge mild steel .

⚠ WARNING

Do not exceed the rated capacity of the 29451 draw stud and 31874 step-saver adapter. Exceeding the maximum rated capacity could cause the stud and adapter to break and strike nearby personnel.



1. Drill 1/2" pilot hole using Greenlee Kwik-Stepper® step bit.



2. Thread the adapter into the punch.



3. Thread 7/16" draw stud tightly into driver. Place the die on the draw stud.



4. Turn the release valve knob counterclockwise, to make sure the draw stud is fully extended. Insert stud through pilot hole.

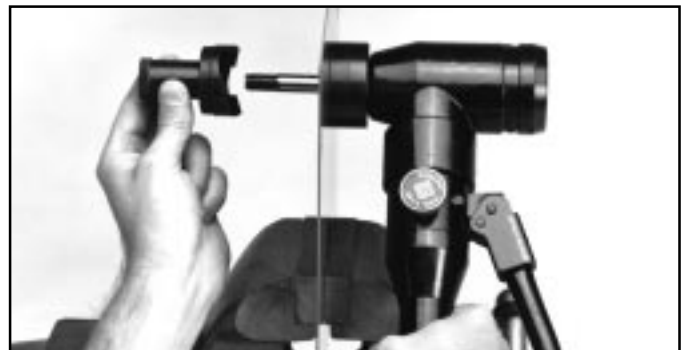

5. Thread the adapter with punch onto the draw stud.

Operation (cont'd)

Using the 29451 draw stud and optional 31874 step-saver adapter (cont'd)



6. Make sure draw stud threads are fully engaged in the adapter.



7. Turn release valve knob clockwise. Pump lever handle until the punch is completely through the material.



8. Release by turning the release valve knob counter-clockwise.



9. Remove punch and die.

Maintenance

Maintenance and repairs should be performed in a dust free area by qualified technicians.

This unit requires minimum maintenance because it has a closed hydraulic system and all internal parts are lubricated by the hydraulic fluid. Lubricate lever pins lightly. Keep contaminants away from ram and housing. Store with lever down and hydraulic pressure released.

Adding Hydraulic Oil

1. Place driver in vise in vertical position with handles up. Unscrew reservoir handle (21) and remove bladder plug (20). Open release valve knob (27) to assure the ram is fully extended.
2. Fill bladder (29) to point of overflow with Greenlee hydraulic oil.
3. Purge air from system:

Pump handle (22) several times to remove air from the pumping chamber. Close release valve knob and pump handle until ram (3) completes its full travel. Repeat as necessary.

Note: Open release valve knob slowly so ram extends slowly. Rapid return of oil and air may cause oil to overflow the bladder.

If this procedure fails to remove air, remove bladder plug and open release valve knob. Place thumb over plug hole in bladder and squeeze bladder while pumping handle several times. Close the release valve knob and pump the handle until the ram completes its full travel. Repeat as necessary.

If this procedure does not remove air, remove plunger (24) and fill plunger cavity with clean oil as outlined in Reassembly in the Maintenance section of this manual.

4. Fill rubber bladder to the point of overflow and replace bladder plug. Wipe bladder clean of excess oil and reassemble reservoir handle.

Troubleshooting And Repair

To function properly, the punch driver must be free of oil leaks, must build oil pressure, and the ram section (right angle head) must rotate by hand force.

Oil Leaks

Check for external oil leaks.

Check that release valve knob and stem are closed tightly and seating properly.

Remove reservoir handle (21) and check for oil leaks around bladder (29) and bladder plug (20).

Failure to Build Pressure

Fill with oil and purge air from the system. See Adding Hydraulic Oil.

Ram Section Will Not Rotate

Loosen and readjust set screw (13). Hold punch driver with ram section up. Apply small amount of penetrating oil to cylinder (1) at the attachment point, then work ram section back and forth. Apply a small amount of SAE 30 oil to cylinder collar next to the pump block.

Rebuilding

If no leaks are visible and the unit will not build oil pressure, disassemble and rebuild the punch driver.

Disassembly—Pump

Note: Separate ram section from pump section. Remove set screw (13). Unscrew ram section from pump section.

1. Remove reservoir handle (21), and bladder plug (20); drain oil from the bladder (29).
2. Remove O-ring (35) and the bladder (29). Remove retaining rings (37) from one end of both handle pins (30) and remove handle pins and handle (22).
3. Grasp plunger (24) with pliers; pull and twist to remove. Loosen set screw (12) from release valve knob (27); remove knob. Unscrew the release stem (28) to remove from pump block (2).
4. Unscrew intake check seat (23); remove ball (32), compression spring (31) and copper washer (40).
5. Unscrew the discharge check retainer (26). Remove spring (39) and ball (5).

Disassembly—Ram

Note: See illustration on next page.

1. Loosen set screw (12). Unscrew spring retainer (4) from ram housing (1). Remove compression spring (7).
2. Screw a draw stud into end of ram (3); push the ram out of the cylinder (1).

You have now disassembled the punch driver. Thoroughly clean all parts and inspect the three ball seats (intake, discharge and release stem) for nicks, scratches, or other damage.

Maintenance (cont'd)

Ball Seat Repair

Re-seating:

Minor seat imperfections may be corrected by re-seating. Use a soft brass rod and hammer to tap the ball against its seat.

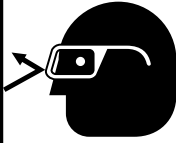
	<p>WARNING</p>
	<p>Wear eye protection when servicing this tool.</p> <p>Failure to wear eye protection can result in serious eye injury from flying debris or hydraulic oil.</p>

Re-drilling:

Badly worn or damaged seats may be reworked by re-drilling and then re-seating.

The pump block is manufactured with seats of 118°, the standard drill point angle; use standard drills for re-drilling.

- To re-drill the 7/32" ball seat for release stem (28): Use an "I" drill and a 9/64" diameter reamer.
- To re-drill the 7/32" ball seat for the discharge check: Use an "I" drill and a 5/32" diameter reamer.
- To re-drill the 3/16" ball seat for the intake check: Use a 1/4" drill and a 1/8" diameter reamer.

When drilling; remove a minimum of material to obtain maximum seat life. Re-seat the balls before reassembly.

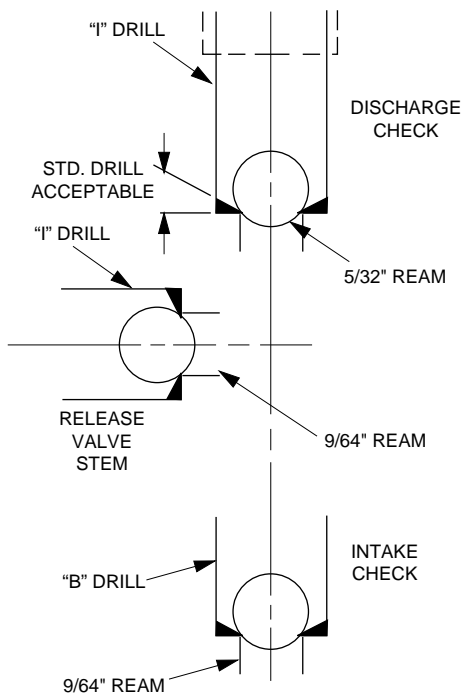

Reassembly

Reassembly is done in reverse sequence of disassembly. Inspect all O-ring seals for cuts and wear; replace as needed.

Reassembly—Ram Section

1. Lightly coat ram (3) and cylinder (1) seals, and both bores of the cylinder with clean oil.
2. Push ram completely into cylinder.
3. Thread installation rod into tapped hole in the ram and install compression spring (7). Place spring retainer (4) on top of spring (7) so the installation rod passes through the 1/4" hole in the spring retainer.
4. Place a flat washer and thread a hex nut on the installation rod. Tighten the nut until the spring retainer threads contact the cylinder threads; screw the spring retainer into the cylinder.
5. Remove the installation rod. Screw the spring retainer approximately one thread below the surface of the cylinder. Rotate the spring retainer (4) until travel distance is .830" (21.1 mm) to .930" (23.6 mm). Tighten the set screw (12).

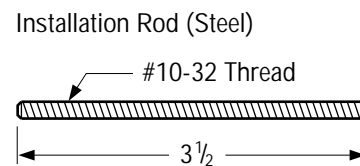
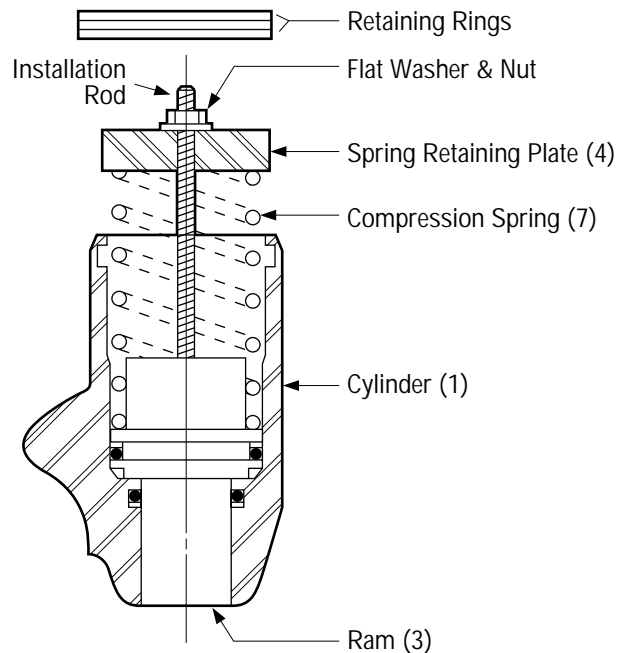

Maintenance (cont'd)

Reassembly—Pump Section

Fill plunger (24) bore with clean hydraulic oil. Coat O-ring seals on plunger with clean oil and reinsert the pump block (2) with release valve knob (27) closed.

Reassembly—Ram to Pump

1. Apply clean hydraulic oil to the O-ring (14) groove on the 1/2" diameter "stem" of the cylinder, and the mating bore of pump block.
2. Apply a light coat of grease (Molycote G) to the external threads of cylinder (1) and both ends of the compression spring (41). Position the pump block with the threaded end up and place the compression spring (41) into the pump block recess.
3. Insert the cylinder stem into mating bore of pump block, compress the spring (41), and thread the pump block onto the cylinder.
4. Apply Loctite 242 or equivalent to set screw (13) and install until set screw bottoms. Back out the set screw 1/8 to 1/4 turn.
5. Fill unit with clean oil and purge air. See Adding Hydraulic Oil.

Inspection and Adjustments

After reassembly, check the following:

Ram Travel Inspection

Ram Extended

With the draw stud removed and release valve knob open, observe whether end of ram (3) is flush to 1/64" (.396 mm) below the end of cylinder (1). If it is not, the bladder (29) contains too much oil.

To remove excess oil:

1. Remove reservoir handle (21) and bladder plug (20).
2. Slowly open release valve knob (27); excess oil should come out of the bladder and the ram should move to become flush to 1/64" (.396 mm) below the end of the cylinder (1).
3. If excess oil does not come out, replace the compression spring (7).

Ram Retracted

Measure ram travel distance (difference between ram completely extended and completely retracted). Rotate spring retainer (4) until travel distance is .830" (21.1 mm) to .930" (23.6 mm). Tighten set screw (12).

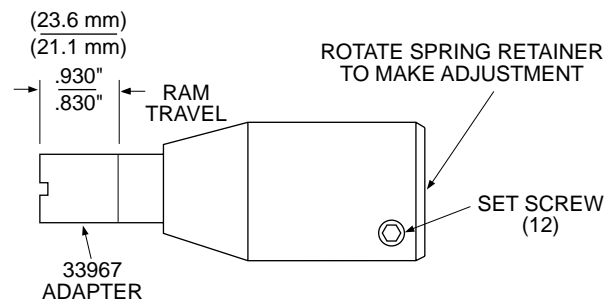

Pump Section Inspection

Intake Check Valve

Close the release valve knob and operate handle (22) until ram (3) bottoms and handle resistance increases.

- If the ram bottoms in 30 strokes or less, the intake check valve is operating properly.
- More than 30 strokes indicates an intake check leak. Re-seat, re-drill or replace the copper washer (40), and compression spring (31).

Discharge Check Valve

If the handle (22) returns to the raised position by itself, the discharge check valve is leaking. Re-seat or re-drill the discharge check seat and replace the compression spring (39).

Release Valve

Pump the handle until the ram bottoms. Gently apply and maintain additional force on handle (22). If the handle remains solid, the ball (32) is operating properly. If the handle (22) goes down slowly, the release valve is leaking. Re-seat or re-drill the release stem seat and replace O-ring (33).

Cylinder Rotation

Install a 3/4" draw stud and a 2" conduit size punch and die to the punch driver. Hold the driver by the reservoir handle (21) so the draw stud is horizontal; the cylinder should not rotate from the combined weight of the draw stud, the punch and the die. Replace compression spring (31).

If binding or roughness occurs during cylinder rotation, check for lubrication or damage at threads closest to set screw (13); also check adjustment of set screw (13).

Troubleshooting

PROBLEM	PROBABLE CAUSE	POSSIBLE REMEDY
Will not punch hole.	Improper assembly or use of punch, die or accessories.	See Operating Instructions and Capacity Chart. Low oil level. See Adding Hydraulic Oil in Maintenance Section.
Requires excessive lever force.	Improper assembly or use of punch, die or accessories.	See Operating Instructions and Capacity Chart. Material being punched is too thick or too hard. See Capacity Chart.
Pump will not build pressure.	Air in system.	See step 3, Adding Hydraulic Oil.
Excessive number of strokes strokes are required to punch hole.	Inoperative intake check valve.	See Inspection and Adjustments, Intake Check Valve Inspection.
	Inoperative discharge check valve.	See Inspection and Adjustments, Discharge Check Valve Inspection.
	Leaking Release Valve.	See Inspection and Adjustments, Release Valve Inspection.
	Damaged piston, piston extension, pump plunger seals or mating surfaces.	See Maintenance and Repairs, Cylinder and Pump Block sections.

Troubleshooting (cont'd)

PROBLEM	PROBABLE CAUSE	POSSIBLE REMEDY
Will not return piston.	Weak or damaged return spring, excess oil in unit.	See Piston Travel Inspection.
External oil leaks.	Damaged seals or surfaces.	<p>Damaged piston, piston extension, pump plunger seals or mating surfaces. See Troubleshooting and Repair, Cylinder and Pump Block sections.</p> <p>Damaged Release Valve Stem seal. See Inspection and Adjustments, Release Valve Inspection.</p>

Exploded View
Serial Code WV

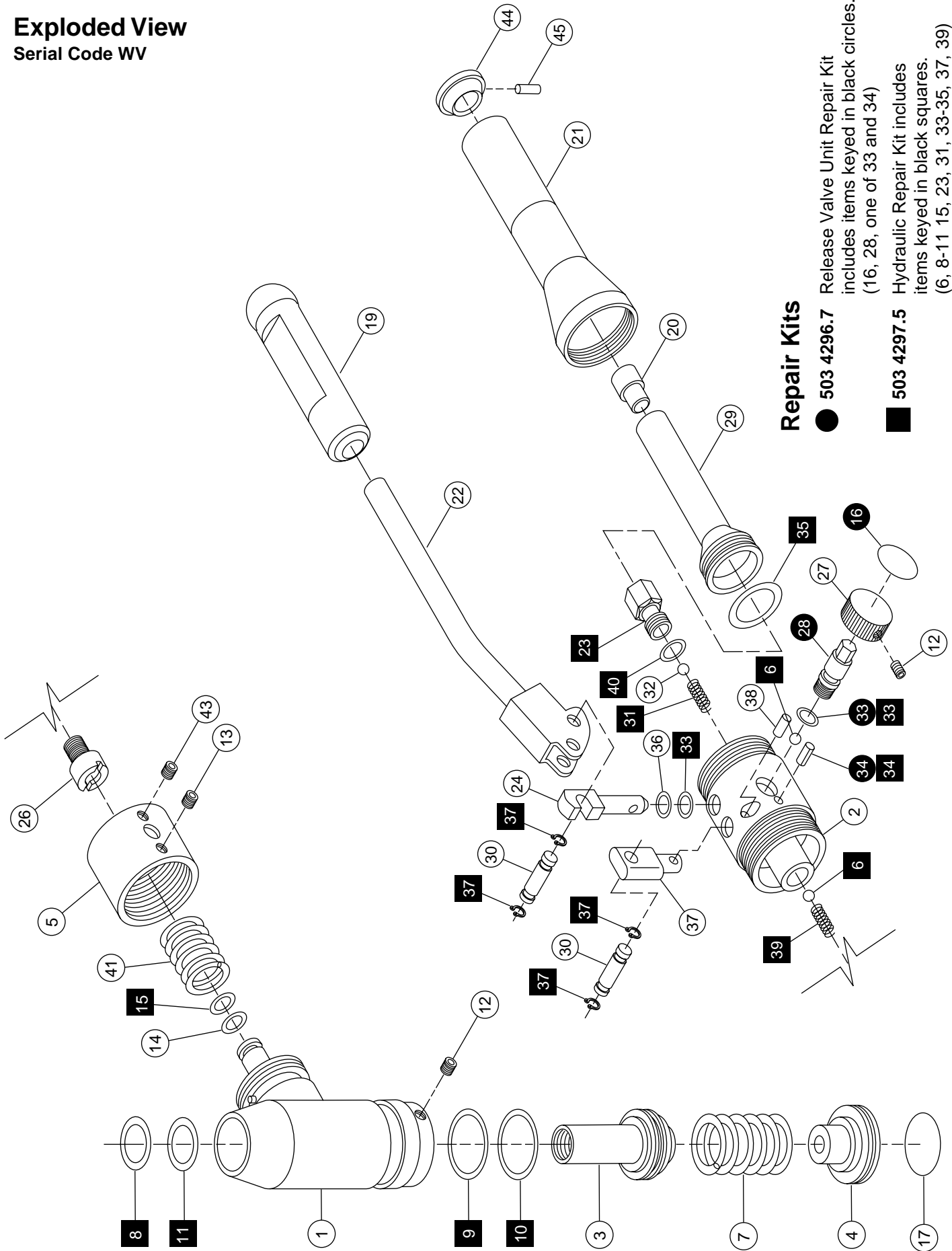

Repair Kits

- **503 4296.7** Release Valve Unit Repair Kit includes items keyed in black circles. (16, 28, one of 33 and 34)
- **503 4297.5** Hydraulic Repair Kit includes items keyed in black squares. (6, 8-11 15, 23, 31, 33-35, 37, 39)

Parts List

KEY	PART NO.	DESCRIPTION	QTY.
1	503 5408.6	Cylinder, angle driver	1
2	503 4273.8	Block, pump	1
3	503 3790.4	Ram, right angle driver	1
4	503 3791.2	Retainer, spring	1
5	503 3792.0	Collar	1
6	905 0292.2	Ball, steel, .218 diameter	2
7	503 3907.9	Spring, compression, 1.34 x 1.65 x 1.76	1
8	905 3847.1	Back-up ring, spiral, 1.00 x 1.24 x .027 Teflon	1
9	905 1316.9	O-ring, 1.50 x 1.75 x .125 Nitrile	1
10	905 3849.8	Back-up ring, spiral, 1.50 x 1.74 x .027 Teflon	1
11	905 1330.4	O-ring, 1.00 x 1.25 x .125 Nitrile	1
12	905 1032.1	Screw, set, #8–32 x .187 socket cup point	2
13	905 3771.8	Screw, set, 1/4–28 x .250 socket	1
14	905 3850.1	Back-up ring, .375 ID	1
15	905 0168.3	O-ring, .375 x .500 x .062	1
16	503 1878.0	Decal	1
17	503 4301.7	Decal, identification	1
19	502 3258.4	Grip, .600 x 1.00 x 4.50	1
20	503 2488.8	Plug, bladder	1
21	503 4281.9	Handle, reservoir	1
22	503 4285.1	Handle, pump	1
23	503 4275.4	Seat, intake check	1
24	503 4268.1	Plunger	1
25	503 4274.6	Fulcrum post	1
26	503 4276.2	Retainer, discharge check	1
27	503 4266.5	Knob, release valve	1
28	503 4265.7	Stem, release	1
29	503 4269.0	Bladder	1
30	503 4286.0	Pin, handle	2
31	503 4287.8	Spring, compression intake	1
32	905 0678.2	Ball, steel, .187 diameter	2
33	905 3854.4	O-ring, .250 x .375 x .062	2
34	905 0458.5	Pin, roll, .125 x .375	1
35	905 1456.4	O-ring, 1.12 x 1.31 x .093 Nitrile	1
36	905 3853.6	Back-up ring, .250 ID	1
37	905 3844.7	Retaining ring	4
38	905 3846.3	Pin, Drive-Lok, .25ø x 1.00	1
39	905 3845.5	Spring, compression, .152 x .180 x .380	1
40	905 3852.8	Washer, copper	1
41	905 3869.2	Spring, compression	1
43	905 0753.3	Screw, set 1/4–28 x .187 socket	1
44	503 4278.9	Cap, reservoir handle	1
45	905 3855.2	Pin, drive, .125 diameter	1

Draw Studs and Accessories

CATALOG NO.	PART NO.	DESCRIPTION	QTY.
29451	502 9451.2	Draw stud, 7/16" stainless steel (optional)	1
31872	503 1872.1	Draw stud, 3/4-16 x 4.12	1
31874	503 1874.8	Adapter, step-saver (optional)	1
1924AA	500 3248.8	Spacer, .767 x 1.37 x .875	1
1614SS	503 0043.1	Screw, 3/8" short adapter	1
33967	503 3967.2	Adapter, stud, 3/8-24 x 3/4-16	1

GREENLEE **TEXTRON**

Greenlee Textron / Subsidiary of Textron Inc.

4455 Boeing Drive, Rockford, IL 61109-2988 USA

General Offices: 815/397-7070

Customer Center and Field Service: 800/435-0786

International Customer Service: 815/397-7070

Fax (24 Hour) Customer Center: 800/451-2632 • 815/397-1865

Canada Fax (24 Hour) Customer Center: 800/524-2853

Fax (24 Hour) International Customer Service: 815/397-1391

Printed in the U.S.A.