

**Middle Atlantic Products**

EXCEPTIONAL SUPPORT &amp; PROTECTION™

# RL Series Open Frame Racks

**EIA/TIA Compliant**

## The RL Series 19" Open Frame Rack Self-squaring design greatly speeds assembly

### Features

- Self-aligning design speeds field assembly
- 1,600 lb. weight capacity
- 11-gauge steel channels available 10-32 or 12-24 threaded
- Gusseted foot base with taper on feet allows rack to self-stabilize on uneven floors
- Space between feet allows for placement of devices on floor close to rack (eg. UPS, etc.)
- 1/8" aluminum top angles, which can be easily field drilled for cable ladder installation
- Includes 50 qty. rack screws
- Durable black powder coat finish

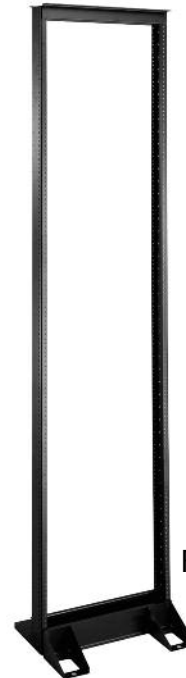

RL10-45



(2) RL10-45 shown with optional cable organizers and covers

#### OPEN FRAME RACK ACCESSORIES

 CANTILEVER SUPPORT BASE  
 CENTER CABLE ORGANIZER  
 END CABLE ORGANIZER  
 CABLE ORGANIZER COVERS

### Architects' and Engineers' Specifications

EIA compliant 19" open frame rack shall be Middle Atlantic Products model # RL-\_\_ (refer to chart) with self-aligning design to speed field assembly. Overall dimensions of rack shall be 19.62" W x 15.25"D (5.5" deep at top) x \_\_" H, with a useable rack height of \_\_ rackspace (refer to chart). Weight capacity shall be 800 lbs., evenly distributed with the base securely fastened, and 1600 lbs., evenly distributed with the base of the rack securely fastened and the top of the rack braced to a structural building component (Note: Installation of open frame racks can vary widely with all types of conditions. Please note that mounting equipment in cantilever fashion, which effectively changes the center of gravity of the rack, will lessen the overall ability of the rack to bear weight). Relay rack channels shall be constructed of 11-gauge steel with tapped \_\_\_\_\_ (10-32 or 12-24, refer to chart) holes in universal EIA spacing, top angles shall be 0.125" thick aluminum which can be easily field drilled for cable ladder installation. Gusseted foot base shall have taper on feet to allow rack to self-stabilize on uneven floors. Open frame rack shall be finished in a durable black powder coat. Open frame rack shall be GREENGUARD

Indoor Air Quality Certified for Children and Schools. Open frame rack shall be RoHS EU Directive 2002/95/EC compliant. Open frame rack shall be manufactured by an ISO 9001 and ISO 14001 registered company. Open frame rack shall be warranted to be free from defects in materials or workmanship under normal use and conditions for the lifetime of the rack.

#### OPTIONS

- CSB Cantilever support base
- CK-45 Center cable organizer (45 space)
- CK-45E End cable organizer (45 space)
- CK-45C Cable organizer covers (45 space)

**CUSTOMIZABLE SPECIFICATION CLIPS AVAILABLE AT MIDDLEATLANTIC.COM**

# RL basic dimensions

All dimensions in inches unless otherwise noted [bracketed dimensions in millimeters]

## RL SERIES OPEN FRAME RACK

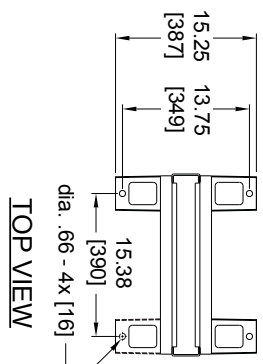

TOP VIEW

Part #	A OVERALL HEIGHT	B USABLE RACKSPACES	THREAD TYPE
RL10-45	84.62 [2149]	45	10-32
RL10-38	72.37 [1838]	38	10-32
RL12-45	84.62 [2149]	45	12-24

## CK SERIES CABLE ORGANIZERS (45 SPACE OPEN FRAME RACKS ONLY)

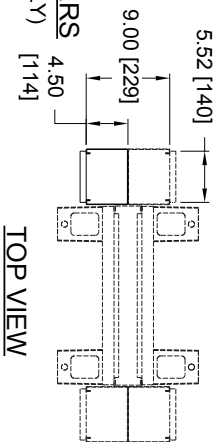

TOP VIEW

NOTE: CK-45 shown (open for center use). CK-45E features one solid side (closed for end use).

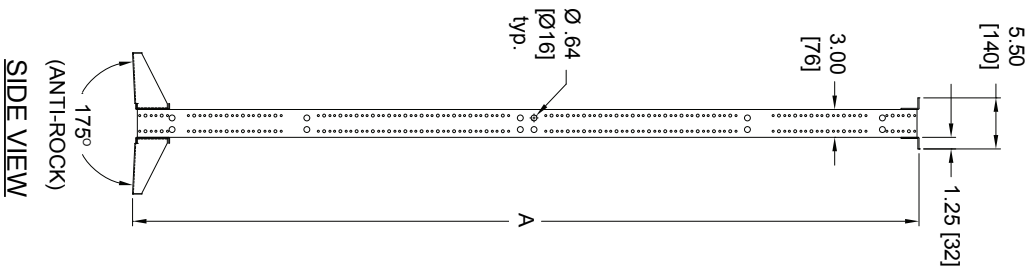

SIDE VIEW

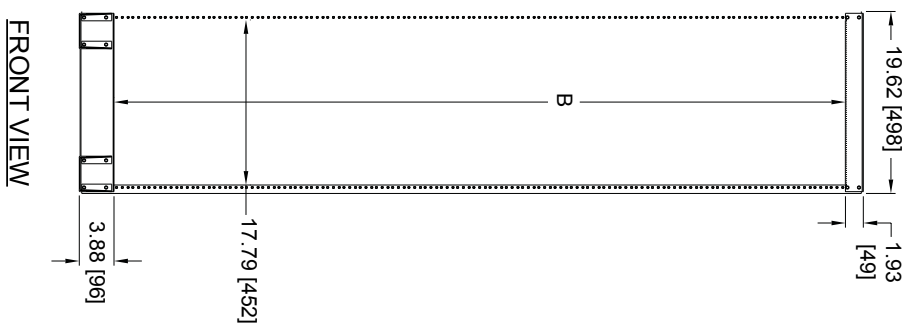

FRONT VIEW

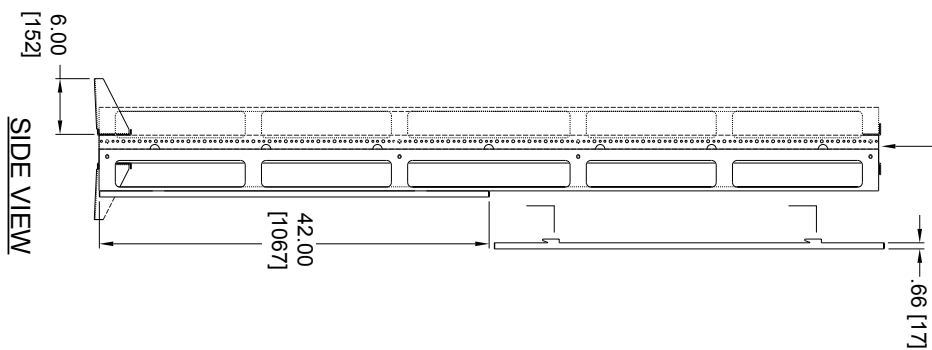

SIDE VIEW

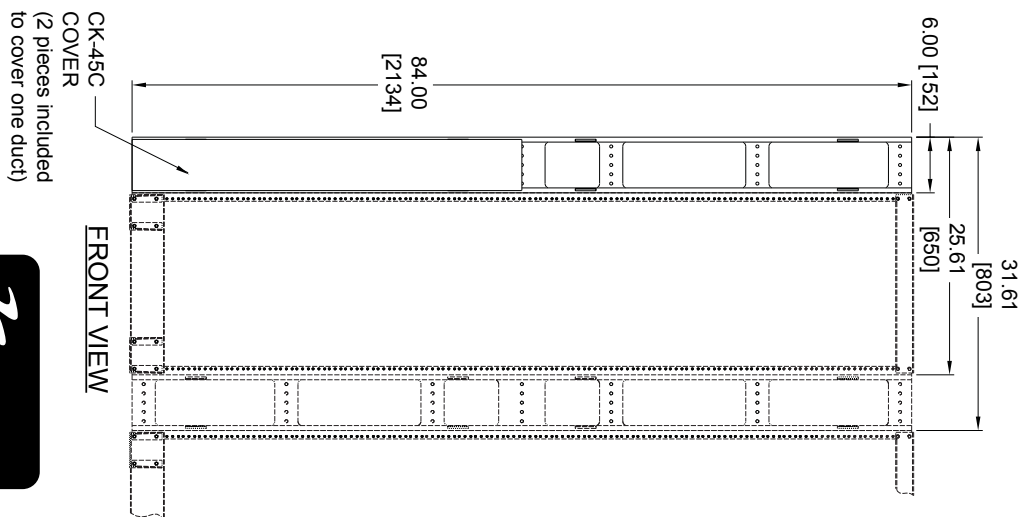

FRONT VIEW

CK-45C  
COVER  
(2 pieces included  
to cover one duct)

