

READ ALL INSTRUCTIONS COMPLETELY BEFORE PROCEEDING

COMPONENT IDENTIFICATION

CONNECTOR ASSEMBLY

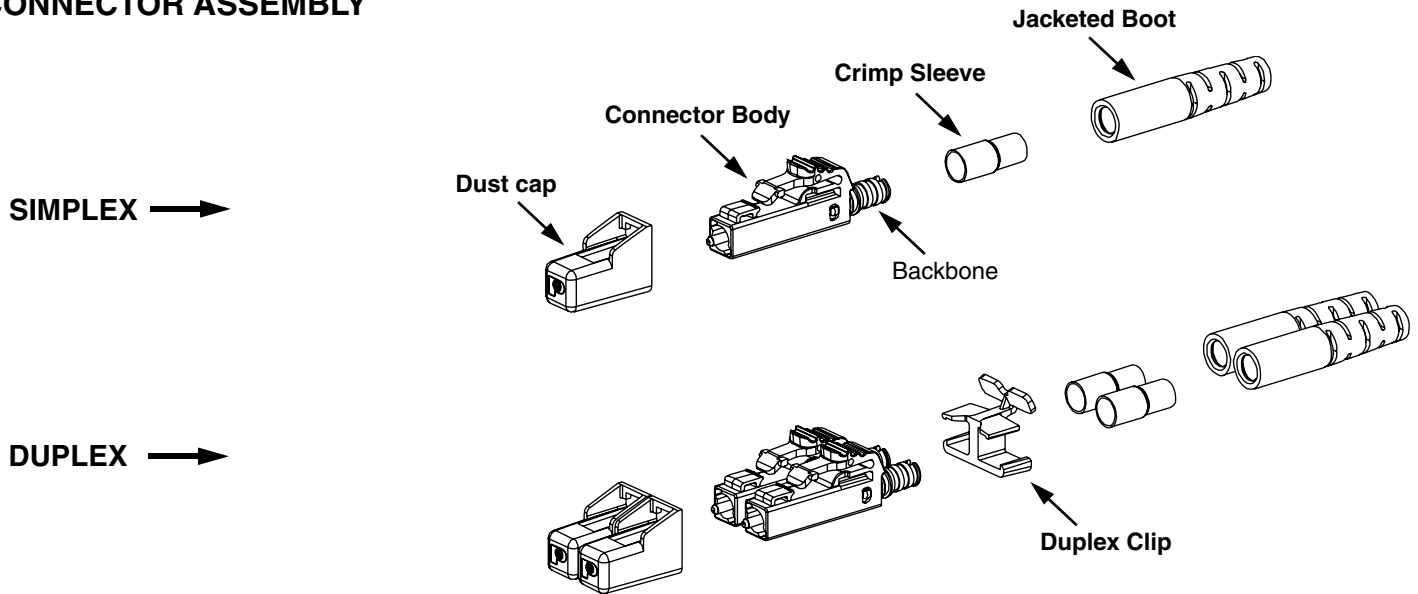

ITEMS REQUIRED FOR TERMINATION

ITEM	PART NUMBER	DESCRIPTION
1	CST-115	Fiber Cable Jacket Stripper
2	FALC	Alcohol Bottle (empty)
3	FBFSP	Fiber Buffer Stripper
4	FLPT	LC Crimp Tool
5	FSCRIBE	Carbide Scribe
6	FGLS	Safety Glasses
7	FLCPK	LC Polishing Puck (1.25mm Ferrule)
8	FJPMR	Primer
9	FJPXY	Anaerobic Adhesive
10	FKS	Aramid Yarn Shears
11	FPP5-L	5µm Polishing Film (Aluminum Oxide)
12	FPF1-V	1µm Diamond Polishing Film
13	FLCPAD	85 Durometer Polishing Pad
14	FSCDVR	Screwdriver
15	FSCOPE	200x Microscope
16	FLCASC	1.25mm Adapter for FSCOPE
17	FSTY	Safety Stickers for fiber scraps
18	FSWB-C	Cleaning Swabs
19	FSYR-X	Syringes with needle tips
20	FTWZR	Tweezers
21	FWP-C	Cloth Wipes
22	PFX-0	Indelible Ink Marking Pen
23	FLOUPEX10	Eye Loupe 10X Power
24	--	Isopropyl Alcohol (Reagent Grade, 90% minimum concentration; not available from Panduit)
25	FLCFPLF-X	.05µm Lapping Film (For singlemode terminations only)
26	FWBTL	Distilled Water Bottle (empty)
--	--	Distilled Water (not available from Panduit)
OPTIONAL	PN335*	LC Connector Stripping Template

* denotes stripping template revision letter.

For Technical Support: www.panduit.com/resources/install_maintain.asp

TABLE OF CONTENTS

Page(s)

Safety Precautions 2

3.0mm Jacketed Cable Termination..... 3-7

SAFETY PRECAUTIONS

1. SAFETY GLASSES

WARNING: IT IS STRONGLY RECOMMENDED THAT SAFETY GLASSES BE WORN WHEN HANDLING BARE OPTICAL FIBER. THE BARE FIBER IS VERY SHARP AND CAN EASILY DAMAGE THE EYE.

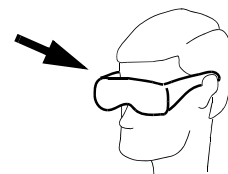

2. ISOPROPYL ALCOHOL

WARNING: ISOPROPYL ALCOHOL IS FLAMMABLE. CONTACT WITH THE ALCOHOL CAN CAUSE IRRITATION TO THE EYES. IN CASE OF CONTACT WITH THE EYES, FLUSH WITH WATER FOR AT LEAST 15 MINUTES. ALWAYS USE ISOPROPYL ALCOHOL WITH PROPER LEVELS OF VENTILATION. IN CASE OF INGESTION, CONSULT A PHYSICIAN IMMEDIATELY.

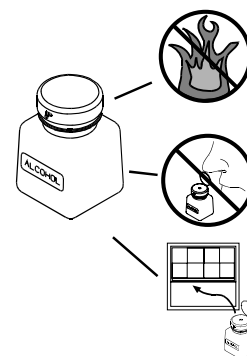

3. RECOMMENDED ADHESIVE AND PRIMER

WARNING: THE RECOMMENDED ADHESIVE (PANDUIT PART# FJPHY) MAY CONTAIN MALEIC ACID AND METHACRYLIC ESTER. IN CASE OF EYE CONTACT, FLUSH WITH WATER FOR 15 MINUTES AND GET MEDICAL ATTENTION. WASH SKIN AFTER CONTACT. REQUEST M.S.D.S. FOR FURTHER SAFEGUARDS. CHECK "USED BY" DATE ON BOTTLE TO ENSURE BEST PERFORMANCE.

WARNING: THE RECOMMENDED PRIMER (PANDUIT PART# FJPMR) MAY CONTAIN ACETONE. THE PRIMER IS HARMFUL IF INHALED OR SWALLOWED. IN CASE OF CONTACT WITH EYES OR SKIN, FLUSH WITH WATER. GET MEDICAL ATTENTION IN CASE OF INGESTION OR CONTACT WITH EYES. DO NOT INDUCE VOMITING. CHECK "USED BY" DATE ON BOTTLE TO ENSURE BEST PERFORMANCE.

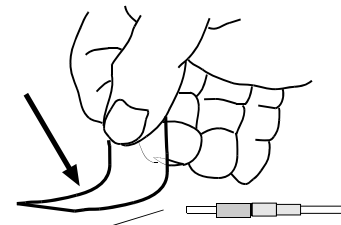

4. DISPOSAL OF BARE FIBERS

WARNING: PICK UP AND DISCARD ALL PIECES OF BARE FIBER WITH STICKY TABS. DO NOT LET CUT PIECES OF FIBER STICK TO CLOTHING OR DROP IN THE WORK AREA WHERE THEY ARE HARD TO SEE AND CAN CAUSE INJURY.

5. LASER LIGHT PROTECTION

WARNING: LASER LIGHT IS INVISIBLE. THE INVISIBLE LIGHT IS POWERFUL ENOUGH TO DAMAGE YOUR EYES. SERIOUS DAMAGE TO THE RETINA OF THE EYE IS POSSIBLE. NEVER LOOK INTO THE END OF A FIBER WHICH MAY HAVE A LASER COUPLED TO IT. SHOULD ACCIDENTAL EYE EXPOSURE TO LASER LIGHT BE SUSPECTED, ARRANGE FOR AN EYE EXAMINATION IMMEDIATELY.

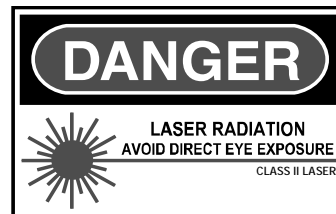

6. CABLE HANDLING

WARNING: FIBER OPTIC CABLE CAN BE DAMAGED BY EXCESSIVE PULLING, TWISTING, CRUSHING OR BENDING STRESSES. CONSULT THE APPROPRIATE SPECIFICATION SHEETS AS PROVIDED BY YOUR CABLE VENDOR. ANY DAMAGE MAY DECREASE OPTICAL PERFORMANCE.

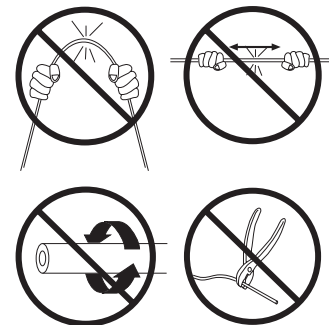

3.0mm Jacketed Cable Termination

1. PREPARING ADHESIVE AND PRIMER

- 1.1 Remove the plunger from a syringe. Squeeze about 0.5ml of FJPHY Anaerobic Adhesive into the back of the syringe barrel. Insert the plunger. Point opening upward, and squeeze any air out of the barrel. Attach needle to syringe. Adhesive that is stored in a syringe may start to harden within 24 hours.

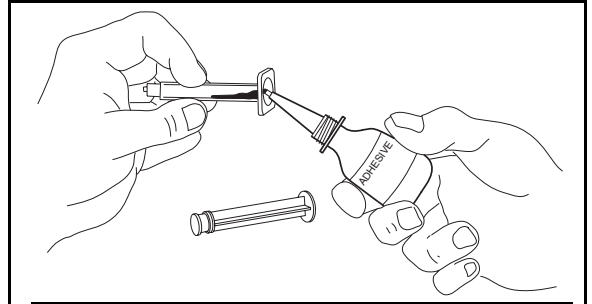

2. STRIPPING 3.0mm JACKETED CABLE

- 2.1 If using duplex cable, split the two cables approximately 6" (152mm) or as needed.
- 2.2 Insert cable through the slotted end of the jacketed boot first, then through the small end of the crimp sleeve. Slide both back out of the way.
- 2.3 Following the stripping dimensions, use the marking pen to mark each cable 1.14" (29mm) and 1.46" (37mm) from the end.
- 2.4 Strip off the cable at the aramid yarn cut mark. To reduce wear on the jacket stripper blades, do not slide the blades along the aramid yarn. Instead, use the tool to cut through the jacket, then pull off the jacket by hand. For 3.0mm jacketed fiber, use the third hole (marked "1.3MM" or #16AWG) from the tip of the jacket stripper.
- 2.5 Cut aramid yarn flush with the end of the jacket.
- 2.6 Strip off the cable at the jacket strip mark. Mark the buffer .93" (23.5mm) from the new jacket edge.

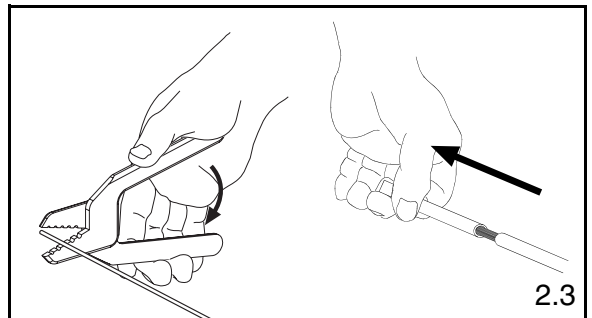
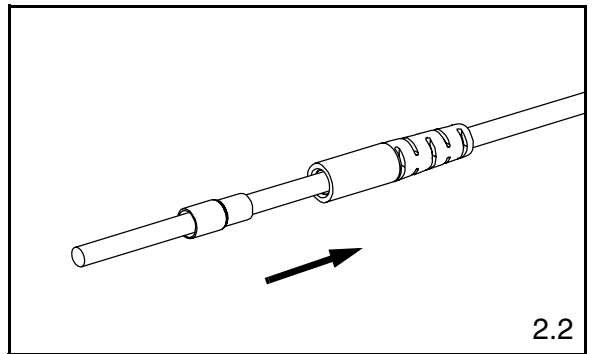
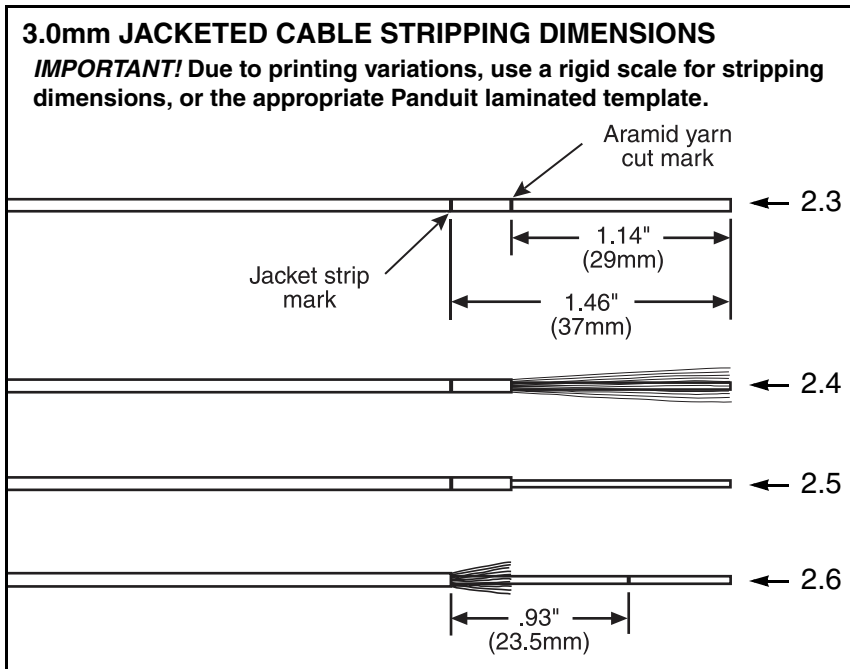
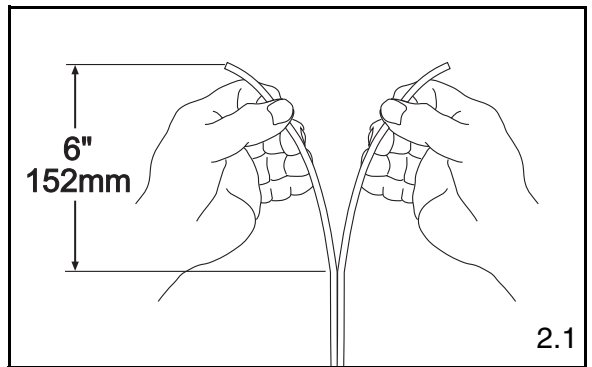
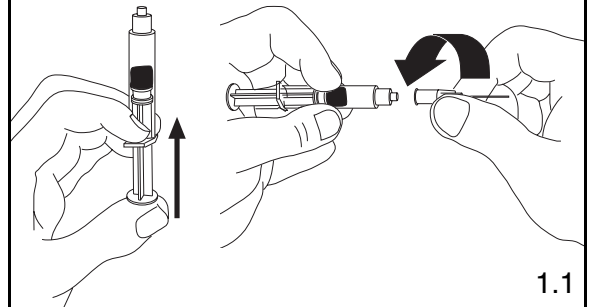

3.0mm JACKETED CABLE STRIPPING DIMENSIONS (cont.)

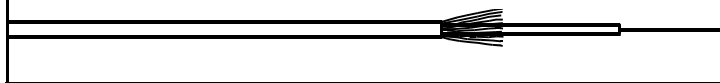

2.7

- 2.7 Using the provided buffer stripper tool, carefully remove the buffer exposing the bare fiber.

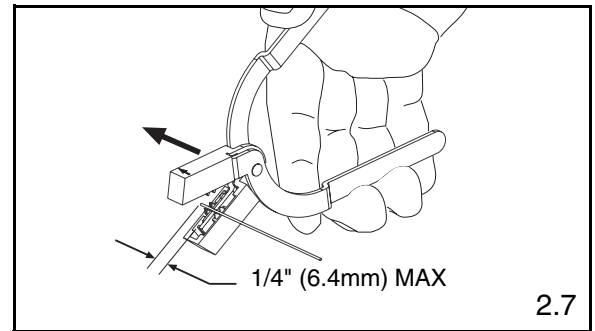

2.7

BUFFER STRIPPING GUIDELINES:

- Panduit recommends that you remove no more than 1/4" (6.4mm) of buffer at a time to avoid breaking the fiber. Refer to cable manufacturer's buffer stripping guidelines for specific recommendations.
- Hold the buffer stripper such that the arrow on the tool points in the direction of buffer removal.
- Noting the location of the tool's blades, position the fiber in the tool's V-notches. Squeeze the handles firmly, and pull tool in the direction of the arrow on the tool.
- Clean the buffer stripper blades after each strip by holding the handles open, pulling the casings back away from the blades, and letting them snap back against the blades.

3. ATTACHING FERRULE TO 3.0mm JACKETED CABLE

Instructions intended for anaerobic adhesive only.

- 3.1 Clean the bare fiber using an alcohol (90% minimum concentration) soaked lint-free wipe. The fibers should be free of all coating and residue. Insert fiber without adhesive or primer into ferrule assembly to ensure a proper fit and to remove any debris which may be blocking the ferrule hole. Remove fiber, clean fiber again, and proceed to the next step.
- 3.2 Apply primer onto the bare fiber with the brush from the primer bottle, and onto the first 1/8" (3.2 mm) of the buffer next to the exposed fiber. Set fiber aside such that it will not collect debris while completing the next three steps.
- 3.3 Insert the needle of the adhesive filled syringe into the rear of the connector assembly until it bottoms against the ferrule.
- 3.4 While pressing the needle firmly against the rear of the ferrule, gently apply pressure on the plunger until a small bead of adhesive forms on the front tip of the ferrule. Wait 3 seconds before removing the needle from the ferrule assembly.
- 3.5 In a smooth motion, carefully insert fiber into the connector assembly and through the ferrule. The fiber is fully inserted when the buffer bottoms against the ferrule. There will be a slight gap between the cable jacket and the backbone. Do NOT force the jacket up against the backbone. The adhesive will begin to set within seconds.
- Note: If adhesive oozes out the back of the assembly, you have injected too much. It is critical to the function of the connector that you wipe away all excess adhesive.**
- 3.6 Allow one minute for the adhesive to harden before cleaving.
- 3.7 Clean the needle using a dry lint-free wipe. The needle should be free of any excess adhesive before preparing the next connector.

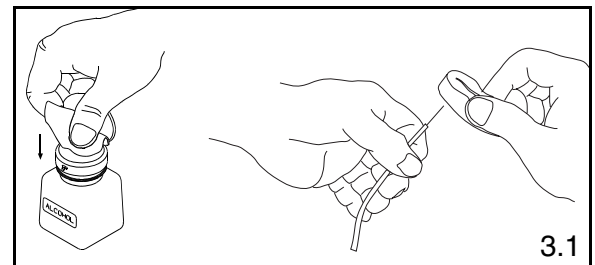

3.1

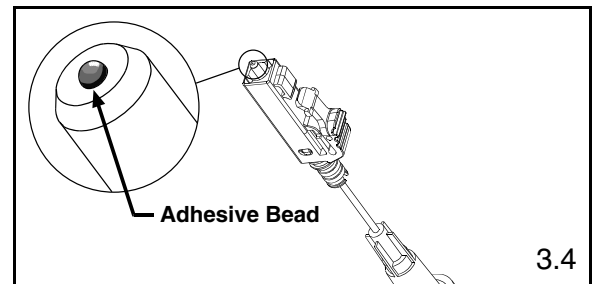

3.4

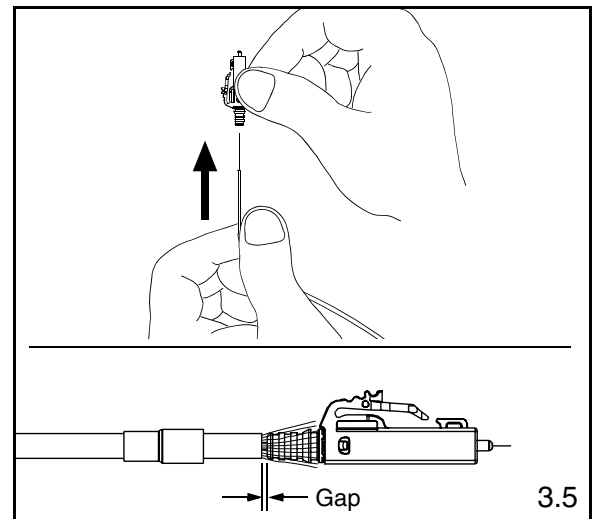

3.5

4. CRIMPING 3.0mm JACKETED CABLE

Note: Be careful not to break the bare fiber protruding from the ferrule during this step.

- 4.1 Flare the aramid yarn **evenly** around the perimeter of the grooved area of the backbone of the ferrule assembly. Use tweezers for best results. There will be a slight gap between the cable jacket and the backbone.
- 4.2 Slide the crimp sleeve over the backbone, trapping the aramid yarn between the crimp sleeve and the grooved area of the backbone.
- 4.3 Align the front edge of the crimp sleeve with the front edge of the crimp die pocket A.

Note: The front edge of the crimp die pocket is the side with the ribs.

- 4.4 Making sure the crimp sleeve is seated against the backbone, crimp the crimp sleeve.

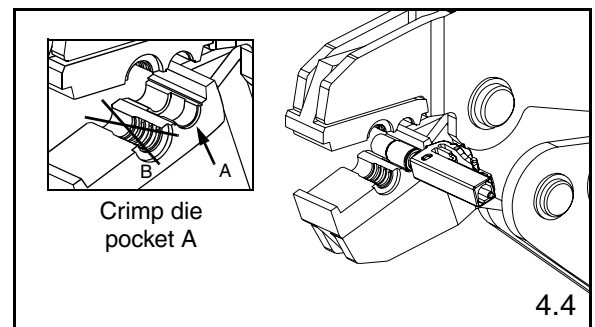
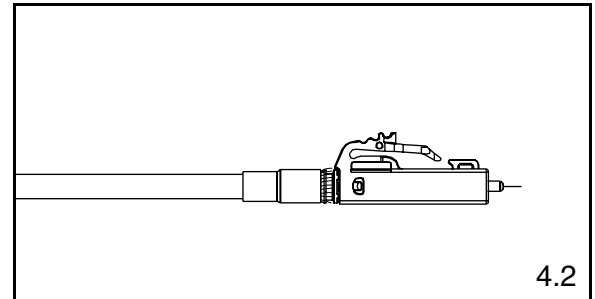
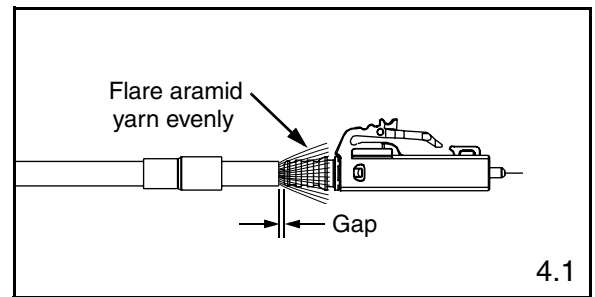

5. CLEAVING 3.0mm JACKETED CABLE

- 5.1 Using a carbide scribe to cleave, gently make one small score mark across the bare fiber just above the endface of the ferrule. Pull the fiber away from the ferrule and discard it on one of the sticky tabs provided. A short stub of fiber will protrude from the tip of the ferrule when viewed through the FLOUPEX10 Eye Loupe.
- 5.2 Clean the carbide blade and fingers using a dry lint-free wipe. This will prevent contamination of the connector during polishing and final assembly.

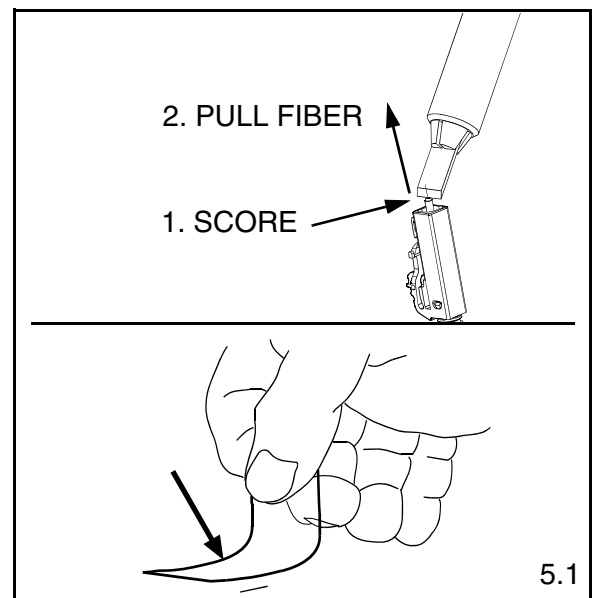
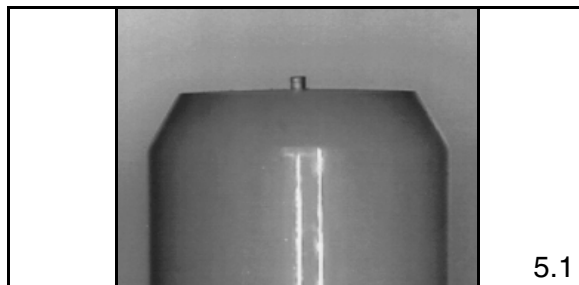

6. POLISHING 3.0mm JACKETED CABLE

Carefully read this entire section before proceeding.

POLISHING GUIDELINES

- Keep the puck flat against the polishing film.
- Figure eights should be about 3" tall and 1.5" wide.
- Always polish on a clean area of the 1 μ m diamond polishing film, with figure eights traversing the film as shown in Figure 6.4.
- One sheet of 5 μ m (micron) polishing film will polish 2-4 ferrules.
- One sheet of 1 μ m diamond polishing film will polish 100 ferrules.
- One sheet of .05 μ m lapping film will polish approximately 18-20 ferrules.
- Clean the polishing puck and pad with a clean wipe moistened with alcohol after each step.
- DO NOT OVERPOLISH.

6.1 Hold a piece of 5 μ m Aluminum Oxide polishing film in the air and gently rub cleaved fiber stub against the film. Using a circular motion, continue rubbing until the end of the fiber is even with the end of the ferrule or adhesive bead. An indication of this is when the stub no longer leaves white traces on the film.

Note: Make sure to hold film so that your fingers are supporting the edges only and are not positioned directly behind fiber.

6.2 Thoroughly clean polishing puck and 85 durometer polishing pad using an alcohol soaked wipe. Place a sheet of 1 μ m diamond polishing film on the pad. Wet film by placing a quarter-sized amount of distilled water in the center of the pad.

6.3 Carefully insert connector into the polishing puck until the connector latches. Insure that the ferrule is protruding from the hole in the underside of the puck. It may be necessary to unlatch and reinsert the connector if the ferrule does not slide through initially.

6.4 Place the puck in the center of the distilled water on the pad. Keeping the puck flat against the film and pad, apply even pressure and polish by making figure eight motions. Continue for 3-4 figure eights.

6.5 Turn the puck over and inspect for any remaining adhesive, indicated by a dark color at the center of the ferrule. Repeat step 6.4 for 1-2 figure eights if adhesive is still present, then reinspect.

6.6 Clean the ferrule tip and puck with an alcohol soaked lint-free wipe. Clean the 1 μ m diamond polishing film using an alcohol soaked wipe after every 5 connectors.

6.7 Inspect the fiber endface using a microscope. If scratches remain, polish for an additional 1-2 figure eights on the 1 μ m diamond film and reinspect.

WARNING: NEVER LOOK INTO THE END OF A FIBER WHICH MAY HAVE A LASER COUPLED TO IT.

Note: Each time a mating takes place, clean the ferrule endface thoroughly with an alcohol soaked lint-free wipe.

6.8 **For singlemode only:** Place a sheet of the .05 μ m lapping film on the pad. Apply several drops of distilled water onto the center of the film.

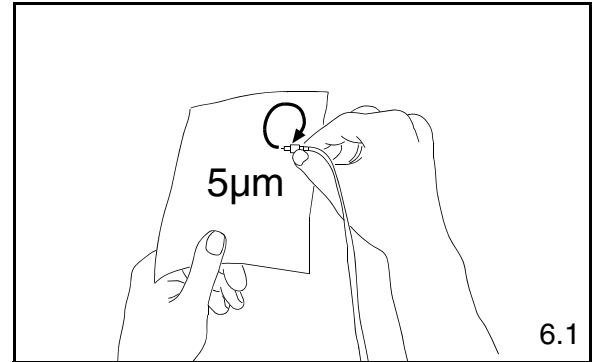

6.1

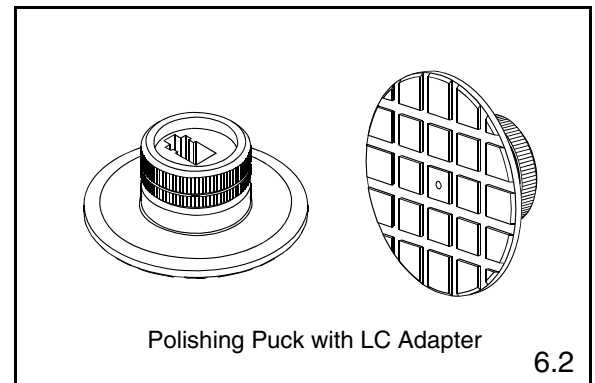

Polishing Puck with LC Adapter

6.2

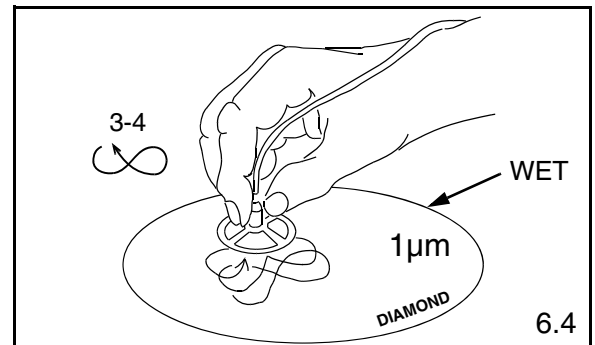

6.4

Ferrule Tip After 1 μ m Diamond Polish

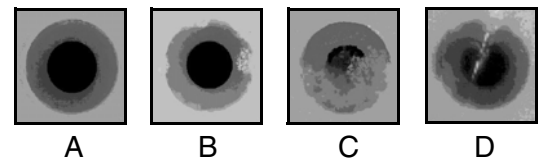

- A = Ideal. No blemishes on core or cladding.
 B = Good. Cladding is chipped, but core is not.
 C = Poor. Scratch across core. Try repolishing or else reterminate.
 D = Unacceptable. Fiber has shattered. Reterminate.

6.5

- 6.9 **For singlemode only:** Place the puck in the center of the distilled water on the film and pad. Keeping the puck flat against the film and pad, apply even pressure and **ONE TIME ONLY** drag the puck in a straight line 0.625" (16mm).
CAUTION: Do not exceed 0.625" (16mm) to avoid fiber undercut
- 6.10 **For singlemode only:** Wipe the ferrule tip, pad and puck with a **dry** wipe.
- 6.11 **For singlemode only:** Clean the ferrule with a distilled water soaked wipe. **Do not use alcohol to clean after using the .05µm lapping film.**
- 6.12 Place a dust cap over the ferrule assembly.

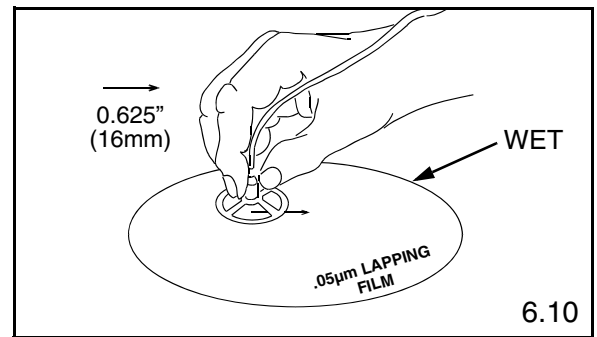

7. ASSEMBLING CONNECTOR AND BOOT

- 7.1 Slide the boot over the crimp sleeve and onto the backbone. Push the boot over the flange towards the shoulder. The boot should snap in place onto the flange.

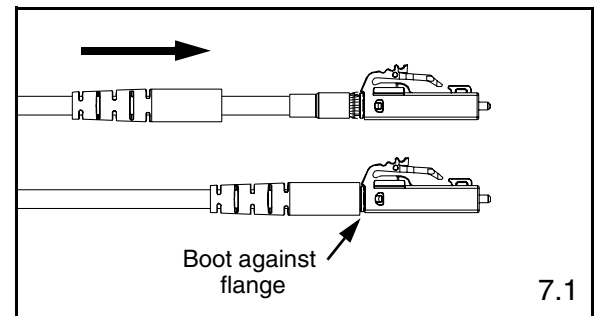

8. ATTACHING DUPLEX CLIP

- 8.1 With a connector held as shown (latch on top, ferrule facing away), insert the connector into one side of the duplex clip as shown (clip held with the 'A->B' polarity marking upright and facing forward). The upper tab of the clip should slide into the pocket underneath the latch of the connector, and the lower tab should slide under the connector housing and "snap", locking it into place.
- 8.2 Repeat this procedure for the other connector, completing the duplexing step.

Note: When making cable assemblies, be sure to follow the correct 'A->B' polarity cross-over between connectors.

