



FIBERRUNNER 12x4 ROUTING SYSTEM WITH QUIKLOCK COUPLER

Part Numbers: FR12X4, FRHC12, FRCR12, FRBC12X4, FRT12X4, FRTSC12, FRA12X4, FRRASC12, FRH4512X4, FRH45SC12, FRFWC12X4, FRFWCSC12, FRIV4512X4, FROVRA12X4, FROVRASC12, FROV4512X4, FROV45SC12

INSTALLATION INSTRUCTIONS

© Panduit Corp. 2004

Printed in U.S.A.

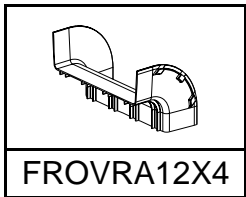
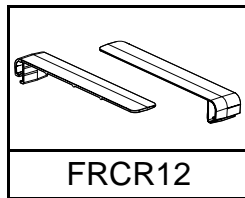
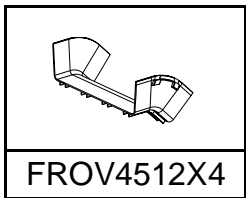
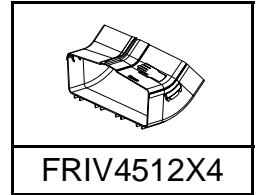
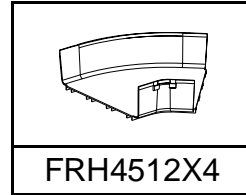
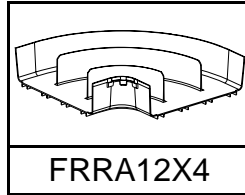
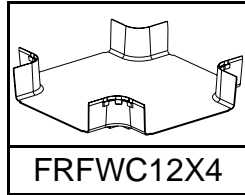
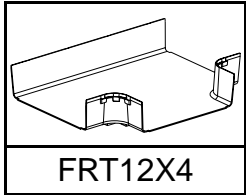

FIBERRUNNER 12x4 CABLE RETAINER INSTALLATION INSTRUCTIONS

1. Insert the cable retainer into the FR12X4 channel.

1a. Detail view showing the cable retainer being pushed into the channel.

2. Push the cable retainer fully into the channel.

3. The cable retainer is now seated in the channel.

-or-

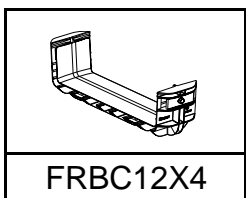

FIBERRUNNER 12x4 QUIKLOCK COUPLER INSTALLATION INSTRUCTIONS

1. Insert the FRBC12X4 coupler into the channel.

2. Push the coupler into the channel.

3. The coupler is now seated in the channel.

Fitting-to-Duct Application

3a. Fitting-to-Fitting Application

3b. Duct-to-Duct Application

Disassembly Instructions

1. Loosen the coupler at 4 places.

2. Push the coupler out of the channel.

3. The coupler is removed from the channel.

For Technical Assistance, Call: 866-405-6656

FIBERRUNNER 12x4 ROUTING SYSTEM INSTALLATION INSTRUCTIONS

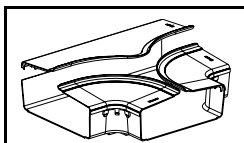

FRTSC12
(SPLIT COVER FOR
FRT12X4)

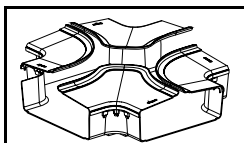

FRFWCSC12
(SPLIT COVER FOR
FRFWC12X4)

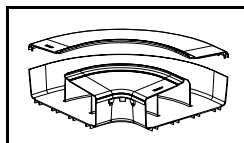

FRRASC12
(SPLIT COVER FOR
FRR12X4)

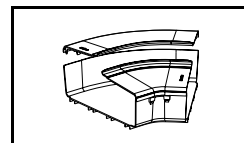

FRH45SC12
(SPLIT COVER FOR
FRH4512X4)

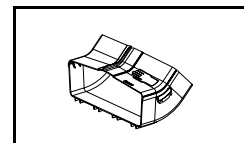

FRIV4512X4
(SPLIT COVER
INCLUDED)

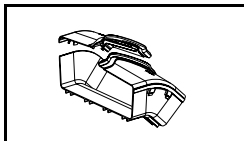

FROV45SC12
(SPLIT COVER FOR
FROV4512X4)

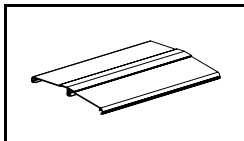

FRHC12
(HINGED COVER FOR
FR12X4)

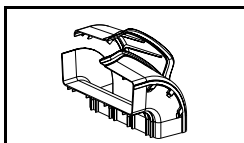

FROVRASC12
(SPLIT COVER FOR
FROVRA12X4)

FIBERRUNNER 12x4 HINGED COVER INSTALLATION AND HINGE OPERATION INSTRUCTIONS

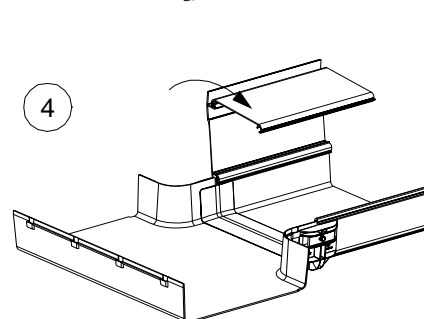
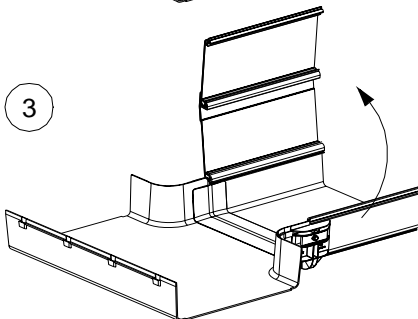
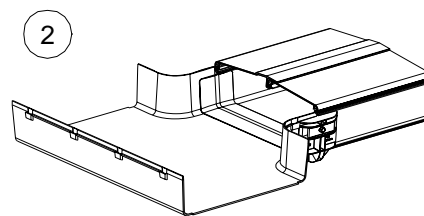
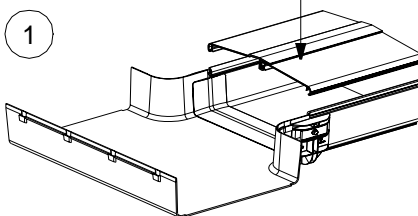

FIBERRUNNER 12x4 INSIDE VERTICAL 45 CABLE INSTALLATION INSTRUCTIONS

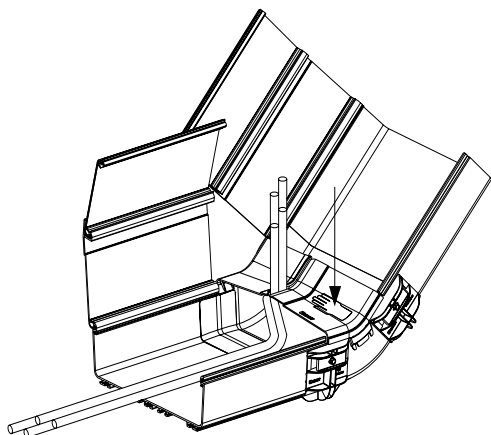

FIBERRUNNER 12x4 FOUR-WAY CROSS SPLIT COVER INSTALLATION INSTRUCTIONS

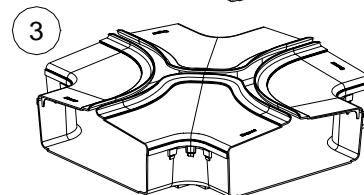
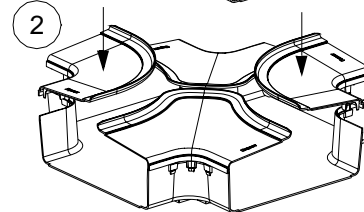
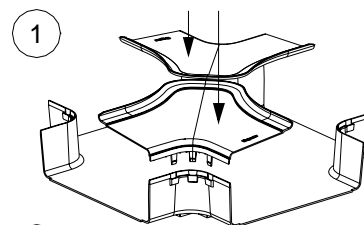

Instruction Sheet RW133

WORLDWIDE SUBSIDIARIES AND SALES OFFICES

17301 Ridgeland Avenue
Tinley Park, IL 60477-3901
Web Site: www.panduit.com/ngc



RACEWAY SYSTEMS DIVISION

Fax: 866-449-1702
Technical Support: 866-405-6656
E-mail: netconnsupport@panduit.com