



# FIBERRUNNER 6x4 Cable Routing System with QUIKLOCK Coupler

Part Numbers: FRH456X4, FRH45SC6, FRRA6X4, FRRASC6, FRT6X4, FRTSC6, FRFWC6X4, FRFWCSC6, FRIV456X4, FRIVRA6X4, FROV456X4, FROV45SC6, FROVRA6X4, FROVRASC6, FR6X4, FRCR6, FRBC6X4, FRHC6, FRSHC6

## INSTALLATION INSTRUCTIONS

© Panduit Corp. 2000

Printed in U.S.A.

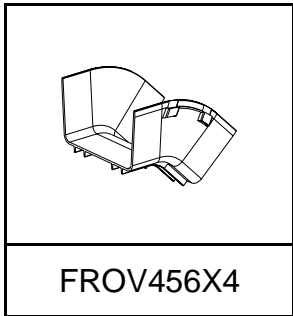
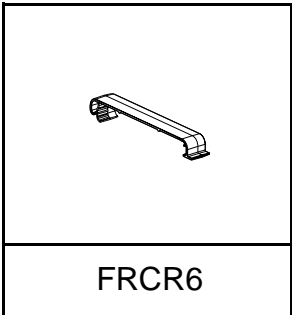
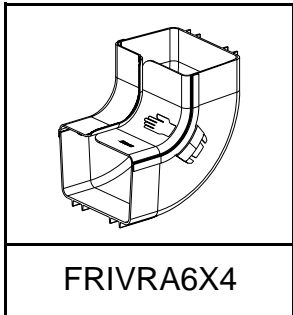
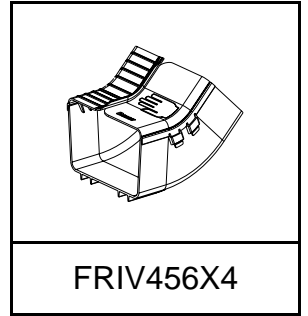
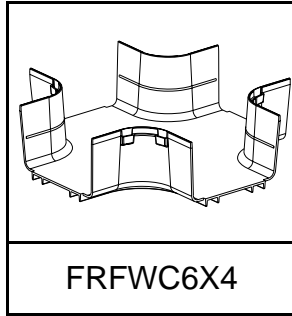
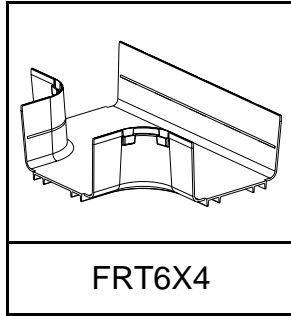
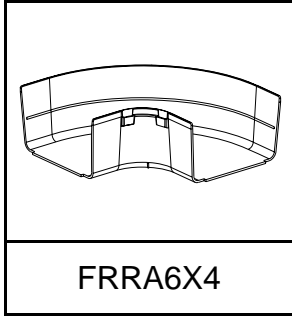
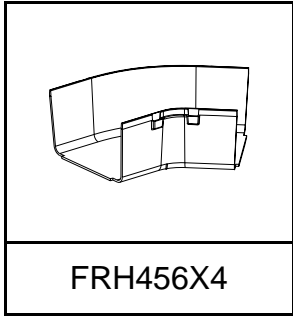

### FIBERRUNNER 6x4 Cable Retainer Installation Instructions

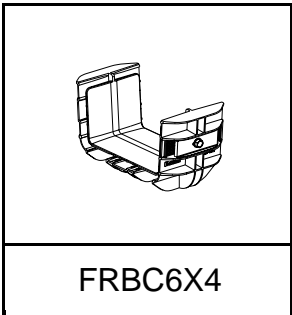
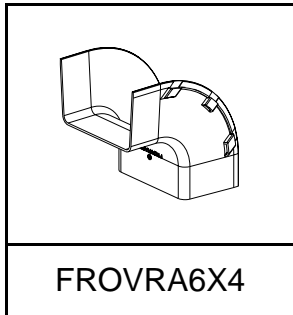
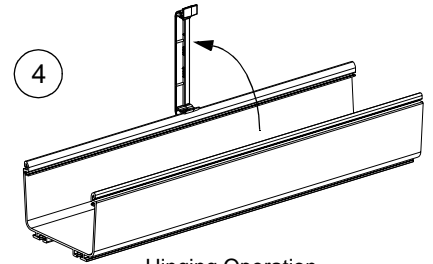
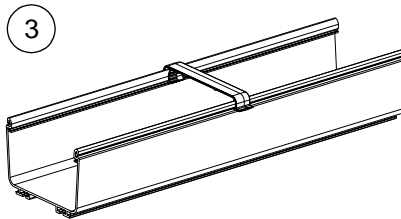
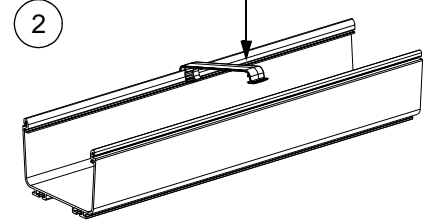
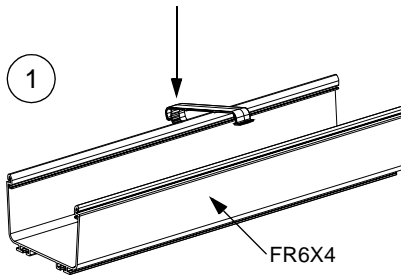

### FIBERRUNNER 6x4 QUIKLOCK Coupler Installation Instructions

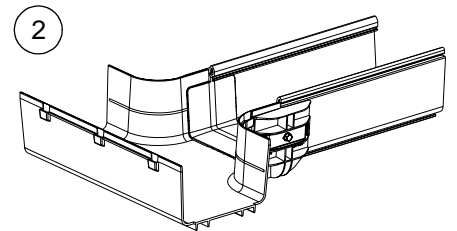
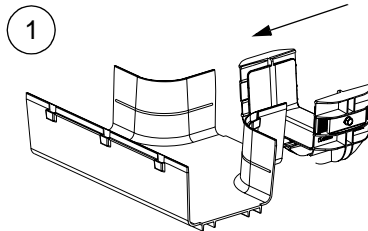

Fitting-to-Duct Application

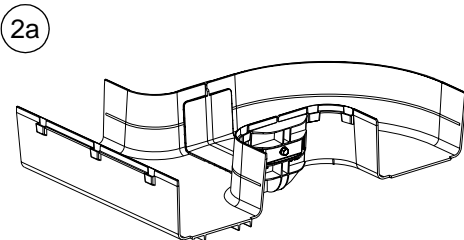

Fitting-to-Fitting Application

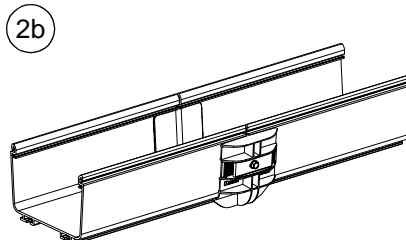

Duct-to-Duct Application

### Disassembly Instructions

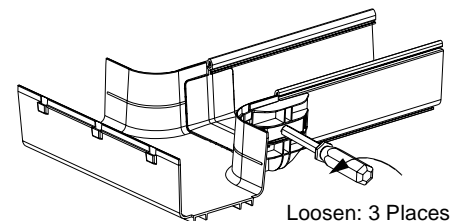

For Technical Assistance, Call: 866-405-6656

# INSTALLATION INSTRUCTIONS

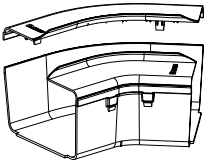

**FRH45SC6**  
Split Cover for FRH456X4

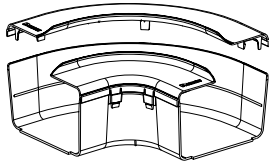

**FRRASC6**  
Split Cover for FRR6X4

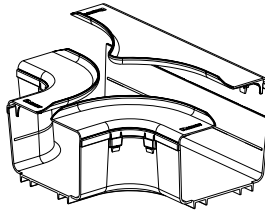

**FRTSC6**  
Split Cover for FRT6X4

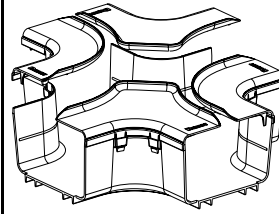

**FRFWCSC6**  
Split Cover for FRFWC6X4

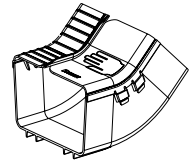

**FRIV456X4**  
Cover Included

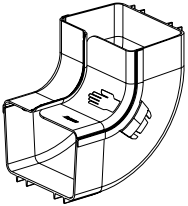

**FRIVRA6X4**  
Cover Included

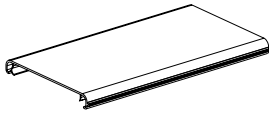

**FRHC6**  
Solid Cover for FR6X4

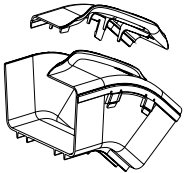

**FROV45SC6**  
Split Cover for FROV456X4

## FIBERRUNNER 6x4 Hinged Cover Installation Instructions

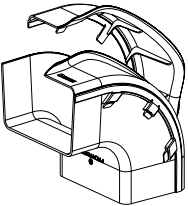
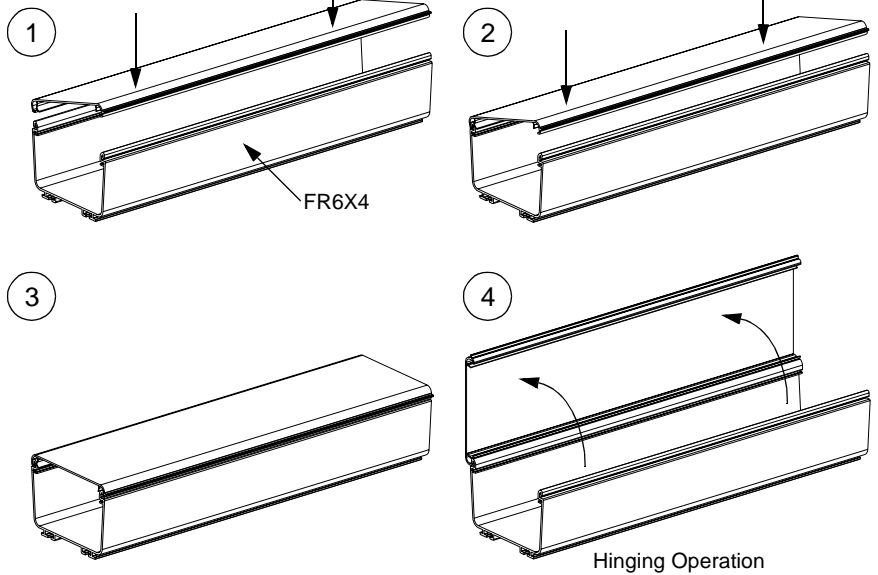

**FROVRASC6**  
Split Cover for FROVRA6X4

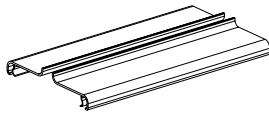

**FRSHC6**  
Split Cover for FR6X4

## FIBERRUNNER 6x4 Split Hinged Cover Installation Instructions

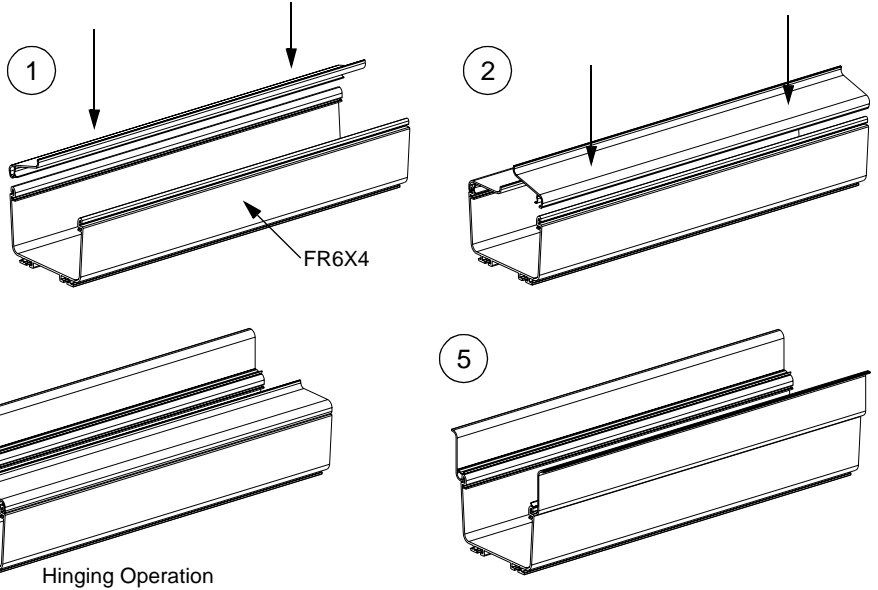

Instruction Sheet RW112B

## WORLDWIDE SUBSIDIARIES AND SALES OFFICES

17301 Ridgeland Avenue  
Tinley Park, IL 60477-3901  
Web Site: [www.panduit.com/ngc](http://www.panduit.com/ngc)



Fax: 866-449-1702  
Technical Support: 866-405-6656  
E-mail: [netconnsupport@panduit.com](mailto:netconnsupport@panduit.com)