

THIS COPY IS PROVIDED ON A RESTRICTED BASIS AND IS NOT TO BE USED IN ANY WAY DETRIMENTAL TO THE INTERESTS OF PANDUIT CORP.

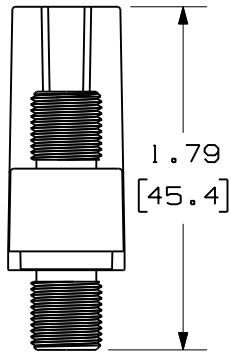

F-TYPE PLUG  
(NOT INCLUDED)

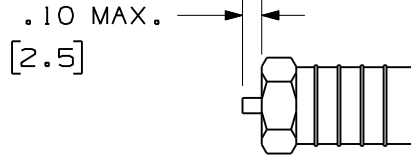

CENTER CONDUCTOR  
SHALL NOT EXCEED  
DIMENSION SHOWN ABOVE.

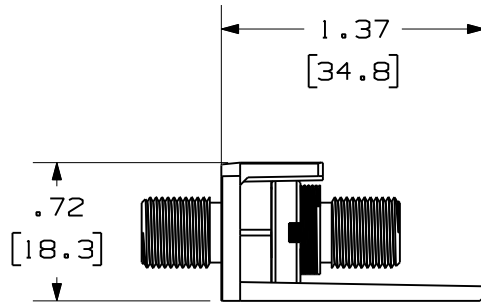
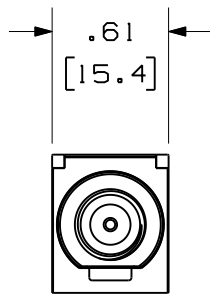

PANDUIT P/N	WEIGHT
CMFSR**Y	.40 LB/10 PCS (181.3 g/10 PCS)

NOTES:

1. SEE CURRENT CATALOG FOR ADDITIONAL PART NUMBER SUFFIXES TO INDICATE COLOR AND OR PACKAGE QUANTITY.
2. SEE CATALOG FOR COMPLETE LIST OF PARTS APPLICABLE FOR USE WITH THIS PART.
3. DIMENSIONS IN ( ) ARE IN METRIC.
4. PART INCLUDES:
  - 1- MODULE BASE
  - 1- SELF TERMINATING F-TYPE COUPLER (ASSEMBLED TO MODULE BASE)
  - 1- SPANNER NUT (ASSEMBLED TO MODULE BASE)

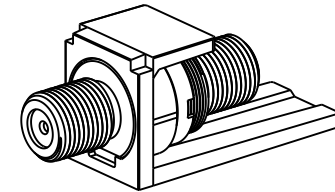

MODEL FILENAME	M00790AC_SELFTERM/00	SIZE	A
DRAWING FILENAME	M02479GV_DC180/00B		

MINI-COM SELF TERMINATING F-TYPE  
MODULE CUSTOMER DRAWING

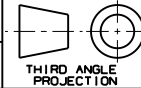
 <b>PANDUIT</b> ™ CORP. TINLEY PARK, ILL 60477	I.I. NUMBER	N/A
	PRODUCT SPEC	N/A
 THIRD ANGLE PROJECTION	WORK INSTRUCTION	N/A
	SCALE	NONE
DRAWN BY	MATERIAL:	PART NO.
DATE	COUPLER- NICKEL PLATED MODULE BASE- ABS	CMFSR**Y
CHK'D		DRAWING NO.
		02479-180

REV	DATE	BY	CHK	DESCRIPTION	ECN	R	CUST	SUP	OTH
I	5-21-09	JsP	TCK	A. ADDED VIEW OF F-TYPE PLUG WITH CUT LENGTH DETAILS.	02479-180	TCK	TCK		TCK
R	8-8-06	JsP	MJD	RELEASED TO PRODUCTION	02479-180	MJD	MJD		MJD