



# READY™ SPLIT SLEEVE

## APPLICATIONS

READY™ SPLIT SLEEVES are used to protect or support cables in both non-rated and rated construction.

READY™ SPLIT SLEEVES are suitable for use in all common constructions including concrete floors, concrete walls, concrete block walls, and gypsum board/stud wall assemblies up to 10" (250 mm) thick.

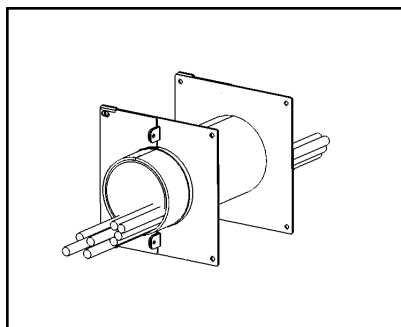
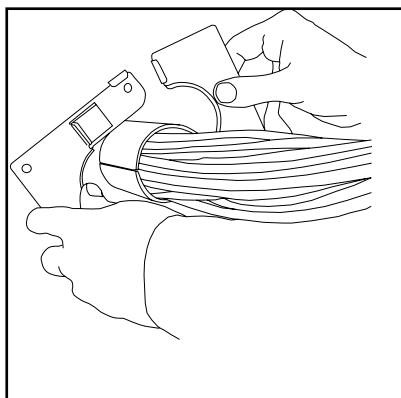

## PRODUCT DESCRIPTION

READY™ SPLIT SLEEVES are a complete UL® Classified out-of-the-box solution for new or existing cable penetrations through walls. Each sleeve kit contains a precut split metallic sleeve, split mounting escutcheons, split intumescent escutcheon gaskets, wall warning labels, and the amount of putty required to seal both ends.

READY™ SPLIT SLEEVES are simple in design and installation. Each trade size includes a unique rolled lip design to eliminate potential sharp edges and do away with the need for conduit bushings.

READY™ SPLIT SLEEVES are sized to the same O.D. as standard EMT (Electrical Metal Tubing) and will accept EMT accessories such as grounding bushings. Additionally, READY™ SPLIT SLEEVES provide an easy method for compliance with the sleeve attachment requirements of the 2000 IBC Section 711.2 without the need for struts or other bracing.

### FEATURES

- **Split Design** — For use with existing cables.
- **Oversize Openings** — UL Tested for larger and irregularly shaped openings
- **Ready to Install** — No cutting required, no waste!
- **Locks Into Place** — No support struts and clamps required
- **No external firestop seal required** — Factory supplied intumescent firestop gasket
- **Firestop Putty Provided with Kit** — Sufficient to seal ends to 1" (25 mm) depth
- **UL Classified and Code Compliant**
- **For Rated and Non-Rated Barriers** — Putty seal impedes the passage of fire, smoke, superheated gases, particulate dust, and minimizes noise transmission

## PERFORMANCE

READY™ SPLIT SLEEVES are UL tested and Classified in accordance with ASTM E814 (UL1479). Systems are available for cable penetrations through common wall constructions up to and including 4 hours.



FILL, VOID OR CAVITY MATERIALS CLASSIFIED BY UNDERWRITERS LABORATORIES INC. © FOR USE IN THROUGH-PENETRATION FIRESTOP SYSTEMS.

SEE UL FIRE RESISTANCE DIRECTORY

CLASSIFIED FILL, VOID, OR CAVITY MATERIALS FOR USE IN THROUGH-PENETRATION FIRESTOP SYSTEMS. SEE UL DIRECTORY OF PRODUCTS CERTIFIED FOR CANADA AND UL FIRE RESISTANCE DIRECTORY

## SPECIFICATIONS

All data, video, communication, power, and control cabling shall be installed through sleeves wherever said cables penetrate fire resistance rated barriers. In the case of existing cable installation, a split sleeve device with corresponding split escutcheon plates to facilitate installation around existing cables shall be used. Sleeves shall be sized to accommodate present cable bundle diameter as well as anticipated growth. Split sleeve kit provided with intumescent gaskets and non-hardening intumescent firestop putty. When irregularly shaped openings are encountered, the split sleeve device shall be UL tested and classified for this purpose. The split sleeve device shall be UL Classified and tested to the requirements of ASTM E 814 (ANSI/UL 1479). Split sleeve kit shall be UL tested in larger or irregularly shaped openings and include provisions for mounting device in such openings.

### SPECIFIED DIVISIONS

Division 7	07 84 00	Through-Penetration Firestopping
Division 26	26 00 00	Electrical

## PHYSICAL PROPERTIES

<b>Available Sizes:</b>	1" (25 mm), 2" (51 mm), and 4" (102 mm)	<b>Putty Fill Material:</b>	SpecSeal® Firestop Putty
<b>Sleeve and Plate:</b>		<b>Color:</b>	Red
<b>Construction:</b>	0.059" (1.5 mm) thick steel (zinc plated)	<b>Odor:</b>	None
<b>Intumescent Gasket:</b>		<b>Solids:</b>	100%
Expansion Temperature:	350°F (177°C)	<b>Expansion Temperature:</b>	230°F (110°C)
Volume Expansion:	15x (free expansion)	<b>Volume Expansion:</b>	8x (free expansion)
In Service Temperature:	130°F (54.4°C)	<b>In Service Temperature:</b>	130°F (54.4°C)
		<b>VOC Content:</b>	0.00 lbs/gal (0.0 g/L)
		<b>Shelf Life:</b>	No Limit



## INSTALLATION INSTRUCTIONS

### EXISTING CABLE BUNDLES

READY™ SPLIT SLEEVES may be installed around existing cable bundles using the steps shown below. Round, rectangular, or irregularly shaped openings are permissible provided opening (with sleeve centered) is inscribed within a circle on both sides of wall not exceeding the max opening size shown in Table A.

1. Capture the existing cable bundle with each half of the split sleeve tube and snap the two halves together. (Fig. 1)
2. Carefully slide sleeve into opening. Center in wall with sleeve extending equidistant from the approximate center line of the wall.
3. Install split intumescent gaskets around sleeve and cable bundle and slide to wall surface. (Fig. 2)
4. Install two-piece split escutcheon plates around sleeve and slide to wall. (Fig. 3)
5. With escutcheon plates held tightly against wall, tighten screws. (Fig. 4)
6. When opening dimensions exceed the minimum opening size specified in Table A, plates shall be secured to wall with steel fasteners. Corners of plate must extend 1" (25 mm) beyond the periphery of the opening of the solid wall surface. For gypsum board walls, use nominal 3/16" (4.8 mm) diameter steel molly-bolts or toggle-bolts. For concrete, use nominal 1/4" (6.4 mm) diameter steel concrete screws (Tapcon® or equivalent).

### FIRESTOP INSTALLATION

Pack ends of sleeve with SpecSeal® Firestop Putty (included). Install putty to a depth of 1" (25 mm). Pack putty completely around cable bundle sealing all gaps and interstices. Install Barrier Labels on both wall surfaces. (Fig. 5)

### CABLE CHANGES AND MAINTENANCE

SpecSeal® Firestop Putty is permanently non-hardening to facilitate the removal or addition of cables. After cable changes, reinstall putty to original depth. NOTE: This product represents a UL Classified Firestop System. Only approved SpecSeal® materials may be used. NO SUBSTITUTIONS ARE PERMITTED.

### TECHNICAL SERVICE

Technical information including Product Data Sheets, Installation Instructions, applicable UL Classified Systems, Certificates of Conformance, and suggested specifications are available at the company's web site ([www.stifirestop.com](http://www.stifirestop.com)). For other information, contact the factory directly by dialing (800) 992-1180.

### PRECAUTIONARY INFORMATION

No unusual hazards are known or expected. Observe normal safety procedures during installation.

### AVAILABILITY

READY™ SPLIT SLEEVES are available from authorized STI distributors worldwide. Consult factory for the names and locations of the nearest sales representatives or distributors. Ordering information is listed below:

### ORDERING INFORMATION

CAT. NO.	DESCRIPTION
FSR100	1" (25 mm) split sleeve, escutcheon plates, gaskets, and putty
FSR200	2" (51 mm) split sleeve, escutcheon plates, gaskets, and putty
FSR400	4" (102 mm) split sleeve, escutcheon plates, gaskets, and putty

### CITY OF NEW YORK MEA 30-92-M

**Table A:**

Catalog Number	Trade Size*	Min. Opening	Max. Opening
FSR100	1" (25 mm)	1.16" (30 mm)	2.25" (57 mm)
FSR200	2" (51 mm)	2.38" (60 mm)	4.0" (102 mm)
FSR400	4" (102 mm)	4.5" (114 mm)	6.0" (152 mm)

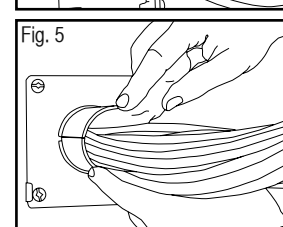
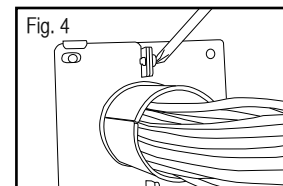
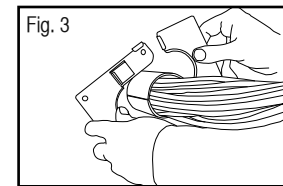
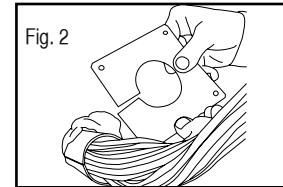
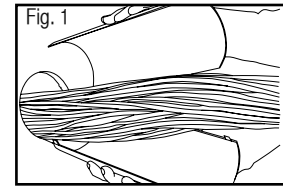

IMPORTANT NOTICE: All statements, technical information, and recommendations contained herein are based upon testing believed to be reliable, but the accuracy and completeness thereof is not guaranteed.

#### WARRANTY

Specified Technologies Inc. manufactures its goods in a manner to be free of defects. Should any defect occur in its goods (within one year), Specified Technologies Inc., upon prompt notification, will at its option, exchange or repair the goods or refund the purchase price.

#### LIMITATIONS AND EXCLUSIONS:

THIS WARRANTY IS IN LIEU OF ALL OTHER REPRESENTATIONS EXPRESSED OR IMPLIED (INCLUDING THE IMPLIED WARRANTIES OF MERCHANTABILITY OR FITNESS FOR USE) AND UNDER NO CIRCUMSTANCES SHALL SPECIFIED TECHNOLOGIES INC. BE RESPONSIBLE FOR ANY INCIDENTAL OR CONSEQUENTIAL PROPERTY DAMAGE OR LOSSES. PRIOR TO USE, THE USER SHALL DETERMINE THE SUITABILITY OF THE PRODUCT FOR ITS INTENDED USE, AND THE USER ASSUMES ALL RISKS AND LIABILITY FOR SUBSEQUENT USE.

No statement or recommendation not contained herein shall have any force or effect unless in an agreement signed by officers of seller and manufacturer.

MADE IN THE USA – COPYRIGHT © 2008 SPECIFIED TECHNOLOGIES, INC.



Specified Technologies Inc. • 200 Evans Way, Somerville NJ 08876 • Phone: 800.992.1180 • Fax: 908.526.9623

