

Installation

1 Connect the Battery

In compliance with Department of Transportation (DOT) regulations, the Back-UPS is shipped with the internal red battery wire disconnected. **The Back-UPS will not operate until the internal red wire is connected to the battery. Once connected, allow the Back-UPS to charge for a full eight hours prior to use.**

Note: Small sparks may occur during battery connection. This is normal.

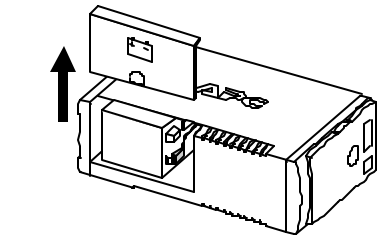

a. Open the battery compartment, as shown.

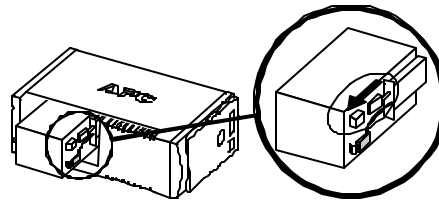

c. Connect the red battery wire to the positive battery terminal.

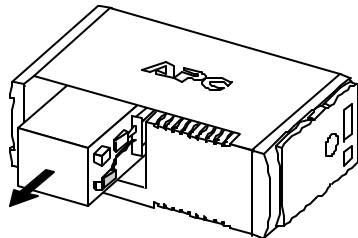

b. Pull the battery about half way out, as shown

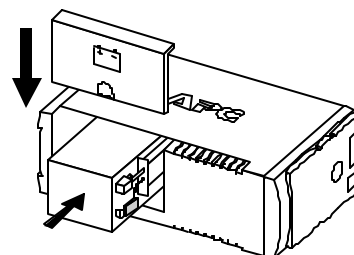

d. Push the battery into the battery compartment and re-install the cover, as shown.

2 Placement / Power

Avoid placing the Back-UPS in:

- Direct sunlight
- Excessive heat
- Excessive humidity or in contact with fluids of any type

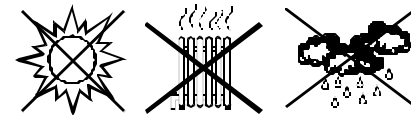

Plug the Back-UPS into a wall outlet, as shown.

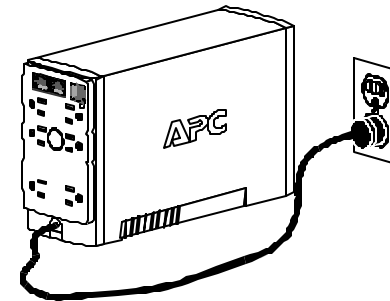

- The Back-UPS charges the internal battery any time it is connected to a wall outlet.

3 Check the Building Wiring Fault Indicator

If the red Building Wiring Fault indicator on the rear panel of the Back-UPS is lit, one of the following conditions exists:

- Open or high resistance ground
- Hot or neutral polarity reversed
- Overloaded neutral circuit

A lit indicator means that a potential shock hazard exists. Improper building wiring should be corrected by a qualified electrician. Do not use the Back-UPS until the condition that caused the fault is corrected.

Note: Improper building wiring will not prevent the Back-UPS from operating, but it will limit its protection capability. It may also result in equipment damage that is not covered by the APC Equipment Protection Policy.

4 Connect Equipment to the Back-UPS

The rear panel of the Back-UPS consists of the following elements:

Battery Back Up Outlets (qty. of 3). These outlets provide battery back-up, surge protection, and Electro-magnetic Interference (EMI) filtering. In case of power outage, battery power is automatically provided to these outlets. Power (utility or battery) is not supplied to these outlets when the Back-UPS is switched **Off**. Connect a computer, monitor, and external disk or CD-ROM drive to these outlets.

Surge Only Outlets (qty. of 3). These outlets are always **On** (when utility power is available) and are not controlled by the **On/Off** switch. These outlets do not provide power during a power outage. Connect a printer, fax machine or scanner to these outlets.

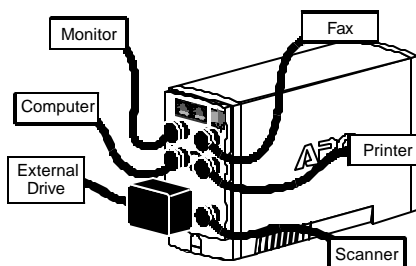

Black Velcro Straps (qty. of 2 - not shown). For convenience, two velcro traps have been included and can be used to manage power cords.

5 Connect the Phone Line to Surge Protection

The telephone ports provide lightning surge protection for any device connected to the telephone line (computer, modem, fax or telephone). The telephone ports are compatible with Home Phone-line Networking Alliance (HPNA) and Digital Subscriber Line (DSL) standards, as well as all modem data rates. Connect as shown.

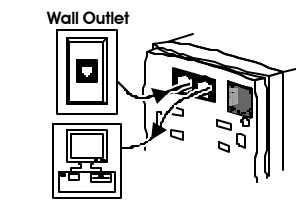

Modem/Phone/Fax

6 Switch On the Back-UPS

Note: Allow the Back-UPS to charge for a full eight hours prior to use.

Press the push-button on the front panel of the Back-UPS.

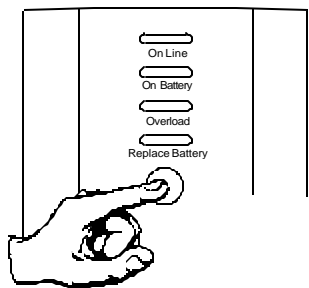

Observe that the following events occur after pressing and releasing the push-button:

- The green **On-Line** indicator flashes.
- The yellow **On Battery** indicator lights while the **Self-Test** is being performed.
- When **Self-Test** has successfully completed, only the green **On Line** indicator will be lit.
- If the internal battery is not connected, (see Step 1 above) the green **On Line** indicator and red **Replace Battery** indicator will light. The Back-UPS will also emit a chirping sound.

7 Connect USB Cable and Install Software (optional)

Note: The Back-UPS software CD-ROM provides data reporting and unattended shutdown of computers connected to the device. The User's Guide contains additional information about the Back-UPS software. The User's Guide is contained in the main folder with the CD-ROM.

Attention: USB Hubs

The Back-UPS should be plugged into the USB port of the computer, not into a USB hub.

The computer must be powered **On** before connecting the USB cable. Connect the USB cable end (USB symbol facing down) to the rear panel USB port of the Back-UPS. Connect the other end of the USB cable to the USB port (usually located on the rear panel of the computer).

For other Microsoft® Windows® or Macintosh® operating systems, please follow the steps below, as appropriate:

Windows 98 and Windows Me Users

Please insert the APC PowerChute® Personal Edition Software CD-ROM included with your Back-UPS into the CD-ROM drive of your

computer. The installation program will load automatically. Please follow the on-screen instructions to install the software.

Windows 2000 Users

The APC PowerChute Personal Edition Software CD-ROM included with your UPS contains a "wizard" that optimizes your system's power settings for operation with your Back-UPS. It does this by changing various settings in Power Options Properties in the Control Panel. APC strongly advises you to reconfigure your system by running this wizard.

1. Insert the APC PowerChute Personal Edition Software CD-ROM into the computer's CD-ROM drive.
2. Choose "Start" and then the "Run" option. Type: <CD-ROM drive letter>:\setup.exe. Click "OK" and follow the instructions.

Microsoft Windows XP Users

Please visit the APC website at www.apc.com/windowsxp for updates on the availability of Windows XP software.

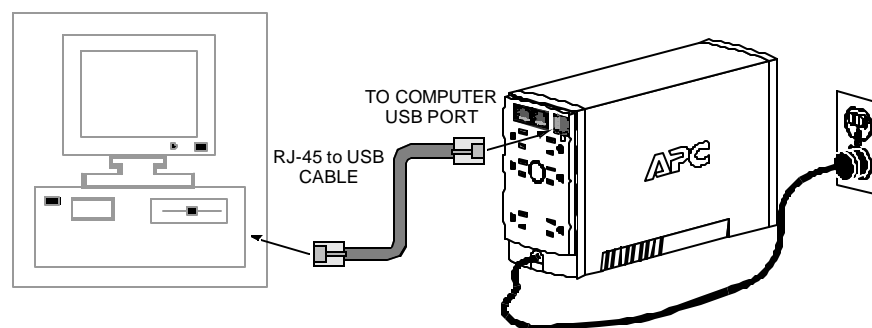

Mac OS 9 (9.0.4/9.1 or higher) Users

APC PowerChute Personal Edition Software has been designed specifically to work with Mac OS 9 (9.0.4/9.1 or higher). There are builds of Mac OS 9 prior to Mac OS 9.0.4/9.1 with power drivers that have known problems, so please make sure that you have the most up to date version of Mac OS 9 (9.0.4/9.1 or higher).

Insert the APC PowerChute Personal Edition Software CD-ROM into the CD-ROM drive. An icon called "APC Shutdown Manager v1.0.1" will appear on your desktop. Open the folder and double-click the "ReadMe" file. Make sure your hardware matches the requirements stated in the ReadMe file. Double-click on "APC Shutdown Manager v1.0.1" to begin the installation of the software. At the first dialog, click on "Continue". Read the displayed license agreement and click "Accept" if you agree to the terms. Click on "Install" to begin. After installation, click on the "Restart" dialog button to restart your computer.

All Other Users

The software is designed for the Windows and Macintosh operating systems mentioned in this section. If you do not have one of these operating systems, your unit will still provide these primary features:

- Battery backup, surge protection, and telephone line protection to protect your entire desktop from lightning and power surges.
- Runtime needed for you to work through brief power disturbances: provides time to manually save data and shut down safely.

Installation of the APC PowerChute Personal Edition Software is not mandatory. However, other features provided by the software include unattended automatic operating system shutdown, as well as application data saving. To activate these features, install the software as previously discussed.

Status Indicators and Alarms

There are four status indicators (lights) on the front panel of the Back-UPS (On Line, On Battery, Overload, and Replace Battery).

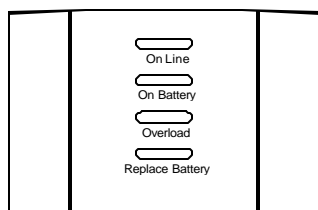

On Line (green) - is lit whenever utility power is powering the Battery Backup outlets.

On Battery (yellow) - is lit whenever the battery of the Back-UPS is powering equipment connected to the Battery Backup Outlets.

Four Beeps Every 30 Seconds - this alarm is sounded whenever the Back-UPS is running On Battery. Consider saving work in progress.

Continuous Beeping - this alarm is sounded whenever a low battery condition is reached. Battery run-time is very low. Promptly save any work in progress and exit all open applications. Shutdown the operating system, computer and the Back-UPS.

Overload (red) - is lit whenever power demand has exceeded the capacity of the Back-UPS.

Continuous Tone - this alarm is sounded whenever the Battery Backup outlets are overloaded.



Circuit Breaker - the circuit breaker button located on the rear panel of the Back-UPS will stick out if an overload condition forces the Back-UPS to disconnect itself from utility power. If the button sticks out, disconnect non-essential equipment. Reset the circuit breaker by pushing the button inward.

Replace Battery (red) - is lit whenever the battery is near the end of its useful life, or if the battery is not connected (see above). A battery that is near the end of its useful life has insufficient run-time and should be replaced.

Chirps for 1 Minute Every 5 Hours - this alarm is sounded whenever the battery has failed the automatic diagnostic test.

Troubleshooting

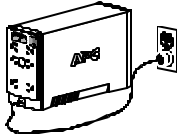
Use the tables below to solve minor Back-UPS installation and operation problems. Consult APC On-line Technical Support or call APC Technical Support for assistance with problems that cannot be resolved using this document:

Possible Cause	Procedure	
Back-UPS will not switch on		
Back-UPS not connected to an AC power source.	Check that the Back-UPS power plug is securely connected to the wall outlet.	
Back-UPS circuit breaker "tripped".	Disconnect non-essential equipment from the Back-UPS. Reset the circuit breaker (located on the rear panel of the Back-UPS) by pushing the circuit breaker button fully inward until it catches. If the circuit breaker resets, switch the Back-UPS on and reconnect the equipment one-at-a-time. If the circuit breaker trips again, it is likely that one of the connected devices is causing the overload.	
Very low or no utility voltage.	Check the wall outlet that supplies power to the Back-UPS using a table lamp. If the lamp bulb is very dim, have the utility voltage checked by a qualified electrician.	

Back-UPS does not power computer/monitor/external drive during an outage

Internal battery is not connected.	Check the battery connections. (See "Connect the Battery" under "Installation" on the front page of this document.
Computer, monitor or external disk/CD-ROM drive is plugged into a Surge Only outlet.	Move computer, monitor, or external drive power cord plug to the Battery Backup outlets.

Back-UPS operates on battery although normal utility voltage exists

Back-UPS circuit breaker "tripped".	Disconnect non-essential equipment from the Back-UPS. Reset the circuit breaker (located on the rear panel of the Back-UPS) by pushing the circuit breaker button fully inward until it catches.	
The wall outlet that the Back-UPS is connected to does not supply utility power to the unit.	Connect the Back-UPS to another wall outlet or have a qualified electrician check the building wiring.	

Back-UPS does not provide expected backup time

Back-UPS is excessively loaded.	Unplug non-essential Battery Backup connected equipment, such as printers and plug them into Surge Only outlets. Note: Devices that have motors or dimmer switches (laser printers, heaters, fans, lamps, and vacuum cleaners, for example) should not be connected to the Battery Backup outlets.
Back-UPS battery is weak due to recent outage and has not had time to recharge.	Charge the battery. The battery charges whenever the Back-UPS is connected to a wall outlet. Typically, eight hours of charging time are needed to fully charge the battery from total discharge. Back-UPS run-time is reduced until the battery is fully charged.
Battery requires replacement.	Replace battery (see Order Replacement Battery). Batteries typically last 3-6 years, shorter if subjected to frequent power outages or elevated temperatures.

A red indicator is lit

Battery is not connected properly.	Check the battery connections. Consult "Connect the Battery" under "Installation" on the front page of this document. It shows how to access the battery and connect the wires.
The Overload indicator is lit if equipment connected to the Battery Backup outlets is drawing more power than the Back-UPS can provide.	Move one or more equipment power plugs to the Surge Only outlets.
Battery requires replacement.	The battery should be replaced within two weeks (see "Order Replacement Battery"). Failure to replace the battery will result in reduced run-time during a power outage.

Red indicators are flashing

Back-UPS failure.	Call APC for service.
-------------------	-----------------------

Replace Battery indicator lit and an alarm sounds when the Back-UPS is turned on

Internal battery not connected.	Check the battery connections. Consult "Connect the Battery" under "Installation" on the front page of this document. It shows how to access the battery and connect the wires.
---------------------------------	---

Specifications

Input Voltage (on line)	98 - 132 Vac
Frequency Limits (on line)	47 - 63 Hz (autosensing)
On Battery Waveshape	Stepped Sine Wave
Maximum Load	350 VA - 210 W 500 VA - 300 W
Typical Recharge Time	8 Hours
Operating Temperature	32° to 104°F (0° to 40°C)
Storage Temperature	23° to 113°F (-5° to 45°C)
Operating and Storage Relative Humidity	0 to 95% non-condensing
Size (H x W x D)	6.5 x 3.6 x 11.2 inches (16.5 x 9.2 x 28.5 cm)
Weight	350 VA - 12.5 lb (5.7 kg) 500 VA - 13.8 lb (6.3 kg)
Shipping Weight	350 VA - 14.0 lb (6.4 kg) 500 VA - 15.3 lb (7.0 kg)
EMI Classification	FCC/DOC Class B Certified
On Battery Run-Time	20 Minutes typical - desktop computer and 15 inch (38.1 cm) monitor.

Back-UPS Storage

Before storing, charge the Back-UPS for at least eight hours. Store the Back-UPS covered and upright in a cool, dry location. During storage, recharge the battery in accordance with the following table:

Storage Temperature	Recharge Frequency	Charging Duration
23° to 86°F (-5° to 30°C)	Every 6 months	8 hours
86° to 113°F (30° to 45°C)	Every 3 months	8 hours

Please contact APC Technical Support to troubleshoot the unit before returning it to APC.

Order Replacement Battery

The typical battery lifetime is 3-6 years (depending on the number of discharge cycles and operating temperature). A replacement battery can be ordered over the phone from APC, or the battery can be ordered on-line from the APC web site (see below, a valid credit card is required).

When ordering, please specify Battery Cartridge **RBC2**.

Battery Replacement

Battery replacement is a safe procedure. The Back-UPS can be left on with the equipment connected during this procedure. Do not replace the battery when the Back-UPS is On Battery. Refer to the APC Safety Guide for additional information.

Please consult the "Connect Battery" diagrams (a through d) on the front page of this document when performing the following procedures:

- While viewing the Back-UPS from the front, lay the Back-UPS on its left side (diagram a).
- Slide the battery compartment cover off of the Back-UPS (diagram a).
- Grasp the tab attached to the battery and slide the battery partially out of the case. Grab the battery firmly and pull it straight out. The battery wires will disconnect as the battery is pulled out (diagram b).
- Carefully unpack the new battery. Retain the packing carton so that the old battery can be recycled.
- Insert the new battery halfway into the Back-UPS (diagram d).
- Connect the wires to the new battery as follows:
- Red Wire - to red (positive) terminal
- Black Wire - to black (negative) terminal
- Note: Small sparks at the battery terminals are normal during connection.
- Carefully insert the battery fully into the Back-UPS.
- Slide the battery compartment cover back into place.
- The Replace Battery indicator will shut off within the 14-day self-test interval, or when the Back-UPS is switched On.

The old battery must be recycled. Deliver the battery to an appropriate recycling facility or return it to APC in the packing carton that came with the new battery. Additional recycling information is provided with the new battery.

Service

If the Back-UPS arrived damaged, notify the carrier.

If the Back-UPS requires service, do not return it to the dealer. The following steps should be taken:

- Consult the Troubleshooting section to eliminate common problems.
- Verify that the circuit breaker is not tripped. A tripped circuit breaker is the most common Back-UPS problem.
- If the problem persists, consult APC On-line Technical Support or call APC Technical Support (see below).
 - When calling APC Technical Support, have the Back-UPS model number, serial number and date of purchase available. Be prepared to troubleshoot the problem over the phone with an APC Technical Support representative. If this is not successful, APC will issue a Return Merchandise Authorization (RMA) number and a shipping address.
 - A Back-UPS under warranty will be repaired at no cost. The standard warranty is two (2) years from the date of purchase. APC's standard procedure will be to replace the original unit with a factory reconditioned unit. APC will ship the replacement unit once the defective unit has been received by the repair department, or cross ship upon the receipt of a valid credit card number. The customer pays for shipping the unit to APC. APC pays ground freight transportation costs to ship the replacement to the customer.
 - Customers who must have the original unit back due to assigned asset tags and set depreciation schedules must declare such a need at first contact with an APC Technical Support representative.
 - If the warranty has expired, there is a repair charge.

For return:

- Disconnect the red battery terminal wire from the Back-UPS battery (see "Connect the Battery" instructions and graphics on the front of this document). Department of Transportation (DOT) regulations require that the battery wire be disconnected before shipping the Back-UPS to APC.
- Pack the Back-UPS in its original packaging. If the original container is not available, contact APC Technical Support to obtain a new set. Pack the Back-UPS properly to avoid damage in transit.
- Never use styrofoam beads for packaging. Damage sustained in transit is not covered under the warranty (insuring the package for full value is recommended).
- Write the RMA number on the outside of the package.
- Return the Back-UPS to APC by insured, prepaid carrier to the address provided by APC Technical Support.

Warranty

The standard warranty is two (2) years from the date of purchase. APC's standard procedure is to replace the original unit with a factory reconditioned unit. Customers who must have the original unit back due to assigned asset tags and set depreciation schedules must declare such a need at first contact with an APC Technical Support representative. APC will ship the replacement unit once the defective unit has been received by the repair department, or cross ship upon the receipt of a valid credit card number. The customer pays for shipping the unit to APC. APC pays ground freight transportation costs to ship the replacement to the customer.

APC Contact Information

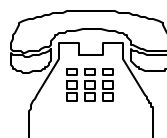

USA/Canada	1.800.800.4272
Mexico	292.0253 / 292.0255
Brazil	0800.12.72.1
Worldwide	1.401.789.5735
Internet	http://www.apc.com
Technical Support	http://www.apc.com/support